

High-End/Data Center Servers

Sun Enterprise Overview

Product specifications	Sun Enterprise 10000		
CPUs	4-64		
Processor			
Clock speed / External Cache	336-MHz/4MB 400-MHz/8MB		
Board slots	16		
CPU for performance¹	16	32	64
Main memory	512 MB-64 GB		
Maximum disk capacity			
– Internal	288 GB		
– External	Over 60 TB (per domain)		
I/O slots	4-64 (SBus) 2-32 (PCI)		
I/O channels	2-32 (SBus) 2-32 (PCI)		
I/O channel bandwidth	3.2GB/sec	3.2GB/sec	3.2GB/sec
System bus bandwidth (sustained/peak)	10.5 GBps @ 83.3-MHz 12.8 GBps @ 100-MHz		
Redundant power and cooling	Y	Y	Y
Hot plug system components	Y	Y	Y
Hot swap system components	Y	Y	Y
Operating system	Solaris 2.5.1, 2.6, Solaris 7, Solaris 8		
System monitor	HostView		
Warranty³	1 year hardware 1 year software 4-hour phone response 4-hour onsite response		
Installation	ServerStart Install Included		
¹ 400-MHz with 8-Mbyte external cache, 100-MHz Gigaplane speed (Enterprise 6500 numbers are based on 80-MHz Gigaplane speed) ² Relative Performance compared to a single 336-MHz UltraSPARC-II CPU with 4-Mbyte external cache (value = 1.0) ³ may vary by geography			

Enterprise 10000 Ordering Flow Chart

Each step represents a **required/recommended** line item on a Sales Order

Step 1 - required



Step 2 - required

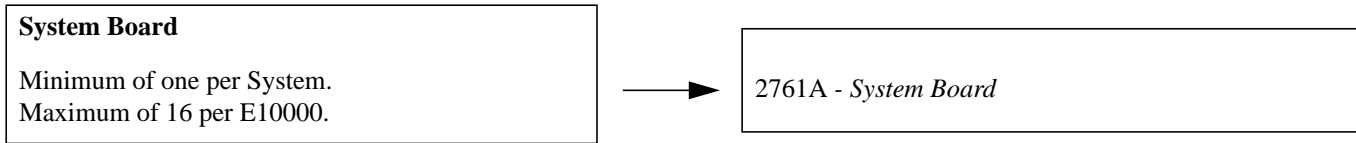

Step 3 - required

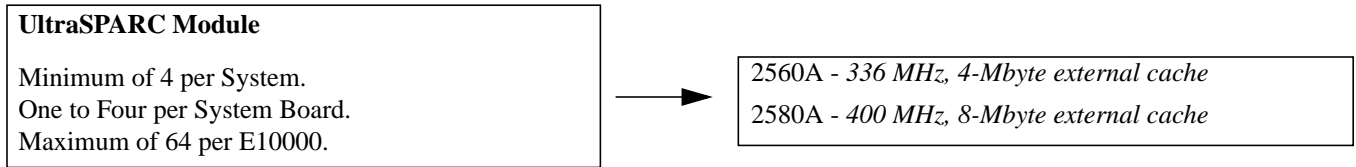

Step 4 - required

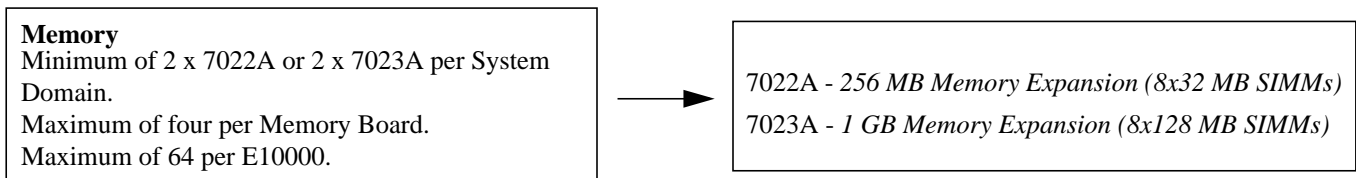

Step 5 - required

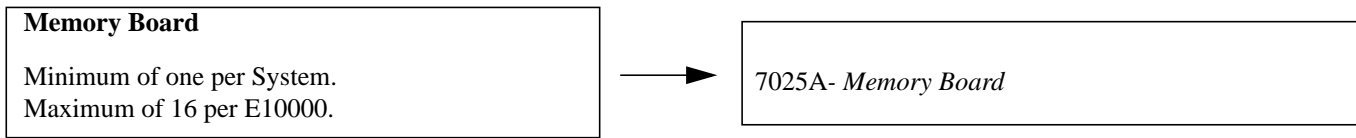

Step 6 - required

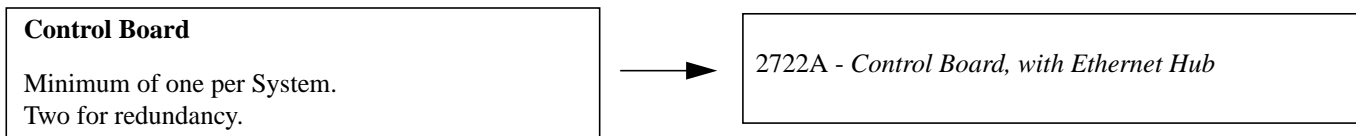

Step 7 - required

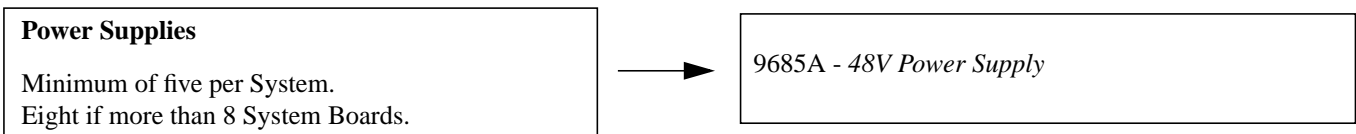

Enterprise 10000 Ordering Flow Chart *(continued)*

Each step represents a **required/recommended** line item on a Sales Order

Step 8 - required

AC Breakers
 Minimum of three per System.
 Four if more than eight System Boards.



3875A - AC input module



Step 9 - required

Cooling Fans
 Minimum of ten per System.
 16 if more than 8 System Boards.



9671A - Fan tray



Step 10 - optional

Power Control Module/2nd AC sequencer
 Up to five power control modules per system.
 One second AC power sequencer.



9681A - Power Control Module w/cable
 9620A - Optional 2nd AC power sequencer



Step 11 - required

System Service Processor (SSP)
 Minimum of one per System.
 Two for redundancy.



2754A - System Service Processor Ultra 5
 2755A - System Service Processor E250
 (See SSP notes.)



Step 12 - required

SSP Country Kits
 Order one per SSP



Choose from:
 3508A - North American/Universal Type 6 country kit
 3530A - European Universal Type 6 country kit
 3509A - French Type 6 country kit
 3510A - German Type 6 country kit
 3514A - United Kingdom Type 6 country kit



Step 13 - required

Software
 Order must include 1 Version of Solaris to be used in the domains, SSP Software, and the Solaris version to specifically to reside on the SSP (See SSP notes)



Domain software:
 SOLMS-26EW9999 - Solaris 2.6 Server edition
 SOLMS-07EW9999 - Solaris 7 Server edition
 SOLS-2.5.1NOV97 - Solaris 2.5.1 Server edition
 SOLZS-080B9AY9 - Solaris 8
SSP software:
 SSP9S-320-SAM9 - SSP software 3.2 (CD release)
 SOLMS-07DW9999 - Solaris 7 Server edition (SSP 3.1.1 is located on the supplemental disk)



Step 14 - required

I/O Board (SBus or PCI)
 Minimum of one per System.
 Maximum of 16 per Enterprise 10000.
 Any Mix allowed



2730A - Dual SBus I/O Board
 2731A - Dual PCI I/O daughter Board

Enterprise 10000 Ordering Flow Chart *(continued)*

Each step represents a **required/recommended** line item on a Sales Order

Step 15 - optional

Internal Disk Storage options

Maximum of 2 StorEdge D1000's in E10000 system cabinet. Maximum of 16 UniPack disks and 4 UniPack trays in E10000 system cabinet

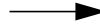

Choose from:

- SG-ARY147A-36GR4 - 36GB StorEdge D1000
- SG-ARY154A-72GR4 - 72GB StorEdge D1000
- SG-DSK010C-9G - 9.1-Gbyte 10K rpm StorEdge UniPack
- 9645A - StorEdge UniPack tray
- 902A - 2-meter 68-pin SCSI cable



Step 16 - optional

Interfaces and Host Adapters

These options may be required to support configured mass storage and tape devices (optional).

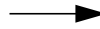

Choose from:

- 1148A - SBus ATM-155/UTP Host Adapter
- 1062A - SBus DWIS/S Host Adapter
- 1063A - SBus SWIS/S Host Adapter
- 1065A - SBus Ultra DWIS/S Host Adapter (Req for Internal Storage - 1 per D1000 Tray)
- 1071A - HPPI PCI Network Interface Card
- 1140A - SBus Gigabit Ethernet 2.0 Adapter
- 1141A - PCI Gigabit Ethernet 2.0 Adapter
- 1073A - SBus Cluster interconnect card (SCI)
- 1049A - Quad FastEthernet SBus Card (QFE)
- 1142A - SBus SAS FDDI 6.0 Adapter
- 1143A - SBus DAS FDDI 6.0 Adapter
- 1059A - SBus Fast Ethernet Adapter 2.0
- 1146A - SBus Serial Parallel Controller (SPC/S)
- 1018A - SBus SunSwift 100BaseT Adapter
- X1145A - SBus High-Speed Serial Interface (HSI/S)
- 1147A - SBus SunATM-155/MFiber Adapter 2.0
- 1149A - SBus SunATM-622/MFiber Adapter
- 2144A - Token Ring Interface/SBus (TRI/S) Card
- 6730A - FC-AL SBus Host Adapter



Step 17 - required

Power Cord for System

Minimum of three.
Maximum of four per Cabinet.
Order 4 if more than 8 System Boards.

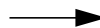

Choose one:

- 3865A - Power Cord, U.S. Version
- 3851A - Power Cord, International Version



Step 18 - required

Power Cord for AC sequencers in System Cabinet

One required. Two if a 2nd AC sequencer.



Choose one:

- 3800A - Power Cord, U.S. Version
- 3848A - Power Cord, International Version



Enterprise 10000 Ordering Flow Chart *(continued)*

Each step represents a **required/recommended** line item on a Sales Order

Step 19 - optional

Capacity-On-Demand System Board Package

Minimum of one per E10000-4 System.
Must have ordered at least 20 400MHz CPU modules.

2860A - *Capacity-On-Demand System Board Package includes: 1-system board (2761A), 4 UltraSPARC Modules 400MHz 8-Mbyte external cache (2580A) 2 GB Memory (7023A), 1 memory board (7025A) and 1 dual SBus I/O board (2730A)*



Step 20 - required, if Capacity-On-Demand Boards are ordered

License for ordered RTU CPUs

Required if an order includes Capacity-On-Demand System Board Package.

E10000-COD-CONVERT - *Order quantity must include the number of CPUs ordered in the E10000 system (quantity = number of CPUs ordered)*



Step 21 - optional, if Capacity-On-Demand Boards are ordered

License for RTU CPUs for Capacity-On-Demand System Board Package

E10000-RTU-TIER2 - *One RTU License for One 400MHz 8-Mbyte UltraSPARC Module. Order for RTU CPU licenses for Capacity-On-Demand System Board Package*



Step 22- required, if Capacity-On-Demand Boards are ordered

Software

E10000-SW-COD-1.0 - *E10000 Capacity-On-Demand software v1.0 for web release and all documentation*



Step 23- required

Submit Configuration to DHPG SalesDesk, with E10000 Configuration Diagram.

<http://sales-desk.West/>

Enterprise 10000 Power Express Ordering Flow Chart

Each step represents a **required/recommended** line item on a Sales Order

Step 1 - required

Server Base Package
Select only one



E10000-D - Enterprise 10000 Power Express Base Package includes: 8 power supplies (9685A), 4 AC input modules (3875A), and 16 fan trays (9671A)

E10000-C - Enterprise 10000 Capacity-On-Demand Base Package includes: 8 power supplies (9685A), 4 AC input modules (3875A), 16 fan trays (9671A), and includes a RTU license to use 8 UltraSPARC 400MHz 8-Mbyte Modules.



Step 2 - required

System Board Package
Order either 5 or 8 per system



2861A - System Board E10000 System Board Package includes: 1-system board (2761A), 4 UltraSPARC Modules 400MHz 8-Mbyte external cache (2580A), 2 GB Memory (7023A), 1 memory board (7025A), and 1 dual SBus I/O board (2730A).

2860A - Capacity-On-Demand System Board Package includes: 1-system board (2761A), 4 UltraSPARC Modules 400MHz 8-Mbyte external cache (2580A), 2 GB Memory (7023A), 1 memory board (7025A), and 1 dual SBus I/O board (2730A).



Step 3 - required

Control Board
Order 2 per system



2722A - Control Board, with Ethernet Hub



Step 4 - required

System Service Processor (SSP)
Order 1 per system



2754A - System Service Processor (Ultra 5)
(See SSP note)



Step 5 - required

Interfaces and Host Adapters
Order 2 each per system



1065A - SBus Ultra DWISIS Host Adapter (Required for Internal Storage - 1 per D1000 Tray)

1049A - Quad FastEthernet SBus Card (QFE)



Step 6 - required

Internal Disk Storage Options
Order 2 per system



SG-ARY147A-36GR4 - 36GB StorEdge D1000

3800A-Power Cord US Version

3848A-Power Cord International Version



Enterprise 10000 Power Express Ordering Flow Chart (cont.)

Each step represents a **required/recommended** line item on a Sales Order

Step 7 - required

SSP Country Kits
Order 1 per system



Choose from:
3508A - North American/Universal Type 6 country kit
3530A - European Universal Type 6 country kit
3509A - French Type 6 country kit
3510A - German Type 6 country kit



Step 8 - required

Power Cord for System
Order 4 per system



Choose from:
3865A - Power Cord, U.S. Version
3851A - Power Cord, International Version



Step 9 - required

Software
Order must include 1 Version of Solaris 2.6 to be used in the domains, SSP 3.1.1 Software, and the Solaris 7 8/99 version to specifically reside on the SSP. (See SSP notes), E10000 Capacity-On-Demand Software (only if a E10000-C base package is ordered).
Note: The SSP software supported with E10000 Capacity-On-Demand is SSP 3.1.1, 3.2, 3.3



Domain software:
SOLMS-26EW9999 - Solaris 2.6 Server edition
SSP software:
SOLMS-070W9999 - Solaris 7 Server edition 8/99 (SSP 3.1.1 is located on the supplemental disk)
E10000-SW-COD-1.0 - E10000 Capacity-On-Demand software v1.0 for web release and all documentation



Step 10 - optional

License for additional RTU CPUs for E10000-C only



E10000-RTU-TIER1 - One RTU License for One 400MHz 8-Mbyte UltraSPARC Module. Order for additional RTU CPU licenses for E10000-C base package up to 20 RTU licenses (note: E10000-C includes 8 RTU CPU Licenses)

E10000-RTU-TIER2 - One RTU License for One 400MHz 8-Mbyte UltraSPARC Module. Order for RTU CPU licenses for Capacity-On-Demand System Board Package



Step 11 - required

Submit Configuration to DHPG SalesDesk, with E10000 System Board Configuration Diagram.
<http://sales-desk.West/>

Enterprise 10000 System Configuration Guidelines

General Comments

- Qualified service personnel must use the approved cushioned Sun ESD Mat to provide proper protection when installing options and memory on the System Board. Contact your Sun sales representative for information.

Capacity-On-Demand Ordering Requirements

- Capacity-On-Demand System Board Package includes: 1 system board (2761A), 4 UltraSPARC Modules 400MHz 8-Mbyte external cache (2580A), 2 GB Memory (7023A), 1 memory board (7025A), and 1 dual SBus I/O board (2730A).
- Capacity-On-Demand System Board Package does not include any RTU CPU license(s), must be ordered separately.
- Order must include Capacity-On-Demand 1.0 Software.
- Order must have at least 20 UltraSPARC Modules, 400MHz 8-Mbyte external cache (2580A).
- Order must include SSP software version 3.1.1

Base Package

- Sun Enterprise 10000 Base Cabinet, cage for 16 System Boards, Peripheral space with power sequencer, Solaris license for unlimited users, Licenses for AP, SSP and Sun Enterprise NetBackup software.
- No System Board, no UltraSPARC Modules, no Memory Board, no I/O Boards, no Disk.
- E10000 Power Express System must follow configuration guidelines as specified within the E10000 Power Express Ordering flowchart. Any deviations will from the ordering flowchart will be per standard E10000 leadtimes.

UltraSPARC Module

- Minimum of 4 UltraSPARC Modules per system. Each System Board can have one to four UltraSPARC Modules. Cache sizes may not be mixed on any one System Board.
- Different frequency modules may not be mixed within the E10000.

Memory Board

- Each System Board has space for one Memory Board.
- Each Memory Board has space for two or four memory expansion options (One or three not permitted).
- Each memory expansion option includes eight SIMMs.
- Two types of memory expansion are supported per E10000. They may not be mixed on a Memory Board.

Board Slots

- Sixteen System slots in Enterprise 10000 plus two slots for Control Boards.
- Minimum is one System Board and one Control Board.

System Board

- Four empty UltraSPARC Module slots, space for a Memory Board, space for an I/O Board.
- Minimum of one per system. Maximum number of System Boards is 16.

I/O Boards (SBus or PCI)

- The SBus I/O Board has two SBus channels supporting four empty SBus slots.
- The PCI I/O Board has two 64 bit, 66 MHz, PCI channels supporting two empty PCI slots.
- Each I/O Board is mounted on a System Board.
- Only one I/O Board per System Board.
- Minimum of one SBus I/O board per system.
- SBus and PCI I/O Boards may be configured in any mix within one E10000.

Enterprise 10000 System Configuration Guidelines *(cont.)*

Control Board

- The Control Board is packaged with an Ethernet cable and a rack mounted Ethernet hub. The latter is used for private communication between the Control Board and the SSP.
- A second Control Board is recommended for redundancy. The switchover from primary to secondary is manual.

Power and Cooling

- 8 System Boards or less, require 3 AC Breaker + Filter assemblies, five 48 volt power supplies and 10 fan trays.
- More than 8 System Boards require 4 AC Breaker + Filter assemblies, 8 48 volt power supplies and 16 fan trays.
- If System Boards are located in the front and back of the E10000 system, 4 AC Breaker + Filter assemblies, 8 48 volt power supplies and 16 fan trays are required.
- Second AC power sequencer. This is recommended if there are two rack mounted Ethernet hubs or if power redundancy is required for disks mounted with the E10000 cabinet.

Power Control Module (PCM)

- An optional component to allow AC power to expansion cabinets to be switched on and off from the SSP.
- Multiple Sun expansion cabinets can be controlled by one PCM.

System Service Processor (SSP)

- A second SSP may be ordered for redundancy. The failover from the primary SSP to the secondary SSP is manual.
- SSP software version 3.2 or 3.3 supports InterDomain Network. The Operating System required for SSP 3.2 or SSP 3.3 are only Solaris 2.6, Solaris 7 or Solaris 8.
- The Operating System required for SSP 3.1.1 can be Solaris 2.5.1, 2.6 and Solaris 7 (SSP 3.1.1 is also available for free download from the web).

Disk Trays

- The SBus Ultra Differential F/W Intelligent SCSI Host Adapter (1065A) is the preferred adapter for the StorEdge D1000 tray. Use two adapters for a split SCSI bus.
- Up to two StorEdge D1000 trays per Enterprise 10000. Each is supplied with one 2 meter SCSI cable (902A).
- If the E10000 already has one RSM disk tray packaged, there is space for just one D1000 tray.
- One extra 68-pin SCSI cable (902A) is required if connecting a D1000 in a split SCSI bus configuration.
- Substitute 12 meter SCSI cables (979A) if connecting a D1000 in a E10000 system cabinet to system board slots 8 through 15.

UniPack boot disks

- Each UniPack tray (9645A) accomodates up to 4 UniPack 9.1 GByte disks. Tray includes AC power cables for the disks.
- Up to four trays (for 16 disks) can be mounted within the E10000 cabinet. Or two trays and one D1000. Or two trays and one RSM disk subsystem.
- For maximum availability, mirror each UniPack disk, provide it with its own dedicated adapter and use redundant AC power (order optional 2nd AC sequencer).
- The second AC sequencer is required for UniPack trays three and four.
- UniPack disks must use a SCSI single ended SBus adapter (SWIS/S, model 1063A or SunSwift model 1018A).
- Mirrored UniPack disks may be daisy chained from one adapter to save adapter slots. Avoid if possible as there is no protection against adapter failure.
- Order one 2 meter SCSI cable (902A) for each UniPack.
- Due to SCSI cable length restrictions, UniPacks mounted on the front side of the system have to be cabled to adapters on the front side of the system, and the same for UniPacks mounted on the back side of the system. Because of this requirement, extra UniPack trays may have to be configured. An example is if you have four drives connecting to board slots 0-7, you must order two UniPack trays.
- Sun StorEdge Volume Manager is the preferred software to use with the UniPack boot disks.

Enterprise 10000 System Configuration Guidelines *(cont.)*

Interfaces and Host Adapters for tape

- A 68pin SCSI Connector is required per every StorEdge Library. This can be provided with the SWIS/S card (1063A), SunSwift card (1018A) or UltraSCSI (1065A).

Power Cord

- One required for every AC Breaker + Filter assembly. Models 3865A (US) or 3851A (International).
- One required per AC sequencer mounted internal to the Enterprise 10000. Order 3800A (US) or 3848A (International).

Software Licensing

- Software Licensing policies on the E10000 become more complex if more than one Domain is being used. Policies vary according to the specific software package being placed on the system. At this point in time, many software product units have not developed explicit policies for a multi domain E10000. Please refer to the product manager for the product in question for more information.

Dynamic System Domains

- Each Enterprise 10000 may be logically configured with up to eight Domains.
- Each Domain must have its own boot device and 10/100baseT network to connect it to the SSP.
- Each Domain must have its own copy of Solaris. Different revisions are permitted (from those currently being supported). One copy of Solaris may be replicated up to seven times to support Domains.

Boot devices

- The Enterprise 10000 must be configured with sufficient Sun StorEdge disk (9.1 GB minimum) to allow each Domain to be booted.

Other configuration rules

- The Token Ring SBus board, order number 1144A, requires a dedicated SBus. Therefore the adjacent slot must be left empty. The second SBus on the I/O board is not affected and both of its slots may be used.
- Sunswift (1018A), Fast Ethernet (1059A) and Gigabit Ethernet 1.0 (1045A) SBus cards have the following restriction. They must only be placed in slot positions zero and two on any Enterprise 10000 I/O SBus board. The other two slots may be used without restriction.
- SCI Cluster (1073A) and Ultra Differential F/W SCSI (1065A) SBus cards cannot reside on the same SBus channel.

DHPG Sales Desk

- The function of this organization is to check each Enterprise 10000 configuration for legitimacy and for satisfaction of customer's requirements (<http://sales-desk.West/>)
- Each Enterprise 10000 order must be accompanied by a configuration diagram that adds information missing from the order. For example: number of Domains, how the disk devices are connected to SBus boards, etc.

Enterprise 10000 Sample Configurations

Enterprise 10000 Configuration

<i>Quantity</i>	<i>Order Number</i>	<i>Description</i>
1	E10000-4	Enterprise 10000 Server Base Package, Ultra Enterprise 10000 Base Cabinet, cage for 16 System Boards, Peripheral space with power sequencer, Solaris license for unlimited users, Licenses for AP, SSP
3	3865A or 3851A	Power Cords
1	SOLMS-26EW9999	Solaris 2.6 HW 5/98 for Servers
1	SOLMS-070W999	Solaris 7 HW 8/99 for Servers (for the System Service processor)
1	2754A	System Service Processor
1	various	SSP Country Kit
1	2722A	Control Board, with Ethernet Hub
3	3875A	AC Breaker and Filter assy
5	9685A	48 volt power supply
10	9671A	Fan tray
1	9681A	Power Control Module
4	2761A	System Board
16	2580A	Processor Modules, 400-MHz with 8MB external Cache
4	2730A	Dual SBus I/O Board
1	1049A	Quad FastEthernet SBus Card (QFE)
4	7025A	Memory Board - unpopulated
8	7022A	256-Mbyte Memory expansion
1	SG-ARY147A-36GR4	36GB StorEdge D1000
1	1065A	SBus Ultra Differential F/W Intelligent SCSI Host Adapter
1	3800A/3848A	Power Cord for E10000 internal I/O
Enterprise 10000 with sixteen 400-MHz/8MB UltraSPARC Processors, 2-Gbyte of Memory and 36-Gbyte of internal disk storage		

Enterprise 10000 Configuration with Redundancy

<i>Quantity</i>	<i>Order Number</i>	<i>Description</i>
1	E10000-4	Enterprise 10000 Server Base Package, Ultra Enterprise 10000 Base Cabinet, cage for 16 System Boards, Peripheral space with power sequencer, Solaris license for unlimited users, Licenses for AP and SSP software
4	3865A or 3851A	Power Cords
1	SOLMS-26EW9999	Solaris 2.6 HW 5/98 for Servers
1	SOLMS-070W999	Solaris 7 HW 8/99 for Servers (for the System Service processor)
2	2754A	System Service Processor
2	various	SSP Country Kit
2	2722A	Control Board, with rack mounted Ethernet Hub
4	3875A	AC Breaker and Filter assy
8	9685A	48 volt power supply
16	9671A	Fan tray
10	2761A	System Board
40	2580A	Processor Modules, 400-MHz with 8MB external Cache
4	2730A	Dual SBus I/O Board
1	1049A	Quad FastEthernet SBus Card (QFE)
5	7025A	Memory Board - unpopulated
20	7023A	1-Gbyte Memory expansion
1	9645AR4	UniPack tray with two split power cables
4	SG-DSK010C-9G	9.1 Gbyte 10000 RPM StorEdge UniPacks
4	902A	2-meter 68-pin external SCSI cables
4	1065A	SBus UltraSCSI host adapters
1	9620A	Optional 2nd AC power sequencer
2	3800A/3848A	Power Cord for E10000 internal I/O
Enterprise 10000 with fourty 400-MHz/8MB UltraSPARC Processors, 20-Gbyte of Memory and two mirrored boot devices		

Enterprise 10000 Configuration Overview

Enterprise 10000 Cabinet

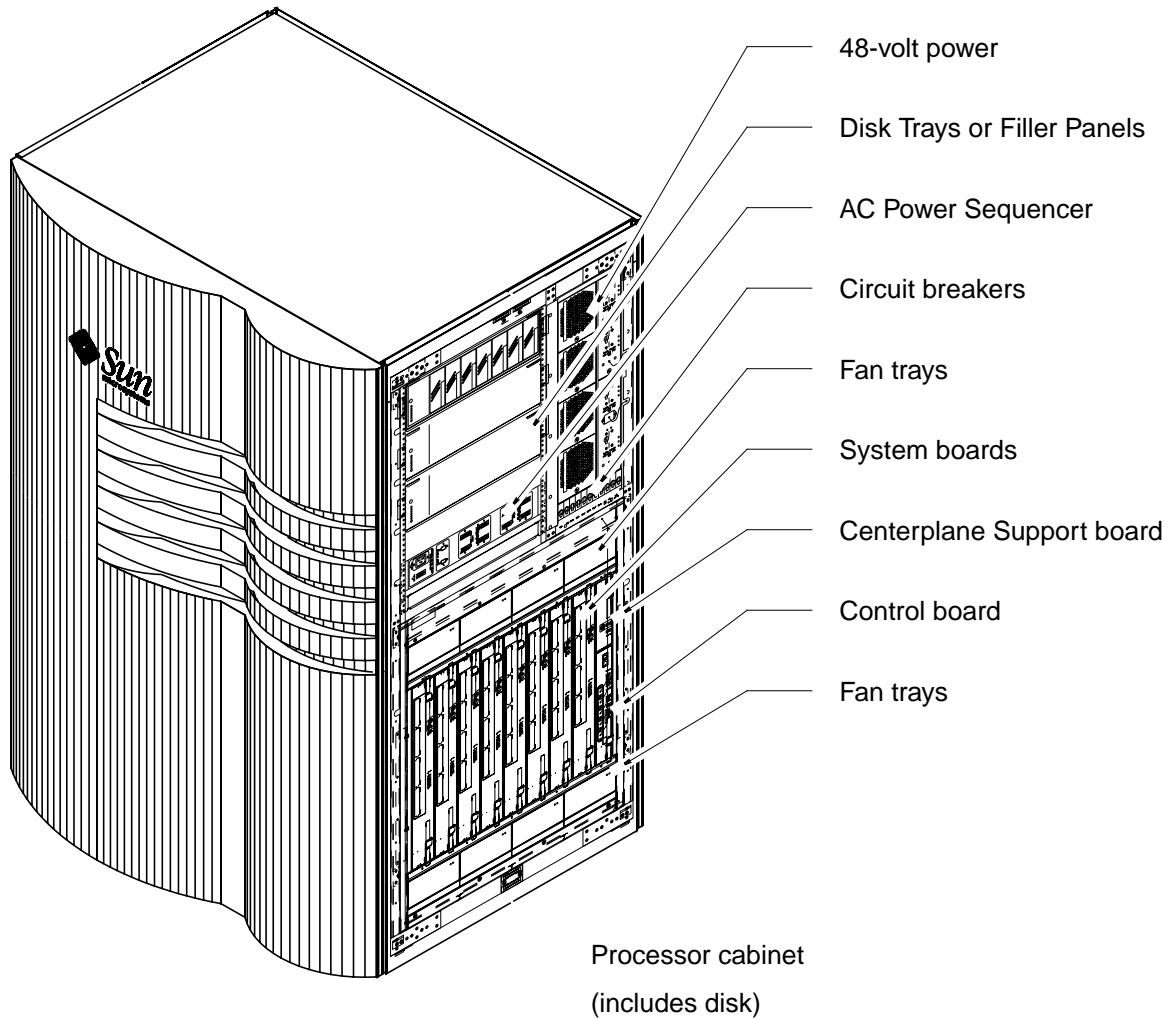

Enterprise 10000 Configuration Overview *(continued)*

System Board Assembly

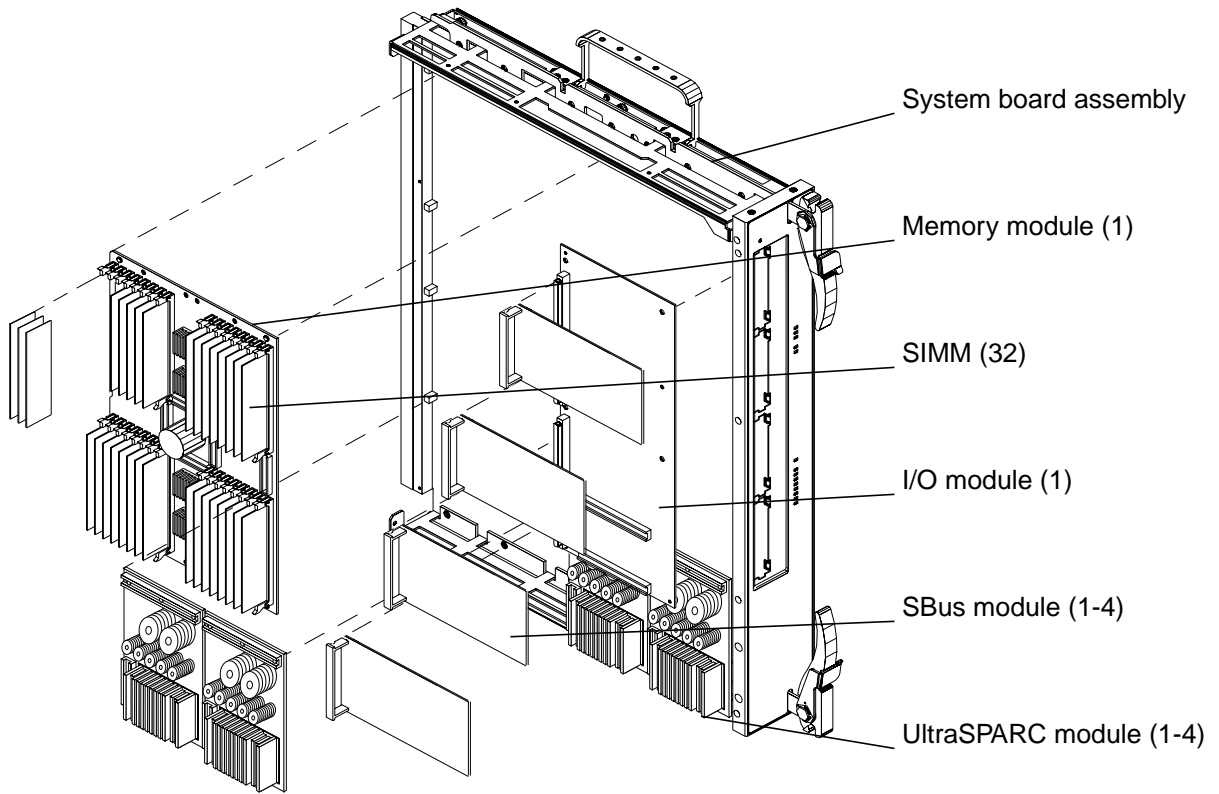

Power and Cooling Components

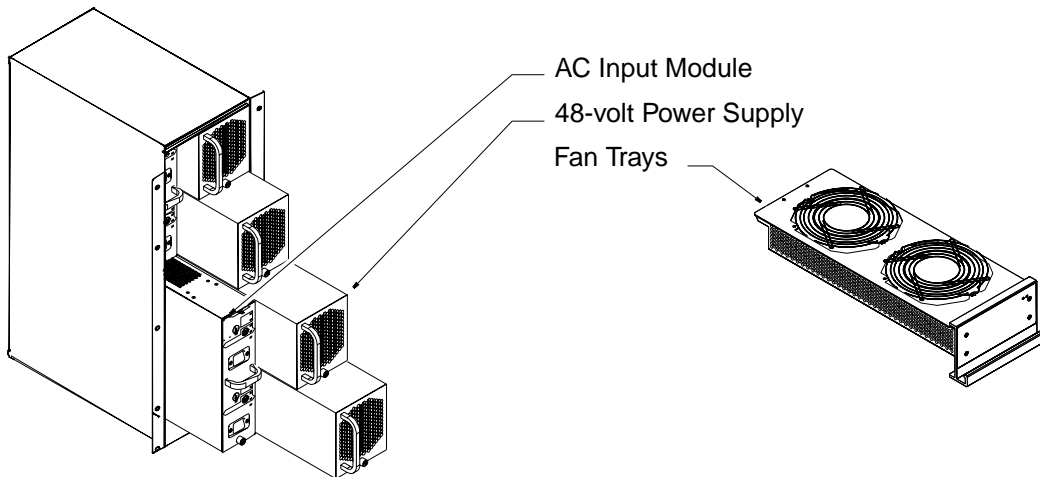

Enterprise 10000

Description	Order Number
Base Package	
Sun Enterprise 10000 base cabinet, cage for 16 System Boards, Peripheral space with power sequencer. Solaris license for unlimited users, Licenses for SSP software	E10000-4
Sun Enterprise 10000 Power Express System. Base cabinet includes: 8 power supplies (9685A), 4 AC Input Modules (3875A), and 16 fan trays (9671A) I	E10000-D
System Boards	
Must choose at least one	
E10000 System Board (without memory, processor modules or I/O board)	2761A
Power Express board for E10K. Includes one system board (2761A), 4 UltraSPARC Modules 400MHz-8-Mbyte (2580A), 2GB Memory (7023A) Memory Board (7025A), 1 dual SBus I/O board (2730A)	2861A
Capacity-On-Demand System Boards Package	
Optional	
Sun Enterprise 10000 Capacity- On-Demand system board package: 1 system board (2761A), 4 USII modules 400MHz-8Mbyte external cache (2580A), 2GB Memory (7023A), 1 Memory Board (7025A), 1 dual SBus I/O Board (2730A), Does NOT include any RTU CPU Licenses-Order Separately	2860A
Capacity-On-Demand Convert Licenses	
Order only if includes Capacity-On-Demand System Board(s)	
E10K Capacity-On-Demand conversion Order enough RTU CPU licenses for an installed E10000 system Order this only for E10K systems converting to Capacity-On-Demand	E10000-COD-C ONVERT
License to use CPU Modules beyond 20 with the E10000 Capacity-On-Demand System Board Package	
Enterprise 10000 RTU license for one 400MHz 8-MByte USII module. Order for additional CPU licenses beyond 20 CPUs licensed for E10000-C base cabinet or installed E10000 system	E10000-RTU-TI ER2
UltraSPARC Modules	
Must choose at least four	
336/333-MHZ UltraSPARC Module with 4-Mbyte of external cache.	2560A ¹
400-MHZ UltraSPARC Module with 8-Mbyte of external cache. OEM ready - 05/99	2580A ^{1,2}
Memory Board/Memory	
Must choose at least one Memory Board	
E1000 Memory Board - unpopulated	7025A ¹
Must choose at least two Memory Expansions per Memory Board	
256-Mbyte Memory Expansion (8 x 32MB memory modules) OEM ready - 05/96	7022A ^{1,2}
1-Gbyte Memory Expansion (8 x 128MB memory modules) OEM ready - 05/96	7023A ^{1,2}

Footnotes

1. Add "X" before the order number (e.g., XnnnA) to order as a standalone option for existing systems.
2. This product is OEM-Ready, please refer to the "Ordering Policies and Guidelines" section page 1-1.

Enterprise 10000 *(continued)*

Description	Order Number
I/O Board	
Must choose at least one	
E10000 dual SBus I/O daughter card. Optionally available to add four SBus slots to System Boards.	2730A ¹
E10000 PCI Module, Optionally available to add two PCI slots to a System Board -Factory installed option	2731A ¹

System Power Options

Choose one

E10000 power cord (14 ft) To be ordered for installs within North America (USA or Canada). Order quantity three for base system.	3865A ¹
E10000 power cord (International Version)	3851A ¹

Note: Order a quantity of three for a total of up to 8 System Boards.

System Service Processor

E10000 System Service Processor, (SSP). Ultra 5 workstation with one 360MHz CPU module, 128-Mbyte memory, 8.4-Gbyte internal disk, 32X CD-ROM, QFE PCI Card (1034A), and 19" color monitor	2754A ¹
E10000 System Service Processor, (SSP) Enterprise 250 server with one 400MHz CPU module, 256-Mbyte memory, 2-9.1Gbyte internal disks, 32X CD-ROM, 4mm DDS3 tape, QFE PCI card (1034A)	2755A ¹

Note: An additional copy of the OS should be ordered specifically for the SSP; order Solaris 7.

SSP 3.3 Supports 16 domains and Automated Dynamic Reconfiguration, to order SSP 3.3 choose one:

E10000 System Service Processor 3.3 Web Release. English. It support 16 domains, Automated DR, Dual-Power power source etc.	SSP9S-330-SAB 9
---	--------------------

Footnotes

1. Add "X" before the order number (e.g., XnnnA) to order as a standalone option for existing systems.
2. This product is OEM-Ready, please refer to the "Ordering Policies and Guidelines" section page I-1.

Enterprise 10000 (continued)

Description	Order Number
Country Kits for System Service Processor (Type 6 with Sun I/O)	
Choose one	
North America/universal/Canadian Type 6 Country Kits with Sun I/O for E10000	3508A
European Universal Type 6 Country Kits with Sun I/O for E10000	3530A
French Type 6 Country Kits with Sun I/O for E10000	3509A
German Type 6 Country Kits with Sun I/O for E10000	3510A
UK Type 6 Country Kits with Sun I/O for E10000	3514A

Software**Must appear on order, if Capacity-On-Demand system boards are ordered**

E10000 Capacity-On-Demand Software version 1.0 (web release and documentation included) NO RTU CPU licenses included E10000-SW-COD-1.0

Must appear on order (Choose one Solaris version for Domains)

Solaris 2.6 5/98 English Server Media Kit SOLMS-26EW9999¹
 Solaris 2.5.1 Hardware 11/97 US English Server Media Kit No Licenses Included SOLS-2.5.1NOV97
 Solaris 7 Standard, Latest Release English Server Media Kit SOLMS-070W9999⁵
 Solaris 8 Standard, Latest Release English-Only Media Kit SOLZS-080B9AY9

Select SSP software as required

E10000 System Service Processor 3.2 CD Release. English. SSP9S-320-SAM9
 E10000 System Service Processor 3.3 Web Release. English. It support 16 domains, Automated DR, Dual-Power power source etc. SSP9S-330-SAB9
 Solaris 7 8/99 English Server Media Kit SOLMS-07DW9999

Note: SSP 3.2 is included in Solaris 7 CD. Order SSP 3.2 separately only for Solaris 2.5.1 and Solaris 2.6

Alternate Pathing 2.3 (for E10000 users running Solaris 2.6 or Solaris 7)

E10000 Alternate Pathing 2.3 CD Release. English. It provides AP for Solaris 8 Operating Environment as well as Solaris 7 and 2.6. AP09S-230-SAM9

Note: AP 2.3 is also available at <http://www.sun.com/servers/sw>

Base Cabinet Options

Enterprise 10000 Control Board including Ethernet cable and rack mounted Ethernet Hub. Supports 5 to 1 and 4 to 1 modes on E10000	2722A ²
E10000 AC input module.	3875A ²
E10000 48 volt power supply.	9685A ²
E10000 fan tray.	9671A ²
Second Power Sequencer for 68-inch Enterprise System and Expansion Cabinet OEM ready - 05/98	9620A ^{2,5}
E10000 Power Control Module w/ cables to Control Boards	9681A ²
E10000 flat side panel, This is a no charge substitution for the styling panel.	9693A ²

Footnotes

1. AP 2.1 software comes bundled with Solaris 2.6 Hardware 5/98 and resides on the supplements CD.
2. Add "X" before the order number (e.g., XnnnA) to order as a standalone option for existing systems.
3. Remove X from order number (e.g., SG-ARY030A) for factory installation.
4. Two power cords are required per 72-inch StorEdge Expansion Rack.
5. This product is OEM-Ready, please refer to the "Ordering Policies and Guidelines" section page I-1.

Enterprise 10000 *(continued)*

Description	Order Number
I/O Expansion	
72-inch StorEdge Expansion Rack w/ 2 power sequencers and cables The StorEdge Expansion Rack is intended for a variety of Storage Products including the A1000/D1000, A3000, A5000, and tape products. The rack is 24" wide and 72" tall. This rack will include power sequencers and power cables.	SG-XARY030A ²
U.S./Canada power cord for 72" StorEdge expansion cabinet (NEMA L6-30P plug)	3858A ^{1,3}
International power cord for 72" StorEdge expansion cabinet (IEC 309, 32A, 250V plug)	3859A ^{1,3}

Footnotes

1. Add "X" before the order number (e.g., XnnnA) to order as a standalone option for existing systems.
2. Remove X from order number (e.g. SG-ARY030A) for factory installation.
3. Two power cords are required per 72-inch StorEdge Expansion Rack.

Enterprise 10000 Options

Description	Order Number
SBus controllers with DR support¹	
SBus Differential Fast/Wide Intelligent SCSI-2 Host Adapter (DWIS/S)	1062A ²
SBus Single-Ended Fast/Wide Intelligent SCSI-2 Host Adapter (SWIS/S)	1063A ²
SBus Ultra Differential F/W Intelligent SCSI Host Adapter.	1065A ²
Sun GigabitEthernet SBus Adapter 2.0	1140A ²
Quad FastEthernet 2.0 SBus Card (QFE) supports Sun Trunking 1.0 software	1049A ^{2,3}
SunFDDI 6.0 Single-Attach SBus Adapter (SAS) (SBus Card, Media, Documentation and Single-SBus License)	1142A ²
SunFDDI 6.0 Dual-Attach SBus Adapter (DAS) (SBus Card, Media, Documentation and Single-SBus License)	1143A ²
SunFastEthernet 10/100 SBus Adapter 2.0 SBus Card, Media, Documentation and Single-SBus License	1059A ²
SunFastEthernet 10/100 SBus Adapter 2.0 SBus Card, and Solaris 1.x Driver	
SunSwift 100BaseT fast/wide SCSI SBus Adapter	1018A ²
FC-AL 100MB/sec Dual Channel SBus host adapter w/1 GBIC module	6730A ^{2,4}
SBus controllers with no DR support	
SunATM SBus Adapter 4.0 Update 1 SBus Card, Documentation, and Single-SBus License	1147A ²
SunATM-155/MFiber SBus Adapter 4.0 - Factory Install Option	
SunATM SBus Adapter 4.0 Update 1 SBus Card, Documentation, and Single-SBus License	1149A ²
SunATM-622/MFiber SBus Adapter 4.0 - Factory Install Option	
SunATM SBus Adapter 4.0 Update 1 SBus Card, Documentation, and Single-SBus License	1148A ²
SunATM-155/UTP5 SBus Adapter 4.0 - Factory Install Option	
Serial Parallel Controller (SPC/S) for Solaris 2.x (S-Bus card, cable and external eight-port I/O box with RS-232 connectors, and Docs) Factory Installed Option	1146A ²
High-Speed Serial Interface/SBus (HSI/S) for Solaris 2.x (SBus Card, cable with four RS-449 connectors, Media, Documentation and Single S-Bus license) Factory Installed Option	1145A ²
Token Ring Interface/SBus (TRI/S) for Solaris 8 and earlier releases. (SBus Card, Media, Documentation and single S-bus License) Factory Installed Option	2144A ²
PCI controller with DR support¹	
Sun GigabitEthernet PCI Adapter 2.0	1141A ^{1,2}
Interface Card	
HIPPI/P 1.1 Board High Perf. Interface Board	1071A

Footnotes

1. "DR" is the ability to Dynamically Reconfigure a System Board. Drivers for SBus Boards have to be "DR safe".
2. Add "X" before the order number (e.g., XnnnA) to order as a standalone option for existing systems.
3. Sun Trunking software not supported.
4. If configured in the E10000 system cabinet, P/N should be 6730AR4.

Enterprise 10000 Options *(continued)*

Description	Order Number
Internal Storage Options	
E10000 UniPack tray, holds four devices, includes two power cords.	9645AR4 ¹
9.1-GBYTE 10k RPM StorEdge UniPack	SG-DSK010C-9G
Configurable w/ servers in factory: 36-Gbyte (4 x 9.1-Gbyte 10K RPM disks) Sun StorEdge D1000 for rack mounting in the StorEdge or Enterprise Expansion Racks w/1 Interface Card, 2 Power supplies, 2 fantrays (4fans), 4 Differential UltraSCSI to host ports	SG-ARY147A-36GR4
Server-Rack Mount. 72-GBYTE D1000 (4 x 18GB 10,000 RPM disks), w/1 Interface Card, 2 Power supplies, 2 fantrays, factory configured in a system cabinet.	SG-ARY154A-72GR4
2-meter 68-pin External SCSI Cable OEM ready - 05/96	902A ²

Other SBus and Mass Storage Options

- *Additional SBus and Mass Storage Options can be found in the Options section of the Pricebook.*
-

General Notes

- *"DR" is the ability to Dynamically Reconfigure a System Board. Drivers for SBus Boards have to be "DR safe".*
 - *Sun Trunking software not supported.*
 - *If configured in the E10000 system cabinet, P/N should be 6730AR4.*
-

Footnotes

1. *Add "X" before the order number (e.g., XnnnA) to order as a standalone option for existing systems.*
2. *This product is OEM-Ready, please refer to the "Ordering Policies and Guidelines" section page I-1.*

Enterprise 10000 Configure to Order Flow Chart

Each step represents a required/recommended line item on a Sales Order

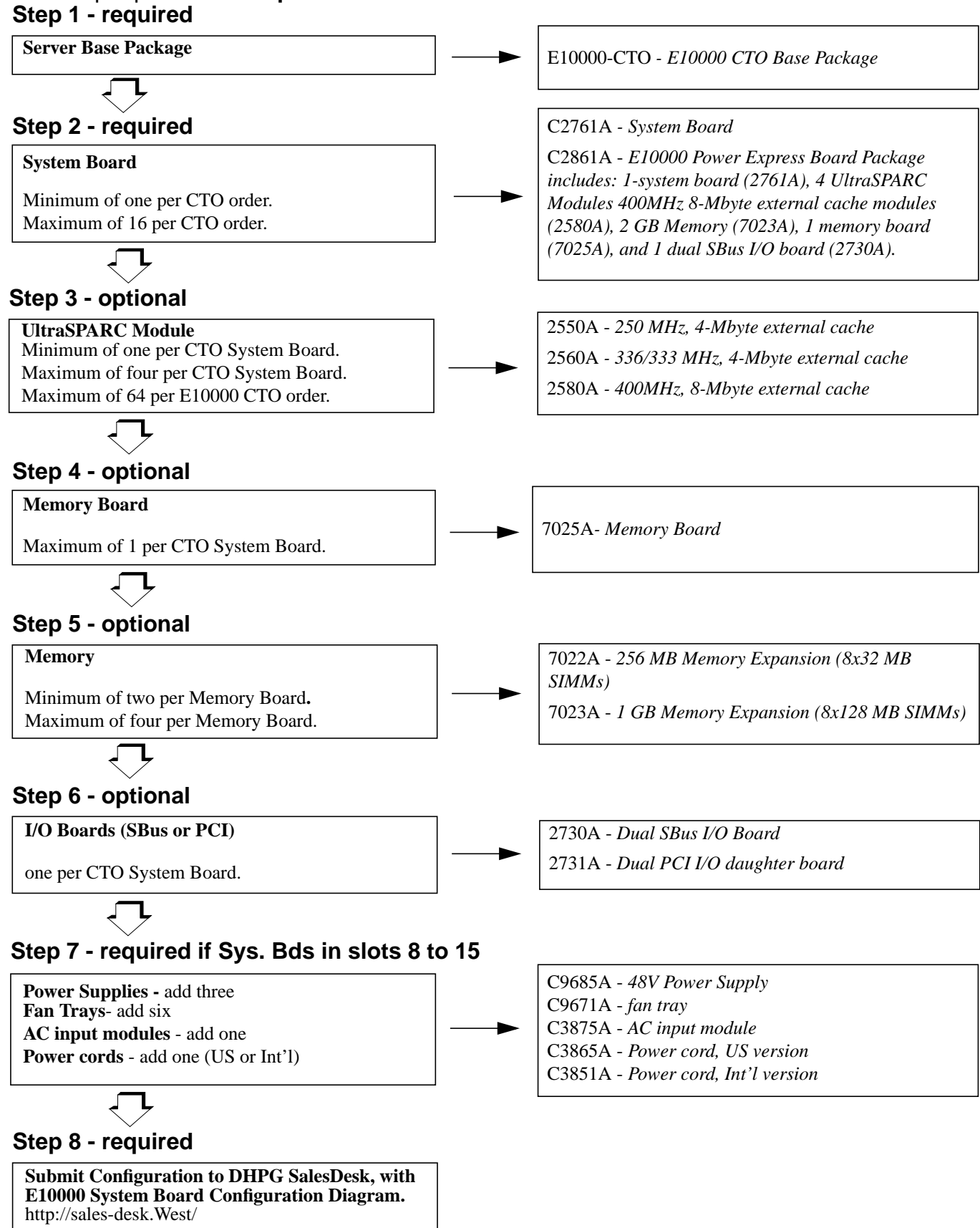

Enterprise 10000 Configure to Order Guidelines

General Comments

- Configure-to-Order allows Enterprise 10000 systems in the field to be expanded using pre-tested System Boards that have been configured with processors, memory and SBus or PCI I/O boards.
- SBus or PCI adapters are not supported with this process.
- This is an alternative to ordering these components separately, as X options, and assembling and testing at the customer's site.
- There is provision to order the power and cooling expansion if, following the expansion, there will be System Boards in slots 8 to 15.

System Boards

- The configuration rules for processors and memory are as for a new system order.
- Up to 16 System Boards can be ordered on one CTO order.

Power and Cooling expansion

- Rules are the same as for a new system order. The advantage of ordering the extra power supplies, fans and line cord as part of the CTO order is that shipment will occur at the same time as the System Board(s).

DHPG Sales Desk

- The function of this organization is to check each Enterprise 10000 configuration for legitimacy and for satisfaction of customer's requirements (<http://sales-desk.West/>)
- Each Enterprise 10000 order must be accompanied by a configuration diagram that adds information missing from the order. For example: number of Domains, how the disk devices are connected to SBus boards, etc.

Enterprise 10000 Configure to Order Options

Description	Order Number
Sun Enterprise 10000 configure- to-order factory options	E10000-CTO
E10000 configure-to-order System Board (without memory, processor modules or I/O board)	C2761A
Power express board for E10K. Includes one system board(2761A), 4 UltraSPARC modules 400MHz-8-Mbyte (2580A), 2GB Memory(7023A) Memory Board(7025A), 1 dual SBus I/O board(2730A)	C2861A
E10000 configure-to-order 48 volt power supply.	C9685A
E10000 configure-to-order AC input module.	C3875A
E10000 configure-to-order fan tray	C9671A
E10000 configure-to order pwr cord (14 ft) for installs within North America (USA or Canada). Order quantity three for base system.	C3865A
E10000 configure-to-order pwr cord (International Version)	C3851A

Footnote

1. For configuration rules and pricing information on UltraSPARC modules, Memory Board/Memory, and I/O Boards, please refer to E10000 section.

Enterprise 10000 Capacity-On-Demand Ordering Flow Chart

Each step represents a **required/recommended** line item on a Sales Order

Step 1 - required

Server Base Package



E10000-C - Enterprise 10000 Capacity-On-Demand Base Package includes: 8 power supplies (9685A), 4 AC input modules (3875A), 16 fan trays (9671A), and includes a RTU license to use 8 UltraSPARC 400MHz 8-Mbyte Modules.



Step 2 - required

Capacity-On-Demand System Board Package
Minimum of 5 per Capacity-On-Demand System.
Maximum of 16 per Capacity-On-Demand System.



2860A - Capacity-On-Demand System Board Package includes: 1-system board (2761A), 4 UltraSPARC Modules 400MHz 8-Mbyte external cache (2580A), 2 GB Memory (7023A), 1 memory board (7025A), and 1 dual SBus I/O board (2730A).



Step 3 - optional

License for additional RTU CPUs for E10000-C only



E10000-RTU-TIER1 - One RTU License for One 400MHz 8-Mbyte UltraSPARC Module. Order for additional RTU CPU licenses for E10000-C base package up to 20 RTU licenses (note: E10000-C includes 8 RTU CPU Licenses)



Step 4 - optional

Control Board
Minimum of one per System.
Two for redundancy.



2722A - Control Board, with Ethernet Hub



Step 5 - required

System Service Processor (SSP)
Minimum of one per System.
Two for redundancy.



Select One:
2754A- System Service Processor (Ultra 5)
2755A- System Service Processor (E250)
(See SSP note)



Step 6 - required

SSP Country Kits
Order one per SSP.



Choose From
3508A- North american/Universal Type 6 country kit
3530A- European/Universal Type 6 country kit
3509A- French Type 6 country kit
3510A- German Type 6 country kit
3514A- United Kingdom Type 6 country kit



Enterprise 10000 Capacity-On-Demand Ordering Flow Chart

(continued)

Each step represents a **required/recommended** line item on a Sales Order

Step 7- required

Software
Order must include 1 Version of Solaris to be used in the domains, SSP 3.1.1 Software (part of the Solaris 7 media kit), AP software, E10000 Capacity-On-Demand Software, and the Solaris software specifically to reside on the SSP.
note: ONLY SSP software supported with E10000 Capacity-On-Demand is SSP 3.1.1



Capacity-On-Demand Software:
E10000-SW-COD-1.0 - *E10000 Capacity-On-Demand software v1.0 for web release and all documentation*

Domain software:
SOLMS-26EW9999 - *Solaris 2.6 Server edition*
SOLMS-070W9999 - *Solaris 7 Server edition*
SOLS-2.5.1NOV97 - *Solaris 2.5.1 Server edition*

SSP software:
SSP9S-320-SAM9 - *System Service Processor software version 3.2 (CD release)*
SOLMS-070W9999 - *Solaris 7 Server edition (SSP 3.2 is located on the supplemental disk)*
SSP9S-330-SAB9 - *SSP 3.3 (Web release)*



Step 8- optional

Internal Disk Storage Options
Maximum of 2 StorEdge D1000's in E10000 system cabinet. Maximum of 16 UniPack disks and 4 UniPack trays in E10000 system cabinet.



Choose from:

SG-ARY147A-36GR4 - *36GB StorEdge D1000*
SG-ARY136A-72GR4 - *72GB StorEdge D1000*
SG-DSK010A-9G - *9.1-Gbyte StorEdge UniPack*
9645AR4 - *StorEdge UniPack tray*
902A- *2-meter 68-pin SCSI cable*



Step 9 - optional

Power Control Module/2nd AC sequencer
Up to five power control modules per system.
One second AC power sequencer.



9681A - *Power Control Module w/cable*
9620A - *Optional 2nd AC power sequencer*



Enterprise 10000 Capacity-On-Demand Ordering Flow Chart

(continued)

Each step represents a **required/recommended** line item on a Sales Order

Step 10 - optional

Interfaces and Host Adapters

These options may be required to support configured mass storage and tape devices (optional).



Choose from:

- 1061A - SBus ATM-155/UTP Host Adapter
- 1062A - SBus DWIS/S Host Adapter
- 1063A - SBus SWIS/S Host Adapter
- 1065A - SBus Ultra DWIS/S Host Adapter (Req for Internal Storage - 1 per D1000 Tray)
- 1071A - HPPI PCI Network Interface Card
- 1140A - SBus Gigabit Ethernet 2.0 Adapter
- 1141A - PCI Gigabit Ethernet 2.0 Adapter
- 1073A - SBus Cluster interconnect card (SCI)
- 1049A - Quad FastEthernet SBus Card (QFE)
- 1142A - SBus SAS FDDI 6.0 Adapter
- 1143A - SBus DAS FDDI 6.0 Adapter
- 1059A - SBus Fast Ethernet Adapter 2.0
- 1146A - SBus Serial Parallel Controller (SPC/S)
- 1018A - SBus SunSwift 100BaseT Adapter
- X1145A - SBus High-Speed Serial Interface (HSI/S)
- 1060A - SBus SunATM-155/MFiber Adapter 2.0
- 1064A - SBus SunATM-622/MFiber Adapter
- 2144A - Token Ring Interface/SBus (TRI/S) Card
- 6730A - FC-AL SBus Host Adapter



Step 11 - required

Power Cord for System

Minimum of four per Cabinet.



Choose one:

- 3865A - Power Cord, U.S. Version
- 3851A - Power Cord, International Version



Step 12 - required

Power Cord for AC sequencers in System Cabinet

One required if RSM trays in System Cabinet.



Choose one:

- 3800A - Power Cord, U.S. Version
- 3848A - Power Cord, International Version



Step 13 - required

Submit Configuration to DHPG SalesDesk, with E10000 Configuration Diagram.
<http://sales-desk.West/>

Enterprise 10000 Capacity-On-Demand System Configuration Guidelines

General Comments

- All items which are supported with the standard E10000 configuration are also supported with E10000 Capacity-On-Demand base package, refer to the E10000 order note section for configuration rules.

Capacity-On-Demand Server Base Package Information

- Enterprise 10000 Capacity-On-Demand Base Package includes: system chassis, 8 power supplies (9685A), 4 AC input modules (3875A), 16 fan trays (9671A), and includes RTU license to use 8 UltraSPARC Modules 400MHz 8-Mbyte modules and Licenses for AP and SSP software.

Capacity-On-Demand System Board Package

- Capacity-On-Demand System Board Package includes: 1 system board (2761A), 4 UltraSPARC Modules 400MHz 8-Mbyte external cache (2580A), 2 GB Memory (7023A), 1 memory board (7025A), and 1 dual SBus I/O board (2730A).
- Minimum of five per system. Maximum number of System Boards is 16.
- Capacity-On-Demand System Board Package does not include any RTU CPU license, must be ordered separately.

CPU Licensing for E10000 Capacity-On-Demand base package ONLY

- The E10000 Capacity-On-Demand Base Package only includes a license to utilize 8 UltraSPARC Modules 400MHz 8-Mbyte.
- Order License for additional RTU CPUs for E10000-C only via E10000-RTU-TIER1 P/N, up to 20 CPU RTU Licenses.

CPU Licensing for E10000 Capacity-On-Demand Configure-To-Order System Boards

- Order for additional CPU licenses beyond 20 RTU licenses for E10000-C base package via E10000-RTU-TIER2.

Enterprise 10000 Capacity-On-Demand Sample Configurations

Enterprise 10000 Configuration		
Quantity	Order Number	Description
1	E10000-C	Enterprise 10000 Capacity-On-Demand Base Package includes: system chassis, 8 power supplies (9685A), 4 AC input modules (3875A), 16 fan trays (9617A), and includes a RTU license to use 8 UltraSPARC 400MHz 8-Mbyte Modules
5	2860A	COD System Board Package includes: 1 system board (2761A), 4 UltraSPARC Modules 400MHz 8-Mbyte external caches(2580A), 2 GB Memory (7023A), 1 memory board (7025A), and 1 dual SBus I/O board (2730A).
4	3865A or 3851A	Power Cords
1	SOLMS-26EW9999	Solaris 2.6 HW 5/98 for Servers
1	SOLMS-070WD999	Solaris 7 media kit which includes E10000 System Service Processor 3.1.1 software
1	E10000-SW-COD-1.0	Sun Enterprise 10000 Capacity-On-Demand software
1	2754A	E10000 System Service Processor (Ultra 5 with 19" monitor)
1	2722A	E10000 Control Board
1	various	SSP Country Kit
1	1049A	Quad FastEthernet SBus Card (QFE)
1	SG-ARY147A-36GR4	36GB StorEdge D1000
1	1065A	SBus Ultra Differential F/W Intelligent SCSI Host Adapter
1	3800A/3848A	Power Cord for E10000 internal I/O
Enterprise 10000 with sixteen 400-MHz/8MB UltraSPARC Processors, 2-Gbyte of Memory and 36-Gbyte of internal disk storage		

Enterprise 10000 Capacity-On-Demand Information

Description	Order Number
Capacity-On-Demand Base Package	
Sun Enterprise 10000 Capacity- On-Demand base cabinet includes: 8 power supplies (9685A), 1 pwr seqr., 4 AC Input Modules (3875A), 16 fan trays (9671A) and a RTU license to use 8 UltraSPARCII 400MHz 8-Mbyte Modules I	E10000-C
Capacity-On-Demand Systems Board Package	
Must choose at least five	
Sun Enterprise 10000 Capacity- On-Demand system board package: 1 system board (2761A), 4 USII modules 400MHz-8Mbyte external cache (2580A), 2GB Memory (7023A), 1 Memory Board (7025A), 1 dual SBus I/O Board (2730A), Does NOT include any RTU CPU Licenses-Order Separately	2860A
Capacity-On-Demand Software	
E10000 Capacity-On-Demand Software version 1.0 (web release and documentation included) NO RTU CPU licenses included	E10000-SW-COD-1.0
Additional License to use CPU Modules for E10000-C ONLY (up to 20 RTU CPU licenses)	
Enterprise 10000 RTU license for one 400MHz 8-MByte USII module. For an additional CPU license to the E10000-C system cabinet, up to 20 CPU RTU licenses	E10000-RTU-TIER1
Additional License to use CPU Modules beyond 20 RTU CPU Licenses	
Enterprise 10000 RTU license for one 400MHz 8-MByte USII module. Order for additional CPU licenses beyond 20 CPUs licensed for E10000-C base cabinet or installed E10000 system	E10000-RTU-TIER2

Enterprise 10000 Capacity-On-Demand CTO Flow Chart

Each step represents a **required/recommended** line item on a Sales Order

Step 1 - required

Server Base Package



E10000-CTO - *E10000 CTO Base Package*



Step 2 - required

Capacity-On-Demand System Board Package
Minimum of one per CTO order.
Maximum of 16 per CTO order.



C2860A - *Capacity-On-Demand System Board Package includes: 1-system board (2761A), 4 UltraSPARC Modules 400MHz 8-Mbyte external cache (2580A), 2 GB Memory (7023A), 1 memory board (7025A), and 1 dual SBus I/O board (2730A).*



Step 3 - optional

License for additional RTU CPUs beyond 20 CPU RTU Licenses



E10000-RTU-TIER2 - *One RTU License for One 400MHz 8-Mbyte UltraSPARC Module. Order for additional RTU CPU licenses beyond 20 CPU RTUs with the E10000-C base package.*



Step 4 - required

Submit Configuration to DHPG SalesDesk, with E10000 Configuration Diagram.
<http://sales-desk.West/>

Enterprise 10000 Capacity-On-Demand CTO Guidelines

General Comments

- Configure-to-Order allows Enterprise 10000 Capacity-On-Demand systems in the field to be expanded using pre-tested System Boards package which includes: 1 system board (2761A), 4 UltraSPARC Modules 400MHz 8-Mbyte external cache (2580A), 2 GB Memory (7023A), 1 memory board (7025A), and 1 dual SBus I/O board (2730A).
- SBus or PCI adapters are not supported with this process.
- This is an alternative to ordering these components separately, as X options, and assembling and testing at the customer's site.

Capacity-On-Demand System Board Package

- Capacity-On-Demand System Board Package includes: 1 system board (2761A), 4 UltraSPARC Modules 400MHz 8-Mbyte external cache (2580A), 2 GB Memory (7023A), 1 memory board (7025A), and 1 dual SBus I/O board (2730A).
- Capacity-On-Demand CTO system board orders can be installed without any RTU CPU licenses and do not include any RTU-CPU licenses.

CPU Licensing for Capacity-On-Demand Configure-to-Order Boards

- Order E10000-RTU-TIER2 for additional CPU licenses beyond 20 RTU CPU licenses for E10000-C base package.
- Order E10000-RTU-TIER1 for additional CPU licenses from 9-20 RTU CPUs for E10000-C base package (note: E10000-C base package includes 8 RTU CPU licenses)

DHPG Sales Desk

- The function of this organization is to check each Enterprise 10000 configuration for legitimacy and for satisfaction of customer's requirements (<http://sales-desk/West/>)
- Each Enterprise 10000 order must be accompanied by a configuration diagram that adds information missing from the order. For example: number of Domains, how the disk devices are connected to SBus boards, etc.

Enterprise 10000 Configure to Order CTO Options

Description	Order Number
Capacity-On-Demand Systems Board Package	
Sun Enterprise 10000 configure- to-order factory options	E10000-CTO
Sun Enterprise 10000 COD capacity-, on-demand system board package: 1 system board (2761A), 4 USII modules 400MHz-8Mbyte external cache (2580A), 2GB Memory (7023A), 1 Memory Board (7025A), 1 dual SBus I/O Board (2730A), Does NOT include any RTU CPU Licenses-Order Separately	C2860A
Additional License to use CPU Modules beyond 20 RTU CPU Licenses	
Enterprise 10000 RTU license for one 400MHz 8-MByte USII module. Order for additional CPU licenses beyond 20 CPUs licensed for E10000-C base cabinet or installed E10000 system	E10000-RTU-TIER2
Enterprise 10000 RTU license for one 400MHz 8-MByte USII module. For an additional CPU license to the E10000-C system cabinet, up to 20 CPU RTU licenses	E10000-RTU-TIER1

Enterprise 10000 non-Capacity-On-Demand TO Capacity-On-Demand Conversion Flow Chart

Each step represents a **required/recommended** line item on a Sales Order

Step 1 - required

Server Base Package

E10000-CTO - *E10000 CTO Base Package*



Step 2 - required

Capacity-On-Demand System Board Package

Minimum of one per CTO order.
Maximum of 16 per CTO order.

C2780A - *Capacity-On-Demand System Board Package includes: 1-system board (2761A), 4 UltraSPARC Modules 400MHz 8-Mbyte external cache (2580A), 2 GB Memory (7023A), 1 memory board (7025A), and 1 dual SBus I/O board (2730A).*



Step 3 - required

License for installed RTU CPUs

E10000-COD-CONVERT - *Order quantity must include the number of CPUs installed in the E10000 system (quantity = number of CPU's installed)*



Step 4- required

Software

E10000-SW-COD-1.0 - *E10000 Capacity-On-Demand software v1.0 for web release and all documentation*



Step 5- optional

License for additional RTU CPUs beyond 20 CPU RTU Licenses

E10000-RTU-TIER2 - *One RTU License for One 400MHz 8-Mbyte UltraSPARC Module. Order for additional RTU CPU licenses beyond 20 CPU RTUs with the E10000-C base package.*



Step 6- required

Submit Configuration to DHPG SalesDesk, with E10000 Configuration Diagram.
<http://sales-desk.West/>

Enterprise 10000 non-Capacity-On-Demand TO Capacity-On-Demand Conversion Guidelines

General Comments

- Customer agrees to install Capacity-On-Demand software.
- Customer must agree to upgrade to SSP software version 3.1.1 or above.
- Customer must have at least 20 400MHz CPU modules currently installed.

Capacity-On-Demand System Board Package

- Capacity-On-Demand System Board Package includes: 1 system board (2761A), 4 UltraSPARC Modules 400MHZ 8-Mbyte external cache (2580A), 2 GB Memory (7023A), 1 memory board (7025A), and 1 dual SBus I/O board (2730A).
- Capacity-On-Demand CTO system board orders can be installed without any RTU CPU licenses and do not include any RTU-CPU licenses.

CPU Licensing for Capacity-On-Demand Configure-to-Order Boards

- Order E10000-COD-CONVERT for the amount of 400MHz CPUs installed within E10000-C base package.
- Order E10000-RTU-TIER2 for additional CPU licenses beyond 20 RTU CPU licenses for E10000-C base package.

DHPG Sales Desk

- The function of this organization is to check each Enterprise 10000 configuration for legitimacy and for satisfaction of customer's requirements (<http://sales-desk/West/>)
- Each Enterprise 10000 order must be accompanied by a configuration diagram that adds information missing from the order. For example: number of Domains, how the disk devices are connected to SBus boards, etc.