



**Hitachi Freedom Storage™  
Lightning 9900™ V Series**

**LUN Manager User's Guide**



© 2002 Hitachi Data Systems Corporation, ALL RIGHTS RESERVED

**Notice:** No part of this publication may be reproduced or transmitted in any form or by any means, electronic or mechanical, including photocopying and recording, or stored in a database or retrieval system for any purpose without the express written permission of Hitachi Data Systems Corporation.

Hitachi Data Systems reserves the right to make changes to this document at any time without notice and assumes no responsibility for its use. Hitachi Data Systems products and services can only be ordered under the terms and conditions of Hitachi Data Systems' applicable agreements. All of the features described in this document may not be currently available. Refer to the most recent product announcement or contact your local Hitachi Data Systems sales office for information on feature and product availability.

This document contains the most current information available at the time of publication. When new and/or revised information becomes available, this entire document will be updated and distributed to all registered users.

## Trademarks

Hitachi Data Systems is a registered trademark and service mark of Hitachi, Ltd. The Hitachi Data Systems design mark is a trademark and service mark of Hitachi, Ltd.

Hi-Track is a registered service mark of Hitachi Data Systems Corporation. Graph-Track, Freedom Storage, Lightning 9900V are trademarks of Hitachi Data Systems Corporation.

VMS is a registered trademark of Compaq Computer Corporation. Tru64 is a trademark of Compaq Computer Corporation.

Emulex is a registered trademark of Emulex Corporation. Lightpulse is a trademark of Emulex Corporation.

HP-UX is a registered trademark of Hewlett-Packard Company.

S/390, S/380, AIX, and FICON, DYNIX/ptx and ESCON are registered trademarks of International Business Machines Corporation.

JNI is a registered trademark of Jaycor Systems Inc.

Internet Explorer, Windows 95, Windows 98, Windows ME, Windows NT, Windows XP, and Windows 2000 are trademarks or registered trademarks of Microsoft Corporation.

NetWare is a registered trademark of Novell, Inc.

IRIX is a registered trademark of Silicon Graphics, Inc.

Solaris, Java, Java Virtual Machine (JVM) and Java Runtime Environment (JRE) are trademarks or registered trademarks of Sun Microsystems, Inc.

All other brand or product names are or may be registered trademarks, trademarks or service marks of and are used to identify products or services of their respective owners.

## Notice of Export Controls

Export of technical data contained in this document may require an export license from the United States government and/or the government of Japan. Contact the Hitachi Data Systems Legal Department for any export compliance questions.

## Document Revision Level

| Revision     | Date       | Description         |
|--------------|------------|---------------------|
| MK-92RD105-P | April 2002 | Preliminary Release |
| MK-92RD105-0 | April 2002 | Initial Release     |

## Source Documents for This Revision

RSD-R450LM-0a (February, 2002)

RSD-R450LM-1 (March, 2002)

RSD-R450LM-2 (March, 2002)

RSD-R450LM-3 (April, 2002)

RSD- R105\_1a (April, 2002)

## Referenced Documents

Hitachi Lightning 9900V documentation referenced in this document:

- *Hitachi Freedom Storage™ Lightning 9900™ V Series User and Reference Guide* (MK-92RD100)
- *Hitachi Freedom Storage™ Lightning 9900™ V Series Remote Console - Storage Navigator User's Guide* (MK-92RD101)



## Preface

This *Hitachi Freedom Storage™ Lightning 9900™ V Series LUN Manager/LUN Security User's Guide* provides instructions for using the LUN Manager option on the 9900V Remote Console, using the web client Java™ applet program for the 9900V subsystem.

This user's guide assumes that:

- The user has a background in data processing and understands direct-access storage device (DASD) subsystems and their basic functions,
- The user is familiar with the Hitachi 9900V array subsystem, and the user is familiar with the Windows NT® or Windows® 2000 operating systems.

For further information on the 9900V Remote Console and Java™ applet, please refer to the *Hitachi Freedom Storage™ Lightning 9900™ V Series Remote Console - Storage Navigator User's Guide* (MK-92RD100), or contact your Hitachi Data Systems account team.

For further information on the 9900V subsystem, please refer to the *Hitachi Freedom Storage™ Lightning 9900™ V Series User and Reference Guide* (MK-92RD100), or contact your Hitachi Data Systems account team.

**Note:** The term "9900V" refers to the entire Lightning 9900™ V Series subsystem family, unless otherwise noted. The use of the Lightning 9900™ V Series Remote Console, the web client Java™ applet and any other optional functions is governed by the terms of the applicable license and other agreement(s) with Hitachi Data Systems.

**Note:** This product includes software developed by the Apache Group for use in the Apache HTTP server project (<http://www.apache.org/>)

### Microcode Level

This document revision applies to 9900V microcode versions 21-01-XX and higher.

### COMMENTS

Please send us your comments on this document: [doc.comments@hds.com](mailto:doc.comments@hds.com).

Make sure to include the document title, number, and revision.  
Please refer to specific page(s) and paragraph(s) whenever possible.  
(All comments become the property of Hitachi Data Systems Corporation.)

**Thank you!**





# Contents

|                  |                                                                                |           |
|------------------|--------------------------------------------------------------------------------|-----------|
| <b>Chapter 1</b> | <b>Overview of LUN Manager and LUN Security</b> .....                          | <b>1</b>  |
| 1.1              | Overview of LUN Manager .....                                                  | 1         |
| 1.2              | Overview of LUN Security .....                                                 | 2         |
| <b>Chapter 2</b> | <b>Preparing To Use LUN Manager</b> .....                                      | <b>5</b>  |
| 2.1              | Set Up the 9900V Subsystem and Remote Console PC(s) .....                      | 5         |
| 2.2              | Launch LUN Manager .....                                                       | 6         |
| 2.3              | Changing to Modify Mode .....                                                  | 7         |
| <b>Chapter 3</b> | <b>The LUN Manager Panels</b> .....                                            | <b>9</b>  |
| 3.1              | LUN Manager/Port Panel, LUN Manager Tab .....                                  | 9         |
| 3.2              | LUN Manager/Port Panel, Port Tab .....                                         | 14        |
| <b>Chapter 4</b> | <b>LUN Manager Operations</b> .....                                            | <b>19</b> |
| 4.1              | Overview of Logical Volume and LU Path Configuration.....                      | 19        |
| 4.2              | Defining LU Paths .....                                                        | 21        |
| 4.2.1            | Finding the Worldwide Names (WWNs) of the Host Bus Adapters .....              | 21        |
| 4.2.1.1          | Finding the WWN for Windows NT® or Windows® 2000.....                          | 22        |
| 4.2.1.2          | Finding the WWN for Sun Solaris™.....                                          | 24        |
| 4.2.1.3          | Finding the WWN for AIX®, SGI IRIX®, or Sequent® .....                         | 24        |
| 4.2.1.4          | Finding the WWN for HP-UX® .....                                               | 25        |
| 4.2.2            | Creating Host Groups .....                                                     | 27        |
| 4.2.3            | Registering Hosts in Host Groups.....                                          | 31        |
| 4.2.4            | Associating Host Groups to Logical Volumes .....                               | 33        |
| 4.3              | Changing the LU Path Settings.....                                             | 34        |
| 4.3.1            | Deleting LU Paths.....                                                         | 34        |
| 4.3.2            | Changing WWNs and Names of Host Bus Adapters.....                              | 36        |
| 4.3.3            | Deleting WWNs .....                                                            | 37        |
| 4.3.4            | Changing the Name and the Host Mode of a Host Group.....                       | 38        |
| 4.3.5            | Deleting Host Groups.....                                                      | 40        |
| 4.3.6            | Defining Alternate Paths .....                                                 | 41        |
| 4.4              | Using LUN Security.....                                                        | 43        |
| 4.4.1            | Applying LUN Security .....                                                    | 43        |
| 4.4.2            | Removing LUN Security .....                                                    | 45        |
| 4.5              | Configuring the Disk Subsystem for Using Command Control Interface (CCI) ..... | 47        |
| 4.5.1            | Overview of Command Control Interface .....                                    | 47        |
| 4.5.2            | Specifying Logical Devices as Command Devices .....                            | 48        |
| 4.5.3            | Deleting a Command Device .....                                                | 50        |
| 4.5.4            | Enabling Command Device Security .....                                         | 52        |
| 4.5.5            | Removing Command Device Security .....                                         | 54        |
| 4.6              | Configuring Fibre-Channel Ports.....                                           | 56        |
| 4.6.1            | Setting Host Speed for Fibre-Channel Ports.....                                | 56        |
| 4.6.2            | Addressing Fibre-Channel Ports .....                                           | 58        |
| 4.6.3            | Setting the Fibre-Channel Topology .....                                       | 60        |
| 4.6.4            | Changing the Fibre PCB Mode Between Standard and High-speed Mode .....         | 63        |

|                                                    |                                                                 |           |
|----------------------------------------------------|-----------------------------------------------------------------|-----------|
| <b>Chapter 5</b>                                   | <b>Troubleshooting .....</b>                                    | <b>67</b> |
| 5.1                                                | Troubleshooting .....                                           | 67        |
| 5.2                                                | Calling the Hitachi Data Systems Technical Support Center ..... | 69        |
| <b>Glossary, Acronyms, and Abbreviations .....</b> |                                                                 | <b>71</b> |

# List of Figures

|             |                                                                                  |    |
|-------------|----------------------------------------------------------------------------------|----|
| Figure 1.1  | Host Access to LUNs With LUN Security .....                                      | 2  |
| Figure 1.2  | Host Access to LUNs Without LUN Security .....                                   | 3  |
| Figure 2.1  | Remote Console Main Panel, Information Tab .....                                 | 6  |
| Figure 2.2  | View Mode .....                                                                  | 8  |
| Figure 2.3  | Mode Changing Confirmation Message .....                                         | 8  |
| Figure 2.4  | Modify Mode .....                                                                | 8  |
| Figure 3.1  | LUN Manager/Port Panel, LUN Manager Tab .....                                    | 9  |
| Figure 3.2  | LU Path Outline View (From the LUN Manager/Port Panel,<br>LUN Manager Tab) ..... | 10 |
| Figure 3.3  | LU Path Table (From the LUN Manager/Port Panel, LUN Manager Tab) .....           | 11 |
| Figure 3.4  | WWN/Port Detail (From the LUN Manager/Port Panel, LUN Manager Tab) .....         | 12 |
| Figure 3.5  | LDEV Detail (From the LUN Manager/Port Panel, LUN Manager Tab) .....             | 13 |
| Figure 3.6  | LUN Manager/Port Panel, Port Tab .....                                           | 14 |
| Figure 3.7  | Package Outline View (From the LUN Manager/Port Panel, Port Tab) .....           | 15 |
| Figure 3.8  | Port Table (From the LUN Manager/Port Panel, Port Tab) .....                     | 16 |
| Figure 3.9  | Change Port Mode Box (From the LUN Manager/Port Panel, Port Tab) .....           | 17 |
| Figure 4.1  | LU Path Configuration .....                                                      | 20 |
| Figure 4.2  | LightPulse Utility/NT Panel .....                                                | 23 |
| Figure 4.3  | Sun Solaris® Worldwide Name .....                                                | 24 |
| Figure 4.4  | HP-UX® Worldwide Name .....                                                      | 26 |
| Figure 4.5  | Add New Host Group Pop-Up Menu .....                                             | 28 |
| Figure 4.6  | Add New Host Group Panel .....                                                   | 28 |
| Figure 4.7  | Apply Confirmation Message .....                                                 | 29 |
| Figure 4.8  | Cancel Confirmation Message .....                                                | 29 |
| Figure 4.9  | Add New WWN Pop-Up Menu .....                                                    | 32 |
| Figure 4.10 | Add New WWN Panel .....                                                          | 32 |
| Figure 4.11 | Link Path Confirmation Message .....                                             | 33 |
| Figure 4.12 | Release LU Path Pop-Up Menu .....                                                | 35 |
| Figure 4.13 | Release LU Path Confirmation Message .....                                       | 35 |
| Figure 4.14 | The Change WWN & Name Panel .....                                                | 36 |
| Figure 4.15 | Change Host Group Pop-Up Menu .....                                              | 39 |
| Figure 4.16 | The Change Host Group Panel .....                                                | 39 |
| Figure 4.17 | Copy Pop-Up Menu .....                                                           | 42 |
| Figure 4.18 | Add LUN Security Pop-Up Menu .....                                               | 44 |
| Figure 4.19 | Add LUN Security Confirmation Message .....                                      | 44 |
| Figure 4.20 | Delete LUN Security Pop-Up Menu .....                                            | 46 |
| Figure 4.21 | Delete LUN Security Confirmation Message .....                                   | 46 |
| Figure 4.22 | Add Command Device Pop-Up Menu .....                                             | 49 |
| Figure 4.23 | Assign Command Device Confirmation Message .....                                 | 49 |
| Figure 4.24 | Release Command Device Pop-Up Menu (ON ->OFF) .....                              | 51 |
| Figure 4.25 | Release Command Device Confirmation Message .....                                | 51 |
| Figure 4.26 | Add Command Device Security Pop-Up Menu .....                                    | 53 |
| Figure 4.27 | Add Command Device Security Confirmation Menu .....                              | 53 |
| Figure 4.28 | Release Command Device Security Pop-Up Menu .....                                | 55 |
| Figure 4.29 | Release Command Device Security Confirmation Message .....                       | 55 |

|             |                                                         |    |
|-------------|---------------------------------------------------------|----|
| Figure 4.30 | Host Speed Drop-Down Box.....                           | 57 |
| Figure 4.31 | Fibre-Address Drop-Down Box.....                        | 58 |
| Figure 4.32 | Illustration of FC-AL and Point-to-Point Topology ..... | 60 |
| Figure 4.33 | Fabric On-Off Drop-Down Box.....                        | 62 |
| Figure 4.34 | Connection Drop-Down Box.....                           | 62 |
| Figure 4.35 | Change Port Mode Confirmation Message .....             | 62 |

## List of Tables

|           |                                                      |    |
|-----------|------------------------------------------------------|----|
| Table 1.1 | LUN Manager Supported Volumes.....                   | 1  |
| Table 4.1 | Table of Host Modes .....                            | 30 |
| Table 4.2 | Available Addresses for Fibre-Channel Ports .....    | 59 |
| Table 4.3 | Port Serial Numbers and Port Names (4-port PCB)..... | 64 |
| Table 4.4 | Port Serial Numbers and Port Names (2-port PCB)..... | 66 |
| Table 5.1 | General Error Conditions.....                        | 68 |

# Chapter 1 Overview of LUN Manager and LUN Security

## 1.1 Overview of LUN Manager

The LUN Manager feature of the Lightning 9900™ V Series subsystem enables you to define the SCSI-to-LUN paths using the Remote Console. Each logical unit (LU) can be mapped for access from multiple ports, providing alternate paths for nonstop data availability. In addition, LUN Manager allows you to reconfigure the LUs at any time to accommodate system configuration changes and/or optimize subsystem performance. You can also configure command devices and apply command device security.

LUN Manager enables you to set and define the port modes and set the fibre topology. The 9900V also supports a high-performance mode, in which you will only use one of the four ports. That port will use the channel processors and fibre optic processors (FOPs) that would otherwise be reserved for the other three ports, thereby increasing throughput. For further information on fibre-device addressing and LU configurations, please refer to the *Hitachi Freedom Storage™ Lightning 9900™ V Series User and Reference Guide* (MK-92RD100).

**Note:** Some LUN Manager operations may compromise data integrity. Please verify that you are performing the proper operation on the proper devices.

**Note:** The list of supported volumes in the following table is current as of the publication date of this document. Certain LUN Manager features may be made available in later releases. Contact your Hitachi Data Systems account team for more information.

**Table 1.1 LUN Manager Supported Volumes**

| S/390® Volumes | Open-System Volumes |
|----------------|---------------------|
| 3390-3A/B/C    | OPEN-3              |
|                | OPEN-8              |
|                | OPEN-9              |
|                | OPEN-E              |
|                | OPEN-L              |

## 1.2 Overview of LUN Security

To protect mission-critical data in your disk subsystem from unauthorized access, you should implement LUN security. LUN security allows you to prevent unauthorized open-systems hosts from either seeing or accessing the data on the secured LU. If LUN security is applied to a particular port, that port can only be accessed from within its own host group. Figure 1.1 illustrates LUN security applied to port CL1-A.

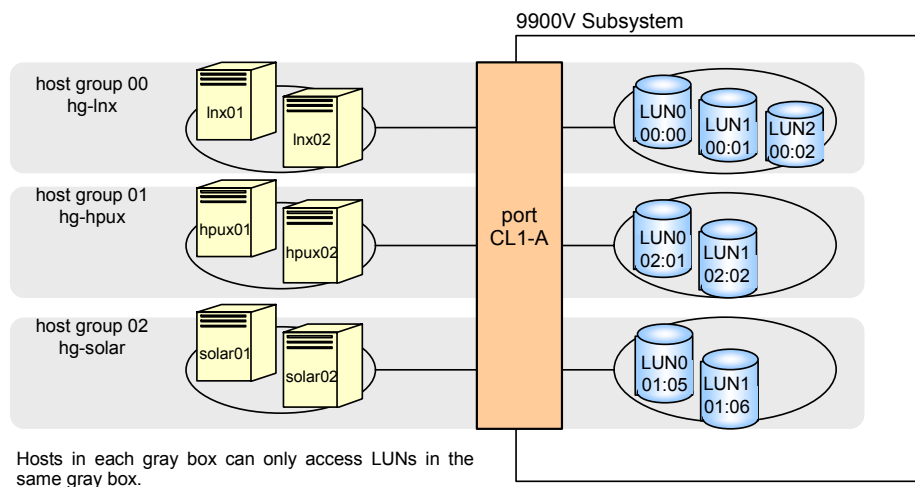
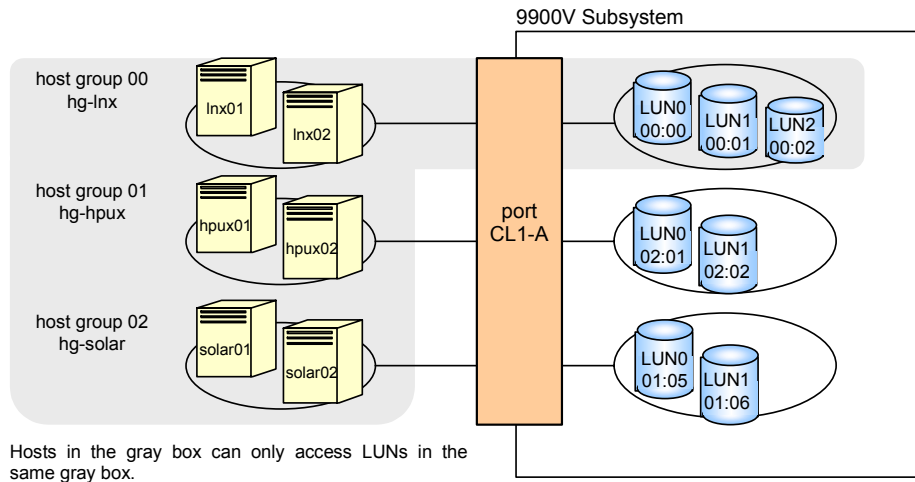

Figure 1.1 Host Access to LUNs With LUN Security

If LUN security is not applied, hosts connected to a particular port will be able to access all of the LUs connected to the same port. Figure 1.2 illustrates host access without LUN security.



**Figure 1.2 Host Access to LUNs Without LUN Security**

By default, **host group 0** is the only host group reserved for each fibre-channel port. If you use the LUN Manager panel to view a list of host groups in a port, host group 0 usually appears at the top of the list and is indicated by the number "00" (see Figure 4.1 for more details on host groups). **Note:** By default, the name of a host group consists of the port name, a hyphen, and the host group number. For example, the default name for host group 0 on port 1A is **1A-G00**. The name can be changed.

By default, LUN security is *not* applied. For details on how to apply LUN security, see section 4.4.





## Chapter 2 Preparing To Use LUN Manager

### 2.1 Set Up the 9900V Subsystem and Remote Console PC(s)

Before launching LUN Manager, you must take several preliminary steps. For detailed instructions, please refer to *Hitachi Freedom Storage™ Lightning 9900™ V Series Remote Console - Storage Navigator User's Guide* (MK-92RD101). These include the following:

- Install the 9900 subsystem.
- Install the PC(s) that you intend to use as Remote Consoles, and connect them to the 9900V internal LAN.
- Enable LUN Manager on each subsystem where you intend to use the option.

## 2.2 Launch LUN Manager

To use LUN Manager, you must first log on to the primary SVP. For detailed instructions on the login process, see *Hitachi Freedom Storage™ Lightning 9900™ V Series Remote Console - Storage Navigator User's Guide* (MK-92RD101).

If you successfully log on to the primary SVP, the Remote Console Main panel opens (see Figure 2.1). The **Option** buttons are displayed vertically on the left side. The **LUN Manager/LUN Security** button (  ) opens the LUN Manager/Port panel (see Figure 3.1).

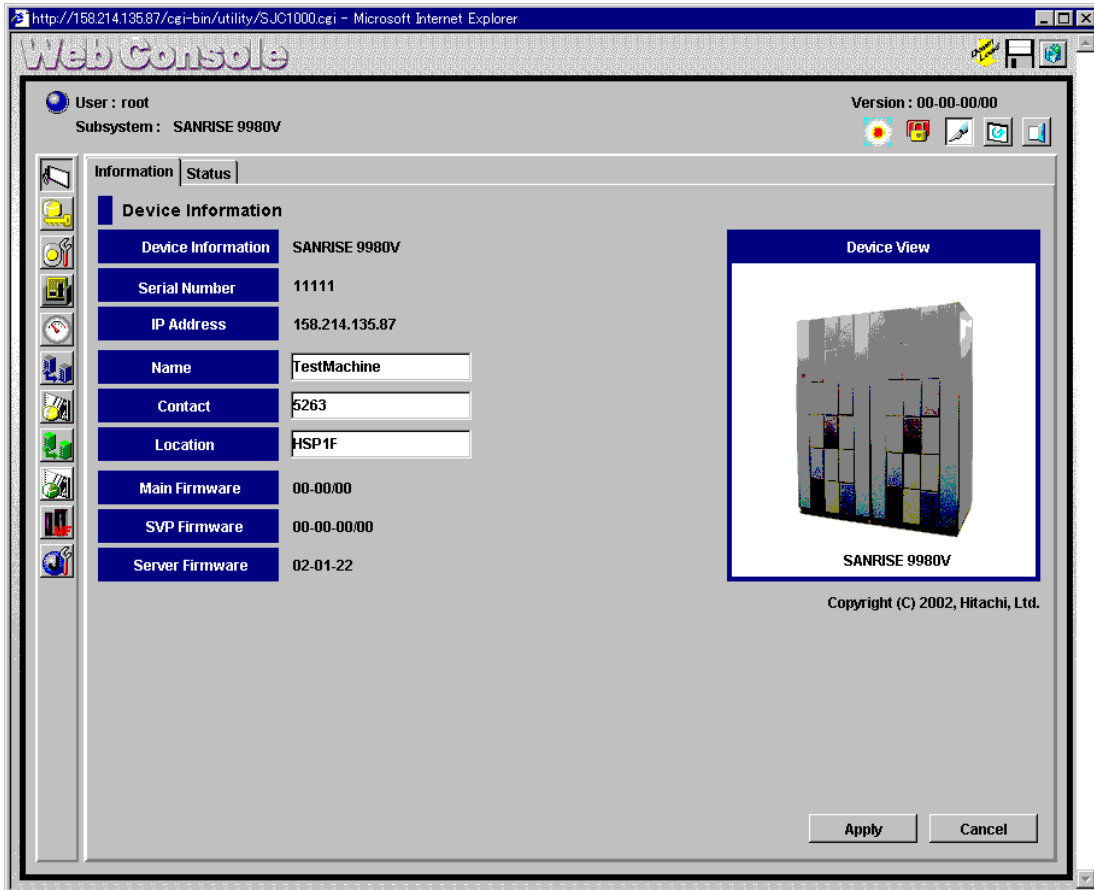





Figure 2.1 Remote Console Main Panel, Information Tab

## 2.3 Changing to Modify Mode

If you are going to implement any changes for LUN Manager or LUN security, you must be in **Modify** mode. The subsystem information icons (see Figure 2.2) are on the upper right corner of the Remote Console Main panel, and they appear on all option panels as well. These icons are described in detail in *Hitachi Freedom Storage™ Lightning 9900™ V Series Remote Console - Storage Navigator (MK-92RD101)*. If you want to change from **View** mode to **Modify** mode and back, two of the icons are important:

- The exclusive lock icons indicate the operation mode of all currently logged-in users. If all users are operating in **View** mode, the **Unlocked** icon () is displayed. If a user is operating in **Modify** mode, or if subsystem maintenance or SNMP operations are being performed, the **Locked** icon () is displayed.
- The **Mode-Changing** buttons allow users to change the operation mode between **View** mode () and **Modify** mode (). **Note:** Only one user at a time can be in **Modify** mode.

### To change between View mode to Modify mode:







1. You must have administrator or write access for the option that you want to use. For details on assigning user access, see *Hitachi Freedom Storage™ Lightning 9900™ V Series Remote Console - Storage Navigator (MK-92RD101)*.
2. Verify that the subsystem is unlocked. If all users are operating in **View** mode, the **Unlocked** icon () and the **View Mode** icon () are displayed (see Figure 2.2). If a user is operating in **Modify** mode, or if subsystem maintenance is being performed, the **Locked** icon () is displayed, and you will not be able to implement changes.
3. Select the **Mode Changing** icon, which should be in **View** mode (). Click on the icon, and a confirmation message will display (see Figure 2.3). Select **OK**.
4. Once you are in **Modify** mode, the **Mode Changing** icon will change from a gray background to a yellow background (), and the **Locked** icon () is displayed (see Figure 2.4).
5. Once you have applied your desired changes, you need to change back to **View** mode. Select the **Mode Changing** icon (). The confirmation message will display (see Figure 2.3). Select **OK**, and you will be back in **View** mode.



Figure 2.2 View Mode



Figure 2.3 Mode Changing Confirmation Message

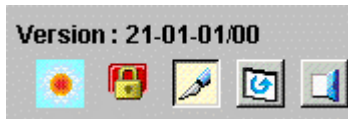



Figure 2.4 Modify Mode

# Chapter 3 The LUN Manager Panels

## 3.1 LUN Manager/Port Panel, LUN Manager Tab

The LUN Manager/LUN Security button (  ) on the Remote Console main panel (refer to Figure 2.1) opens the LUN Manager/Port panel. The LUN Manager tab is the default view (see Figure 3.1). The LUN Manager tab allows you define LU paths, apply LUN security , and assign command devices.

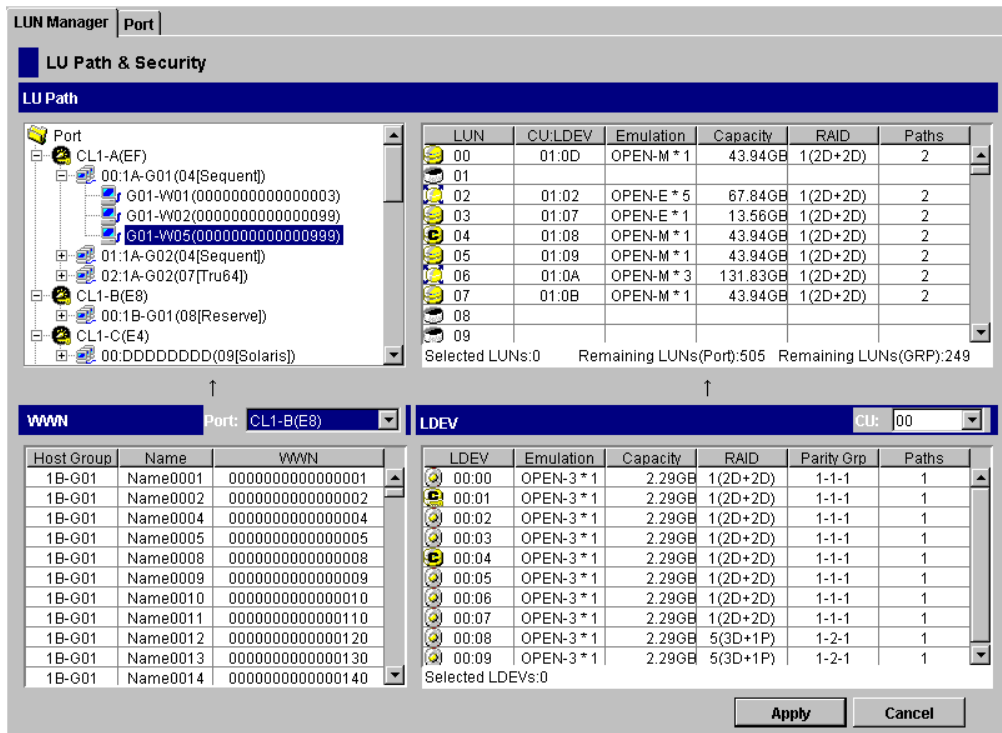

Figure 3.1 LUN Manager/Port Panel, LUN Manager Tab

Figure 3.2 shows the detail on the outline view, which is on the upper left corner of the LUN Manager tab.

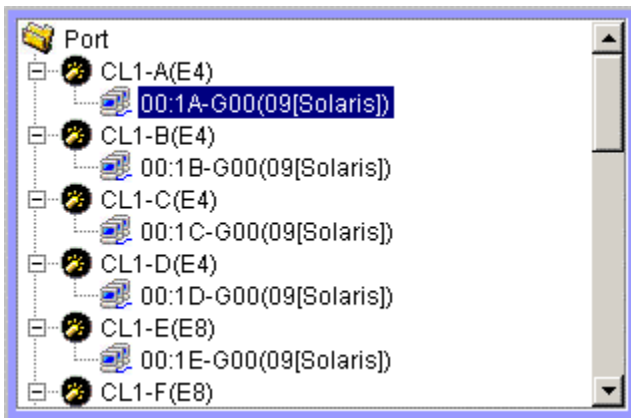

Figure 3.2 LU Path Outline View (From the LUN Manager/Port Panel, LUN Manager Tab)

The LU Path Outline View displays the fibre-channel ports and the connected hosts. The host bus adapters are identified by names and WorldWide Names (WWNs), and are classified by host groups.











When you double-click the **Port** folder (📁), you will see an icon, the port name and port address. The icon will be one of the following:

- 🖱️ indicates a short-wave port in **Standard** mode, with LUN security not applied.
- 🖱️🔑 indicates a short-wave port in **Standard** mode. The addition of a key to the icon indicates that LUN security is applied to the port.
- 🖱️🌊 indicates a long-wave port in **Standard** mode, with LUN security not applied.
- 🖱️🌊🔑 indicates a long-wave port in **Standard** mode. The addition of a key to the icon indicates that LUN security is applied to the port.
- 🖱️🔑 indicates a short-wave port in **High-Speed** mode, with LUN security not applied.
- 🖱️🔑 indicates a short-wave port in **High-Speed** mode. The addition of a key to the icon indicates that LUN security is applied to the port.
- 🖱️🌊 indicates a long-wave port in **High-Speed** mode, with LUN security not applied.
- 🖱️🌊🔑 indicates a long-wave port in **High-Speed** mode. The addition of a key to the icon indicates that LUN security is applied to the port.

When you double-click a port in the outline view, the Host Group icon (🖱️), the host group name and the host mode are displayed. If LUN security is not applied, all host groups except for the first group (host group 0) are grayed out. For details on creating host groups and host modes, see section 4.2.2.





When you double-click a host group in the outline view, the WWN icon (🖱️), the name and the worldwide name (WWN) of the host bus adapter are displayed. For details on changing the WWN and name of host bus adapters, see section 4.3.2.

When you select a host group in the outline view, the **LU Path Table** (on the upper right corner of the panel; see Figure 3.3) shows information about each of the LUNs in the selected group.

| LUN                                                                                  | CU:LDEV | Emulation | Capacity | RAID     | Paths |
|--------------------------------------------------------------------------------------|---------|-----------|----------|----------|-------|
|  00 | 00:00   | OPEN-L *1 | 33.94GB  | 1(2D+2D) | 1     |
|  01 | 00:01   | OPEN-L *1 | 33.94GB  | 1(2D+2D) | 1     |
|  02 | 00:02   | OPEN-L *1 | 33.94GB  | 1(2D+2D) | 1     |
|  03 | 00:03   | OPEN-L *1 | 33.94GB  | 1(2D+2D) | 1     |
|  04 | 00:10   | OPEN-L *1 | 33.94GB  | 1(2D+2D) | 1     |
|  05 | 00:11   | OPEN-L *1 | 33.94GB  | 1(2D+2D) | 1     |
|  06 | 00:12   | OPEN-L *1 | 33.94GB  | 1(2D+2D) | 1     |
|  07 | 00:13   | OPEN-L *1 | 33.94GB  | 1(2D+2D) | 1     |
|  08 | 00:20   | OPEN-L *1 | 33.94GB  | 1(2D+2D) | 1     |
|  09 | 00:21   | OPEN-L *1 | 33.94GB  | 1(2D+2D) | 1     |

Selected LUNs:0      Remaining LUNs(Port):480      Remaining LUNs(GRP):224

**Figure 3.3 LU Path Table (From the LUN Manager/Port Panel, LUN Manager Tab)**

- The **LUN** column displays the logical unit numbers (LUNs) that are assigned to logical volumes. If no paths are defined, the other columns on the right are left blank. The icon will be one of the following:
  -  indicates a logical volume to which an LU path is defined.
  -  indicates an expanded LU.
  -  indicates a command device.
  -  indicates a secured command device.
  -  indicates a LUN to which no LU path is defined.
- The **CU:LDEV** column indicates the CU image number and LDEV number, which are used to identify a logical volume (LDEV).
- The **Emulation** column displays the emulation type for each LDEV.
- The **Capacity** column displays the size of each LDEV.
- The **RAID** column displays the RAID level for each LDEV.
- The **Paths** column displays the number of alternate paths, if any, for each LDEV.
- The **Selected LUNs** entry displays the number of LUNs that have been selected in the LU Path table.
- The **Remaining LUNs (Port)** entry displays the number of LUNs to which no LU path has been defined. This indicates the number of LU paths that you can add to the port specified in the outline view.
- The **Remaining LUNs (GRP)** entry displays the number of LUNs to which no LU path has been defined. This indicates the number of LU paths that you can add to the host group specified in the outline view.

The WWN/Port Detail (see Figure 3.4) is on the lower left of the LUN Manager tab.

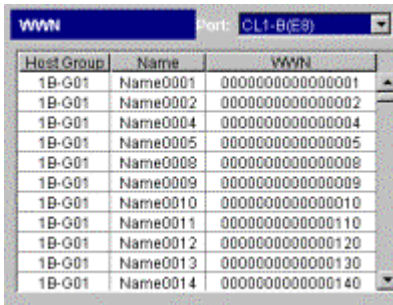

| Host Group | Name     | WWN              |
|------------|----------|------------------|
| 1B-G01     | Name0001 | 0000000000000001 |
| 1B-G01     | Name0002 | 0000000000000002 |
| 1B-G01     | Name0004 | 0000000000000004 |
| 1B-G01     | Name0005 | 0000000000000005 |
| 1B-G01     | Name0009 | 0000000000000009 |
| 1B-G01     | Name0009 | 0000000000000009 |
| 1B-G01     | Name0010 | 0000000000000010 |
| 1B-G01     | Name0011 | 0000000000000011 |
| 1B-G01     | Name0012 | 0000000000000012 |
| 1B-G01     | Name0013 | 0000000000000013 |
| 1B-G01     | Name0014 | 0000000000000014 |

**Figure 3.4 WWN/Port Detail (From the LUN Manager/Port Panel, LUN Manager Tab)**

The WWN/Port Detail shows information about the host bus adapters that are connected to fibre-channel ports of the disk subsystem.

- The **Port** drop-down box shows the selected port.
- The **Host Group** column shows the groups of open-system host(s) that are attached to the subsystem.
- The **Name** column indicates the names that are assigned to the host bus adapters.
- The **WWN** column indicates the WorldWide Names of the host bust adapters.







The **LDEV Detail** (see Figure 3.5) is on the lower right of the **LUN Manager** tab, and displays information about the LDEVs that are in the subsystem.

| LDEV  | Emulation  | Capacity | RAID     | Parity Grp | Paths |
|-------|------------|----------|----------|------------|-------|
| 00:04 | OPEN-L * 1 | 33.94GB  | 5(3D+1P) | 1-1-1      |       |
| 00:05 | OPEN-L * 1 | 33.94GB  | 5(3D+1P) | 1-1-1      |       |
| 00:0A | OPEN-L * 1 | 33.94GB  | 5(3D+1P) | 1-2-1      |       |
| 00:0B | OPEN-L * 1 | 33.94GB  | 5(3D+1P) | 1-2-1      |       |
| 00:0C | OPEN-L * 1 | 33.94GB  | 5(3D+1P) | 1-3-1      | 1     |
| 00:0D | OPEN-L * 1 | 33.94GB  | 5(3D+1P) | 1-3-1      | 1     |
| 00:0E | OPEN-L * 1 | 33.94GB  | 5(3D+1P) | 1-3-1      | 1     |
| 00:0F | OPEN-L * 1 | 33.94GB  | 5(3D+1P) | 1-3-1      | 1     |
| 00:10 | OPEN-L * 1 | 33.94GB  | 5(3D+1P) | 1-3-1      |       |
| 00:11 | OPEN-L * 1 | 33.94GB  | 5(3D+1P) | 1-3-1      |       |

Selected LDEVs:0

**Figure 3.5 LDEV Detail (From the LUN Manager/Port Panel, LUN Manager Tab)**

- The **CU** drop-down box displays the selected CU image.
- The **LDEV** column displays an icon, the CU number and the LDEV ID. The icons are as follows:
  -  indicates a normal logical volume.
  -  indicates an expanded LU.
  -  indicates a command device.
  -  indicates a secured command device.
- The **Emulation** column displays the emulation types for each LDEV.
- The **Capacity** column displays the size of each logical volume.
- The **RAID** column displays the RAID level for each logical volume.
- The **Parity Grp** column displays names of parity groups.
- The **Paths** column displays the number of alternate paths, if any.
- The **Selected LDEVs** entry displays the number of LDEVs selected.
- The **Apply** button implements the settings that have been made in this panel.
- The **Cancel** button cancels the settings that have been made in this panel.

### 3.2 LUN Manager/Port Panel, Port Tab

The LUN Manager/LUN Security button (  ) on the Remote Console main panel (refer to Figure 2.1) opens the LUN Manager/Port panel. The LUN Manager tab is the default view (see Figure 3.1). Select the Port tab (see Figure 3.6). The Port tab allows you to configure fibre-channel ports.

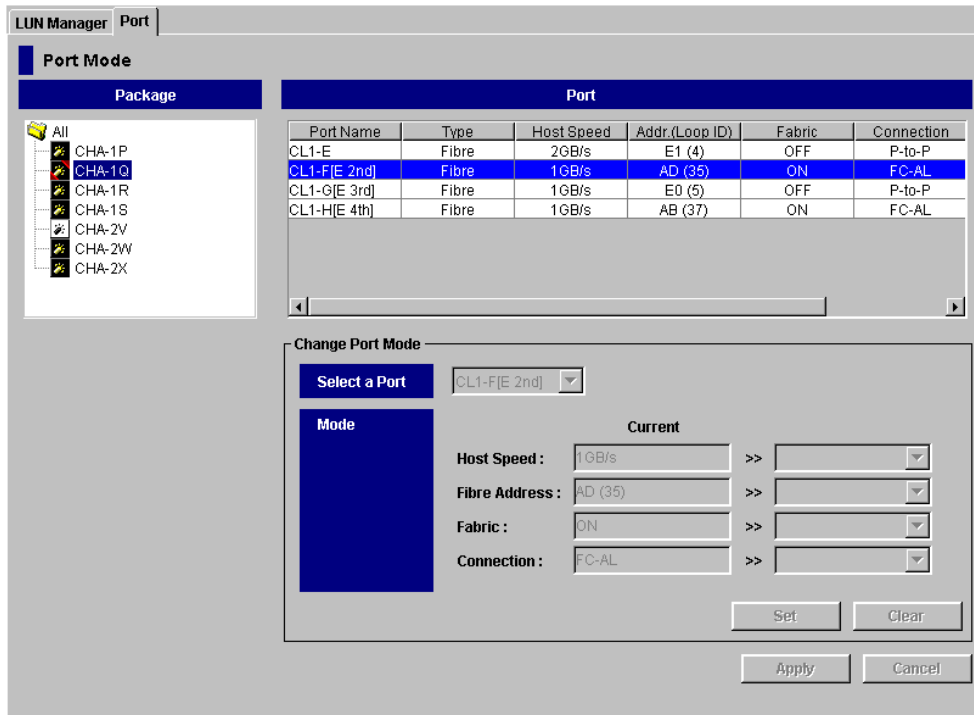





Figure 3.6 LUN Manager/Port Panel, Port Tab

The **Package** outline view (see Figure 3.7) is on the upper left of the **Port** tab.



**Figure 3.7 Package Outline View (From the LUN Manager/Port Panel, Port Tab)**

- When you double-click the **All** folder, the folder opens and lists channel adapter (CHA) packages. The icon will be one of the following:
  -  indicates a short-wave CHA package in standard mode
  -  indicates a long-wave CHA package in standard mode
  -  indicates a short-wave CHA package in high-speed mode
  -  indicates a long-wave CHA package in high-speed mode

The **Port** table (see Figure 3.8) is on the upper right of the **Port** tab, and displays information about the ports in the selected channel adapter package. You can use the options in the **Change Port Mode** box (see Figure 3.9) to change information in this table.

| Port      |       |            |                |        |           |
|-----------|-------|------------|----------------|--------|-----------|
| Port Name | Type  | Host Speed | Addr.(Loop ID) | Fabric | Connector |
| CL1-A     | Fibre | 2GB/s      | E4 (2)         | OFF    | FC-AL     |
| CL1-B     | Fibre | 2GB/s      | E4 (2)         | OFF    | FC-AL     |
| CL1-C     | Fibre | 2GB/s      | E4 (2)         | OFF    | FC-AL     |
| CL1-D     | Fibre | 2GB/s      | E4 (2)         | OFF    | FC-AL     |
| CL1-E     | Fibre | 2GB/s      | E8 (1)         | OFF    | FC-AL     |
| CL1-F     | Fibre | 2GB/s      | E8 (1)         | OFF    | FC-AL     |
| CL1-G     | Fibre | 2GB/s      | E8 (1)         | OFF    | FC-AL     |
| CL1-H     | Fibre | 2GB/s      | E8 (1)         | OFF    | FC-AL     |

Figure 3.8 Port Table (From the LUN Manager/Port Panel, Port Tab)

- The **Port Name** column displays the port name. For details, see Table 4.3.
- The **Type** column displays the port type.
  - **MF-Serial** indicates an ESCON port, which is used for connecting mainframe hosts.
  - **Fibre** indicates a fibre-channel port, which is used for connecting open-system hosts.
- The **Host Speed** column allows you to specify the data transfer speed for fibre-channel ports. If **Auto** is selected, the disk subsystem automatically sets the data transfer speed to 1GBPS or 2GBPS.
- **Addr. (Loop ID)** displays addresses of ports.
- The **Fabric** column indicates whether a fabric switch is used.
- The **Connection** column allows you to specify the topology. The default is **FC-AL**.
 

**Note:** Certain fabric switches require you to specify Point-to-Point topology. If your system uses a fabric switch, refer to the documentation for the fabric switch.
- The **WWN** column displays the WWNs of the host bus adapters.

The **Change Port Mode** box (see Figure 3.9) is on the lower right of the **Port** tab.

The screenshot shows a dialog box titled "Change Port Mode". At the top left, there is a "Select a Port" section with a dropdown menu currently showing "CL1-A". Below this is a "Mode" section with a dark blue background. To the right of the "Mode" section is a "Current" section with four rows of configuration options: "Host Speed" (2GB/s), "Fibre Address" (E4 (2)), "Fabric" (OFF), and "Connection" (FC-AL). Each row has a text box on the left and a dropdown menu on the right, separated by a double arrow ">>". At the bottom right of the dialog are "Set" and "Clear" buttons.

Figure 3.9 Change Port Mode Box (From the LUN Manager/Port Panel, Port Tab)

The **Change Port Mode** box allows you to change the information in the **Port** table (refer to Figure 3.8).

- The **Select a Port** drop-down box allows you to select a port for configuration.
- The **Host Speed** text box on the left displays the data transfer speed for the selected port. The drop-down list on the right allows you specify the data transfer speed for the selected port. If **Auto** is selected, the disk subsystem automatically sets the data transfer speed to 1GBPS or 2GBPS. For instructions on changing the host speed, see section 4.6.1.
- The **Fibre Address** text box on the left displays the address of the selected port. The drop-down list on the right allows you specify the address of the selected port. For instructions on changing the host address, see section 4.6.2.
- The **Fabric** text box on the left indicates whether a fabric switch is used. It must be set to **ON** if a fabric switch is used or to **OFF** if a fabric switch is not used. The drop-down list on the right allows you specify whether a fabric switch is used. For instructions on changing to a fabric switch, see section 4.6.3.
- The **Connection** text box on the left indicates the topology, which can be either **FC-AL** or **P-to-P** (Point-to-Point). The drop-down list on the right allows you specify the topology. **Note:** Certain fabric switches require you to specify Point-to-Point topology. If your system uses a fabric switch, refer to the documentation for the fabric switch to determine whether your change requires the Point-to-Point topology. For instructions on changing the fibre-channel topology, see section 4.6.3.



## Chapter 4 LUN Manager Operations

LUN Manager operations include the following:

- Defining LU paths (see section 4.2)
- Changing LU paths (see section 4.3)
- Using LUN security (see section 4.4)
- Configuring command devices (see section 4.5)
- Configuring fibre-channel ports (see section 4.6)

### 4.1 Overview of Logical Volume and LU Path Configuration

After open-system hosts and the disk subsystem are physically connected, you must use LUN Manager to establish I/O paths between the hosts and the logical volumes. These LU paths define which hosts are able to access which logical volumes. Before defining LU paths, you must classify server hosts by host groups. Host groups have the following characteristics:

- Host groups are used to segregate hosts by operating system. For example, if you have a Windows® host and a Linux® host attached to the same subsystem, you must create a Windows® host group and a Linux® host group, and register the host bus adapters in the corresponding host group.
- All of the hosts in a host group must be connected to the same port.
- Up to 256 LU paths can be defined for one host group. The maximum number of LUNs per physical port is 512 but you cannot put more than 256 LUNs in a LUN group so any one host should never be able to see more than 256 LUNs per port.
- Up to 128 host groups can be created for one fibre-channel port. Up to 8,192 host groups can be created for one disk subsystem.

After server hosts are classified into host groups, you must link the host groups to logical volumes. In Figure 4.1, the **hg-lnx** host group is associated with logical volumes 00:00, 00:01, and 00:02. The LU identified by the CU-LDEV number **00:00** is accessible from the two hosts that belong to that host group. The LUs associated with the **hg-lnx** group are addressed by numbers 0 to 2.

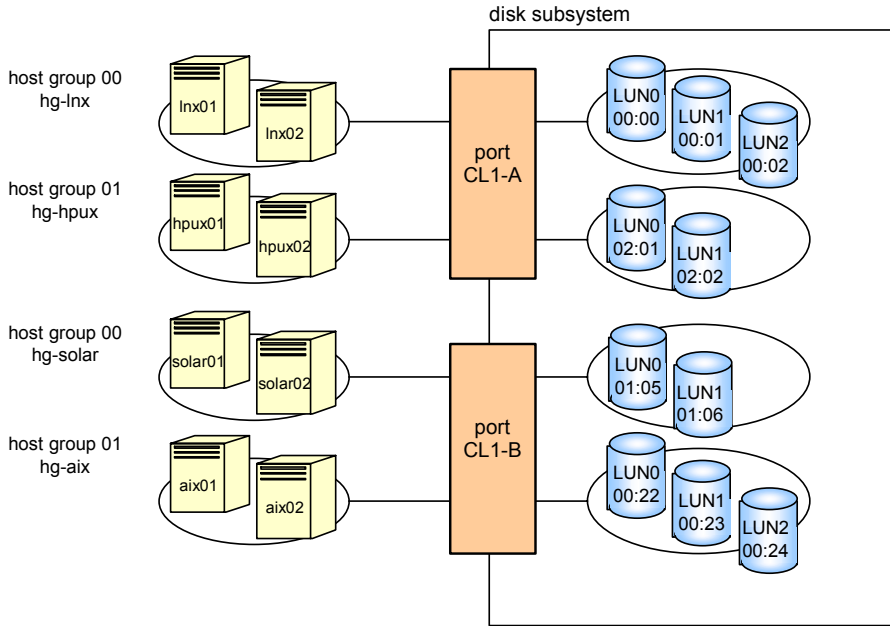
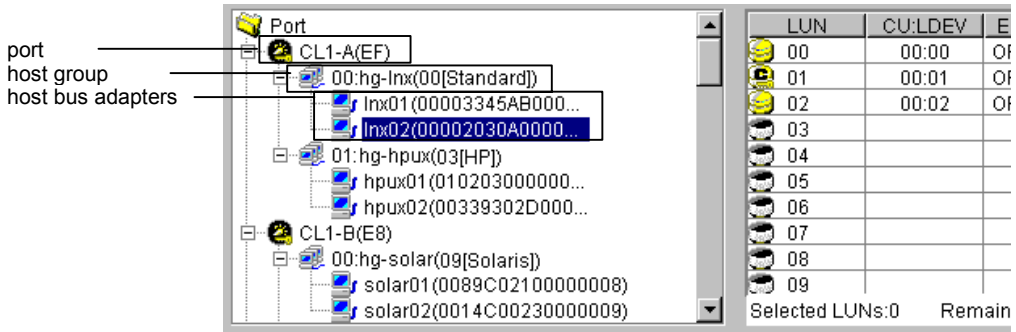

Figure 4.1 LU Path Configuration



## 4.2 Defining LU Paths

The steps for defining LU paths are as follows:

- Finding the worldwide names (WWNs) of the host bus adapters (see section 4.2.1)
- Creating host groups (see 4.2.2)
- Grouping open-system hosts by host groups (see 4.2.3)
- Associating host groups with LUs (see 4.2.4)

**Note:** You cannot define LU paths to the following types of volumes:

- Volumes reserved for Hitachi CruiseControl
- On-Demand volumes

### 4.2.1 Finding the Worldwide Names (WWNs) of the Host Bus Adapters

Platform-specific instructions for finding the WWN of a specific HBA are found in the following sections:

- Windows NT<sup>®</sup> and Windows<sup>®</sup> 2000 are discussed in section 4.2.1.1
- Sun<sup>®</sup> Solaris<sup>™</sup> is discussed in section 4.2.1.2.
- AIX<sup>®</sup>, SGI IRIX<sup>®</sup> and Sequent<sup>®</sup> are discussed in section 4.2.1.3.
- HP-UX<sup>®</sup> is discussed in section 4.2.1.4.

The Worldwide Name is a unique identifier for a particular open-system host, consisting of a 64 bit physical address (the IEEE 48-bit format with 12-bit extension and 4-bit prefix). The WWN is essential in defining the LUN security parameters, because it is the key that either allows or denies an open-system host's access to a specified LU or group of LUs.

After you have installed and configured the subsystem, you must obtain the WWN from each open-system host that you want to use for LUN security. Hitachi Data Systems supports different fibre-channel adapters for different open-systems platforms. Sections 4.2.1.1 through 4.2.1.4 describe how to find the WWN for specific open-systems hosts. Please read the instructions carefully to ensure that the correct adapter is installed on the correct open-systems platform.

#### 4.2.1.1 Finding the WWN for Windows NT® or Windows® 2000

Hitachi Data Systems currently supports the Emulex® fibre-channel adapter in a Windows NT® or Windows® 2000 environment, and will support other adapters in the future. For further information on fibre-channel adapter support, or if you are using a fibre-channel adapter other than Emulex®, please contact the Hitachi Data Systems technical support center for instructions on finding the WWN.

To find the WWN in a Windows NT® or Windows® 2000 environment with an Emulex® Mini-Port Driver:

**Note:** Although these instructions are written for a Windows NT® environment, similar instructions apply in a Windows® 2000 environment.

1. Verify that the fibre adapters and the fibre-channel device drivers are installed.
2. Log in to the Windows NT® or Windows® 2000 host with administrator access.
3. Go to the **LightPulse™** utility to open the LightPulse Utility/NT panel (see Figure 4.2). If you do not have a shortcut to the utility, do the following:
  - a) Go to the **Start** menu, and select **Find** and choose the **Files and Folders** option. The Find panel will open.
  - b) On the Find panel in the **Named** text field enter `lputilnt.exe`. In the **Look in** list box choose the hard drive that contains the Emulex® mini-port driver.
  - c) Choose **Find Now** to search for the LightPulse™ utility. **Note:** If you cannot find the LightPulse™ utility, contact Emulex® technical support.
  - d) Select **lputilnt.exe** from the **Find: Files named** list box then press **Enter**. The LightPulse™ Utility/NT® panel opens.
4. On the LightPulse™ Utility/NT® panel, the installed adapter(s) are displayed in list box on the left of the panel. Verify that the installed adapter(s) are displayed.
5. On the LightPulse™ Utility/NT® panel, in the **Category** list box, choose the **Configuration Data** option, and in the **Region** list box choose the **16 World-Wide Name** option. The WWN of the selected adapter is displayed in the list box on the right of the panel.

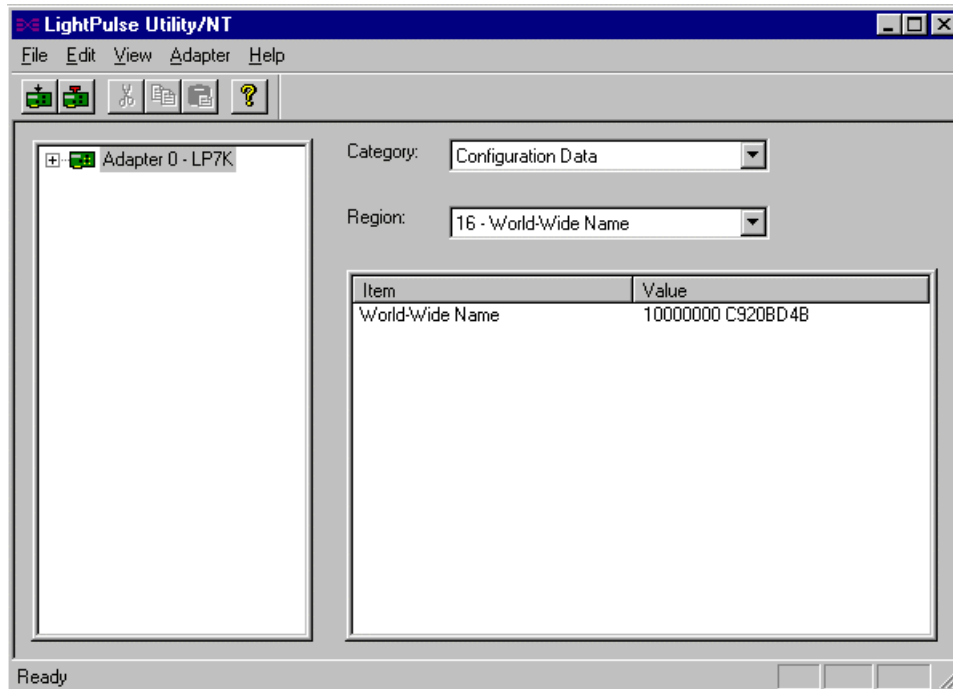

Figure 4.2 LightPulse Utility/NT Panel

### 4.2.1.2 Finding the WWN for Sun Solaris™

Hitachi Data Systems currently supports the JNI® fibre-channel adapter in a Sun Solaris™ environment. This document will be updated as needed to cover future adapter-specific information as those adapters are supported. For further information on fibre-channel adapter support, or if you are using a fibre-channel adapter other than JNI®, please contact the Hitachi Data Systems technical support center for instructions for finding the WWN.

To find the WWN in a Sun Solaris™ environment:

1. Verify that the fibre adapters and the fibre-channel device drivers are installed.
2. Login to the Sun Solaris™ host with root access.
3. To list the installed fibre-channel device(s) and their WWN(s) (see Figure 4.3), type:  
`dmesg |grep Fibre`
4. Verify that the fibre-channel adapter(s) listed are correct, and record the listed WWN(s).

|                                                                                                                                                                                                                |                                                                                                  |
|----------------------------------------------------------------------------------------------------------------------------------------------------------------------------------------------------------------|--------------------------------------------------------------------------------------------------|
| <pre># dmesg  grep Fibre : fcaw1: JNI Fibre Channel Adapter model FCW fcaw1: Fibre Channel WWN: 200000e0694011a4 fcaw2: JNI Fibre Channel Adapter model FCW fcaw2: Fibre Channel WWN: 200000e06940121e #</pre> | <p>← Enter the <code>dmesg</code> command.</p> <p>← Record the WWN.</p> <p>← Record the WWN.</p> |
|----------------------------------------------------------------------------------------------------------------------------------------------------------------------------------------------------------------|--------------------------------------------------------------------------------------------------|

Figure 4.3 Sun Solaris® Worldwide Name

### 4.2.1.3 Finding the WWN for AIX®, SGI IRIX®, or Sequent®

To find the WWN in an AIX®, SGI IRIX®, or Sequent® environment, use the fibre switch that is connected to the host. The method of finding the WWN of the connected server on each port using the fibre switch depends on the type of change. For instructions on finding the WWN, refer to the manual of the corresponding change.

#### 4.2.1.4 Finding the WWN for HP-UX®

To find the WWN in an HP-UX® environment (see Figure 4.4):

1. Verify that the fibre adapters and the fibre-channel device drivers are installed.
2. Log in to the HP-UX® host with root access.
3. At the command line prompt type:  
`/usr/sbin/ioscan -fnC lan`
4. This will list the attached fibre-channel devices and their device file names. Record the fibre-channel device file name (for example, `/dev/fcms0`).
5. Use the `fcmsutil` command along with the fibre-channel device name to list the WWN for that fibre-channel device. For example, to list the WWN for the device with the device file name `/dev/fcms0`, type:  
`/opt/fcms/bin/fcmsutil /dev/fcms0`  
**Note:** When the A5158 fibre-channel adapter is used, to find the device name type:  
`/usr/sbin/ioscan -fnC fc`
6. Record the fibre-channel device file name (for example, `/dev/td0`). **Note:** When the A5158 fibre-channel adapter is used, you would list the WWN for the device with the device file name as follows:  
`/opt/fcms/bin/fcmsutil <device file name>`
7. Record the WWN and repeat the above steps for each fibre-channel device that you want to use.

```

# /usr/sbin/ioscan -fnC lan                               ← Enter the ioscan command.
Class      I  H/W Path  Driver      S/W State  H/W Type  Description
=====
lan        0  8/0.5    fcTl_cntl   CLAIMED    INTERFACE  HP Fibre Channel Mass Storage
Cntl

                /dev/fcms0
                ↩ ↩ ↩      Device file name.
lan        4  8/4.5    fcTl_cntl   CLAIMED    INTERFACE  HP Fibre Channel Mass Storage
Cntl

                /dev/fcms4
                ↩ ↩ ↩      Device file name.
lan        5  8/8.5    fcTl_cntl   CLAIMED    INTERFACE  HP Fibre Channel Mass Storage
Cntl

                /dev/fcms5
                ↩ ↩ ↩      Device file name.
lan        6  8/12.5   fcTl_cntl   CLAIMED    INTERFACE  HP Fibre Channel Mass Storage
Cntl

                /dev/fcms6
                ↩ ↩ ↩      Device file name.
lan        1  10/8/1/0  btlan4      CLAIMED    INTERFACE  PCI(10110009) -- Built-in #1
lan        2  10/8/2/0  btlan4      CLAIMED    INTERFACE  PCI(10110009) -- Built-in #2
lan        3  10/12/6   lan2        CLAIMED    INTERFACE  Built-in LAN
                /dev/diag/lan3 /dev/ether3 /dev/lan3
# # fcmsutil /dev/fcms0                                  ← Enter the fcmsutil command.
                Local N_Port_ID is = 0x000001
                N_Port Node World Wide Name = 0x10000060B0C08294
                N_Port Port World Wide Name = 0x10000060B0C08294 ← Record the WWN.
                Topology = IN_LOOP
                Speed = 1062500000 (bps)
                HPA of card = 0xFFB40000
                EIM of card = 0xFFFA000D
                Driver state = READY
                Number of EDB's in use = 0
                Number of OIB's in use = 0
                Number of Active Outbound Exchanges = 1
                Number of Active Login Sessions = 2
#

```

**Figure 4.4** HP-UX® Worldwide Name

## 4.2.2 Creating Host Groups

You can connect multiple server hosts of different platforms to a single fibre-channel port, but you must group server hosts connected to the disk subsystem by host groups, which are segregated by platform. For example, if both HP-UX® hosts and Windows® hosts are connected to a single fibre-channel port, you must create a separate host group for each platform, then register the hosts to the corresponding host group.

The following procedure describes how to create a host group. The procedure for registering hosts to a host group will be described in section 4.2.3.

To create a host group:

1. Change to **Modify** mode. Refer to section 2.3 if you need instructions.
2. Select the **LUN Manager/LUN Security** button () on the Remote Console main panel (refer to Figure 2.1) to open the LUN Manager/Port panel. The **LUN Manager** tab is the default view (refer to Figure 3.1).
3. In the **LU Path** outline view (on the upper left corner of the panel; refer to Figure 3.2), find the port for which you want to create a host group, and verify that LUN security has been applied to that port. **Note:** If the icon has a key on it, LUN security has been applied. See section 4.4 for instructions for applying or removing LUN security.
4. Right-click the port and then select **Add New Host Group** from the pop-up menu (see Figure 4.5) to display the Add New Host Group panel (see Figure 4.6).
5. Enter the host group name in the **Group Name** box. Host group names can be up to eight alphanumeric characters long and are case-sensitive.
6. Select the appropriate host mode from the **Host Mode** drop-down list. See Table 4.1 for a list of host modes. **Caution:** Do not select **Reserve** from the drop-down list. **Reserve** indicates that the host mode is not currently supported.
7. Select **OK**. The changes are not yet applied to the subsystem.
8. If you want to apply the changes to the subsystem, select **Apply** and then select **OK** on the confirmation message (refer to Figure 4.7).
9. If you want to cancel the changes and not apply them to the subsystem, select **Cancel** and then select **OK** on the confirmation message (refer to Figure 4.8).

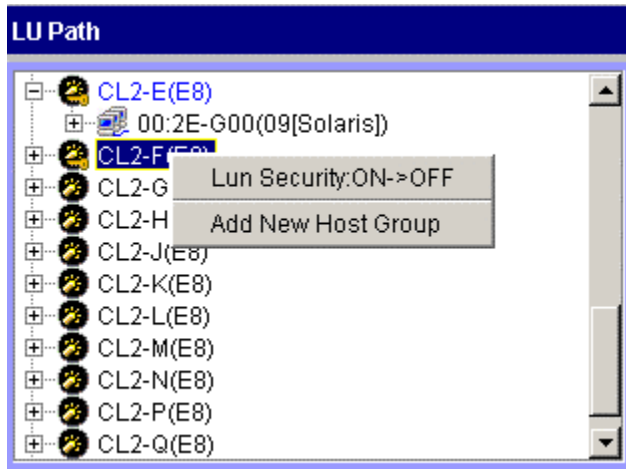

Figure 4.5 Add New Host Group Pop-Up Menu

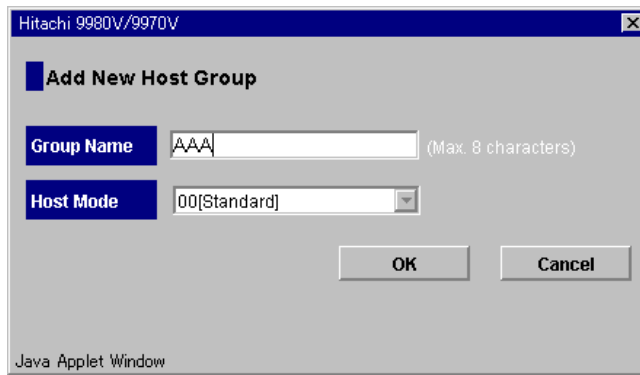

Figure 4.6 Add New Host Group Panel



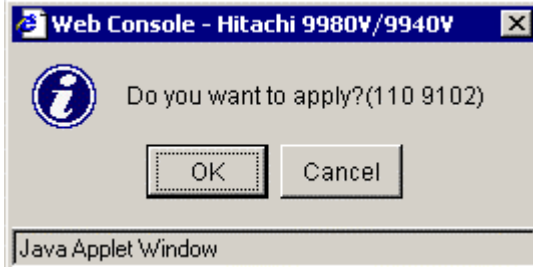

Figure 4.7 Apply Confirmation Message

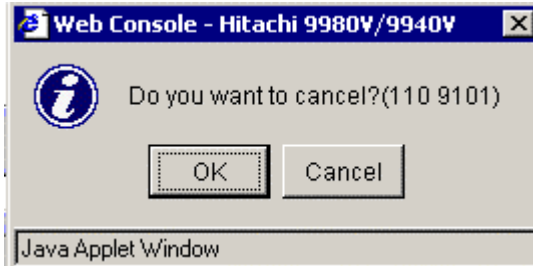

Figure 4.8 Cancel Confirmation Message

**Table 4.1 Table of Host Modes**

| Host mode   | Host Platforms               |
|-------------|------------------------------|
| 00 Standard | Red Hat Linux®, IRIX®        |
| 01 Reserve  | Do not select this host mode |
| 02 Reserve  | Do not select this host mode |
| 03 HP       | HP-UX®                       |
| 04 Sequent  | DYNIX/ptx®                   |
| 05 Open VMS | Open VMS®                    |
| 06 Reserve  | Do not select this host mode |
| 07 Tru64    | Tru64™                       |
| 08 Reserve  | Do not select this host mode |
| 09 Solaris  | Solaris™                     |
| 0A NetWare  | NetWare®                     |
| 0B Reserve  | Do not select this host mode |
| 0C Windows  | Windows® 2000, Windows NT®   |
| 0D Reserve  | Do not select this mode      |
| 0E Reserve  | Do not select this mode      |
| 0F AIX      | AIX®                         |
| 10 Reserve  | Do not select this host mode |
| 11 Reserve  | Do not select this host mode |
| 12 Reserve  | Do not select this host mode |
| 13 Reserve  | Do not select this host mode |
| 14 Reserve  | Do not select this host mode |
| 15 Reserve  | Do not select this host mode |
| 16 Reserve  | Do not select this host mode |
| 17 Reserve  | Do not select this host mode |
| 18 Reserve  | Do not select this host mode |
| 19 Reserve  | Do not select this host mode |
| 1A Reserve  | Do not select this host mode |
| 1B Reserve  | Do not select this host mode |
| 1C Reserve  | Do not select this host mode |
| 1D Reserve  | Do not select this host mode |
| 1E Reserve  | Do not select this host mode |
| 1F Reserve  | Do not select this host mode |

### 4.2.3 Registering Hosts in Host Groups

If the **WWN/Port** detail (on the lower left of the LUN Manager tab; refer to Figure 3.4) includes a host that you want to register, you can register the host by dragging the host from the **WWN/Port** detail to the desired host group in the **LU Path** outline view (on the upper left of the LUN Manager tab; refer to Figure 3.2).

To manually register a host in a host group:

1. Change to **Modify** mode (refer to section 2.3 if you need instructions).
2. Select the **LUN Manager/LUN Security** button () on the Remote Console main panel (refer to Figure 2.1) to open the LUN Manager/Port panel. The **LUN Manager** tab is the default view (refer to Figure 3.1).
3. In the **LU Path** outline view (on the upper left of the panel; refer to Figure 3.2), find the port for which you want to create a host group, and verify that LUN security has been applied to that port. **Note:** If the icon has a key on it, LUN security has been applied. See section 4.4 for instructions for applying or removing LUN security.
4. If the desired host is already connected to another port in the subsystem, take the following steps:
  - On the **WWN Port** detail (on the lower left of the panel; refer to Figure 3.4), use the **Port** drop-down list to select the port to which the desired host is connected.
  - Drag the desired host bus adapter to the host group in the **LU Path** outline view (on the upper left of the LUN Manager tab; refer to Figure 3.2).
5. If the desired host is not connected to any port in the subsystem, take the following steps:
  - In the **LU Path** outline view (on the upper left of the LUN Manager tab; refer to Figure 3.2), right-click the host group and then select **Add New WWN** from the pop-up menu (see Figure 4.9) to open the Add New WWN panel (see Figure 4.10).
  - Click the arrow to the right of the **WWN** drop-down box of the Add New WWN panel and select the desired host bus adapter from the list. If the list does not include the desired host bus adapter, enter the desired WWN in the **WWN** drop-down box.
  - If desired, enter a name for the host bus adapter. **Note:** The name can be up to 8 alphanumeric characters and is case-sensitive. A name is not required, because the HBA is also identified by WWN, but it can be useful.
  - Select **OK**. The specified WWN and name appear below the selected host group.
6. If you want to apply the changes to the subsystem, select **Apply** and then select **OK** on the confirmation message (refer to Figure 4.7).
7. If you want to cancel the changes and not apply them to the subsystem, select **Cancel** and then select **OK** on the confirmation message (refer to Figure 4.8).

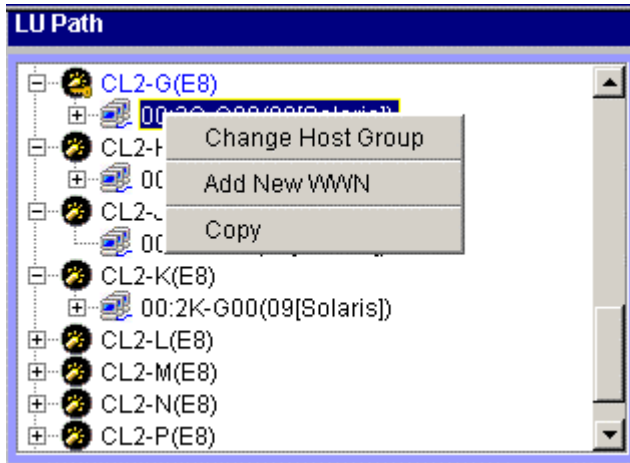

Figure 4.9 Add New WWN Pop-Up Menu

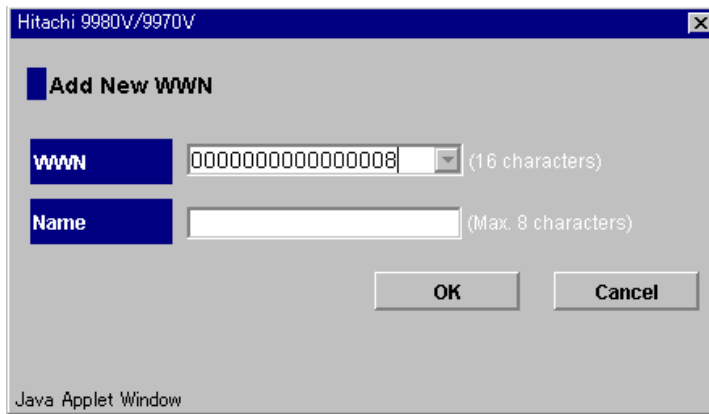



Figure 4.10 Add New WWN Panel

## 4.2.4 Associating Host Groups to Logical Volumes

LUN Manager allows you define LU paths by associating host groups with logical volumes. For example, if you associate a group of three hosts with logical volumes, LU paths are defined between the three hosts and the logical volumes.

To define LU paths:

1. Change to **Modify** mode (refer to section 2.3 if you need instructions).
2. Select the **LUN Manager/LUN Security** button (  ) on the Remote Console main panel (refer to Figure 2.1) to open the LUN Manager/Port panel. The **LUN Manager** tab is the default view (refer to Figure 3.1).
3. In the LU Path Outline detail (on the upper left of the panel; refer to Figure 3.2), select a host group, then select a CU number. The **LU Path** table (on the upper right of the panel; refer to Figure 3.3) will display LDEVs in the specified CU image.
4. Select one or more logical volumes in the **LDEV** detail (on the lower right of the panel; refer to Figure 3.5), then drag the volumes to the **LU Path** table (on the upper right of the panel; refer to Figure 3.3). Select one or more LUNs to which no LU path is defined (indicated by the  icon) and then release the mouse button.
5. Select **OK** on the confirmation message (see Figure 4.11) to confirm the changes, or select **Cancel** to cancel the changes. **Note:** The settings are reflected in the **LU Path** table, but not yet implemented.
6. If you want to apply the changes to the subsystem, select **Apply** and then select **OK** on the confirmation message (refer to Figure 4.7).
7. If you want to cancel the changes and not apply them to the subsystem, select **Cancel** and then select **OK** on the confirmation message (refer to Figure 4.8).

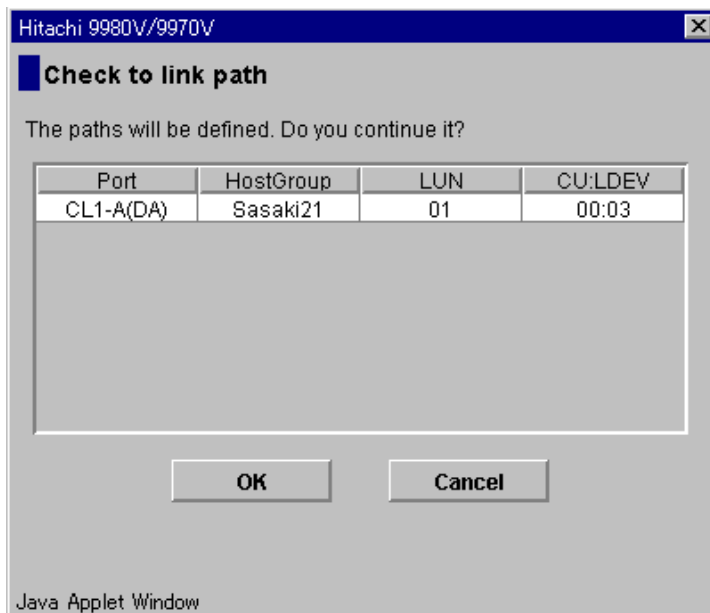

Figure 4.11 Link Path Confirmation Message

## 4.3 Changing the LU Path Settings

You can make the following changes to LU Path settings:

- Deleting LU paths (see section 4.3.1)
- Changing WWNs or names of host bus adapters (see section 4.3.2)
- Deleting WWNs (see section 4.3.3)
- Changing the host group name and the host mode (see section 4.3.4)
- Deleting host groups (see section 4.3.5)
- Defining alternate paths (see section 4.3.6)

### 4.3.1 Deleting LU Paths

**Caution:** Do not remove LU paths when host I/O is in progress.

To delete LU paths:

1. Change to **Modify** mode (refer to section 2.3 if you need instructions).
2. Select the **LUN Manager/LUN Security** button () on the Remote Console main panel (refer to Figure 2.1) to open the LUN Manager/Port panel. The **LUN Manager** tab is the default view (refer to Figure 3.1).
3. In the **LU Path** table (on the upper right of the panel; refer to Figure 3.3), select one or more LUNs to which volumes are assigned. **Note:** if volumes are assigned, the columns to the right of the **LUN** column will display data.
4. Right-click the selection and then select **Release LU Path** from the pop-up menu (see Figure 4.12).
5. Select **OK** on the confirmation message (see Figure 4.11) to confirm the changes, or select **Cancel** to cancel the changes. **Note:** The settings are reflected in the **LU Path** table, but not yet implemented.
6. If you want to apply the changes to the subsystem, select **Apply** and then select **OK** on the confirmation message (refer to Figure 4.7).
7. If you want to cancel the changes and not apply them to the subsystem, select **Cancel** and then select **OK** on the confirmation message (refer to Figure 4.8).

| LUN | CU:LDEV | Emulation  | Capacity | RAID     | Paths |
|-----|---------|------------|----------|----------|-------|
| 00  | 01:40   | OPEN-L * 1 | 33.94GB  | 1(2D+2D) | 1     |
| 01  | 01:41   | OPEN-L * 1 | 33.94GB  | 1(2D+2D) | 1     |
| 02  |         |            | 33.94GB  | 1(2D+2D) | 1     |
| 03  |         |            | 33.94GB  | 1(2D+2D) | 1     |
| 04  | 01:50   | OPEN-L * 1 | 33.94GB  | 1(2D+2D) | 1     |
| 05  | 01:51   | OPEN-L * 1 | 33.94GB  | 1(2D+2D) | 1     |
| 06  | 01:52   | OPEN-L * 1 | 33.94GB  | 1(2D+2D) | 1     |
| 07  | 01:53   | OPEN-L * 1 | 33.94GB  | 1(2D+2D) | 1     |
| 08  | 01:60   | OPEN-L * 1 | 33.94GB  | 1(2D+2D) | 1     |
| 09  | 01:61   | OPEN-L * 1 | 33.94GB  | 1(2D+2D) | 1     |

Selected LUNs:1      Remaining LUNs(Port):480      Remaining LUNs(GRP):224

Figure 4.12 Release LU Path Pop-Up Menu

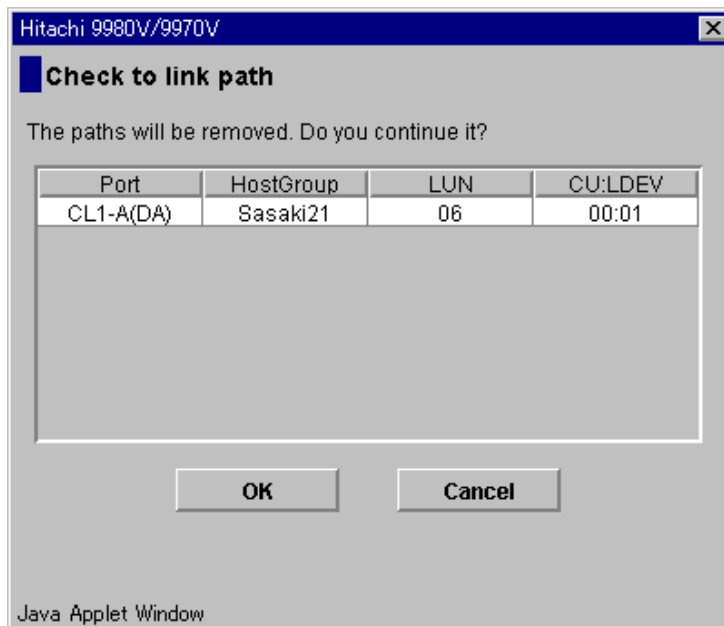



Figure 4.13 Release LU Path Confirmation Message

### 4.3.2 Changing WWNs and Names of Host Bus Adapters

To change the WWN and/or the name of a host bus adapter:

1. Change to **Modify** mode (refer to section 2.3 if you need instructions).
2. Select the **LUN Manager/LUN Security** button  on the Remote Console main panel (refer to Figure 2.1) to open the LUN Manager/Port panel. The **LUN Manager** tab is the default view (refer to Figure 3.1).
3. In the LU Path Outline detail (on the upper left of the panel; refer to Figure 3.2), verify that LUN security has been applied to the port you want to change. **Note:** If the icon has a key on it, LUN security has been applied. For instructions on how to apply and remove LUN security, see section 4.4.
4. In the LU Path Outline detail, select a port, then select and right-click a WWN.
5. Select **Change WWN & Nickname** from the pop-up menu to display the Change WWN & Name Panel (see Figure 4.14).
6. If you want to change the WWN, enter a new WWN or select another WWN in the **WWN** drop-down box.
7. If you want to change the name, enter a new name in the **Name** box.
8. Select **OK** on the confirmation message to confirm the changes, or select **Cancel** to cancel the changes. **Note:** The settings are reflected in the **LU Path** table, but not yet implemented.
9. If you want to apply the changes to the subsystem, select **Apply** and then select **OK** on the confirmation message (refer to Figure 4.7).
10. If you want to cancel the changes and not apply them to the subsystem, select **Cancel** and then select **OK** on the confirmation message (refer to Figure 4.8).

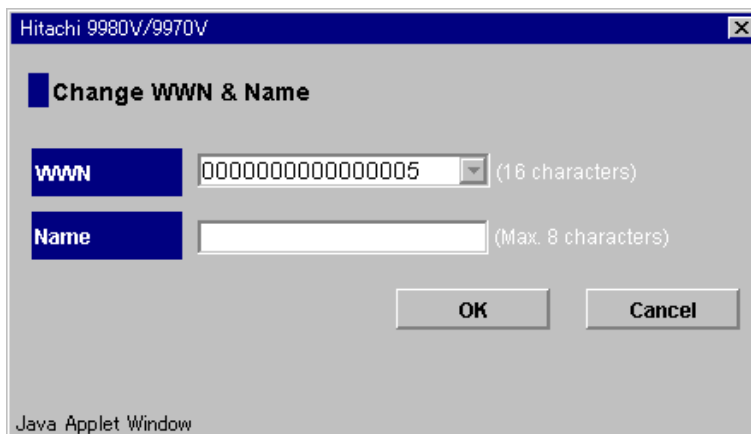



Figure 4.14 The Change WWN & Name Panel



### 4.3.3 Deleting WWNs

To delete a WWN:

1. Change to **Modify** mode (refer to section 2.3 if you need instructions).
2. Select the **LUN Manager/LUN Security** button () on the Remote Console main panel (refer to Figure 2.1) to open the LUN Manager/Port panel. The **LUN Manager** tab is the default view (refer to Figure 3.1).
3. In the LU Path Outline detail (on the upper left of the panel; refer to Figure 3.2), select and right-click a host group.
4. A pop-up menu appears. **Note:** If the WWN is grayed out, the pop-up menu will not appear. To be able to view the pop-up menu, verify that LUN security has been applied to the port you want to change. **Note:** If the icon has a key on it, LUN security has been applied. For instructions on how to apply and remove LUN security, see section 4.4.
5. Select **Delete WWN** from the pop-up menu.
6. Select **OK** on the confirmation message to confirm the changes, or select **Cancel** to cancel the changes. **Note:** The settings are reflected in the **LU Path** table, but not yet implemented.
7. If you want to apply the changes to the subsystem, select **Apply** and then select **OK** on the confirmation message (refer to Figure 4.7).
8. If you want to cancel the changes and not apply them to the subsystem, select **Cancel** and then select **OK** on the confirmation message (refer to Figure 4.8).

#### 4.3.4 Changing the Name and the Host Mode of a Host Group

**Warning:** Before changing the host mode of a host group, you should first back up data on the port to which the host group belongs. The operation for setting host mode operation should not be destructive, but data integrity cannot be guaranteed without a backup.

To change the name and/or the host mode of a host group:

1. Change to **Modify** mode (refer to section 2.3 if you need instructions).
2. Select the **LUN Manager/LUN Security** button () on the Remote Console main panel (refer to Figure 2.1) to open the LUN Manager/Port panel. The **LUN Manager** tab is the default view (refer to Figure 3.1).
3. In the LU Path Outline detail (on the upper left of the panel; refer to Figure 3.2), select then right-click a host group.
4. Select **Change Host Group** from the pop-up menu (see Figure 4.15) to display the Change Host Group Confirmation Message (see Figure 4.16).
5. If you want to change the name of the host group, enter a new name in the **Group Name** box.
6. If you want to change the host mode, select the new host mode from the **Host Mode** drop-down list.
7. Select **OK** on the Change Host Group panel to confirm the changes, or select **Cancel** to cancel the changes. **Note:** The settings are reflected in the **LU Path** table, but not yet implemented.
8. If you want to apply the changes to the subsystem, select **Apply** and then select **OK** on the confirmation message (refer to Figure 4.7).
9. If you want to cancel the changes and not apply them to the subsystem, select **Cancel** and then select **OK** on the confirmation message (refer to Figure 4.8).

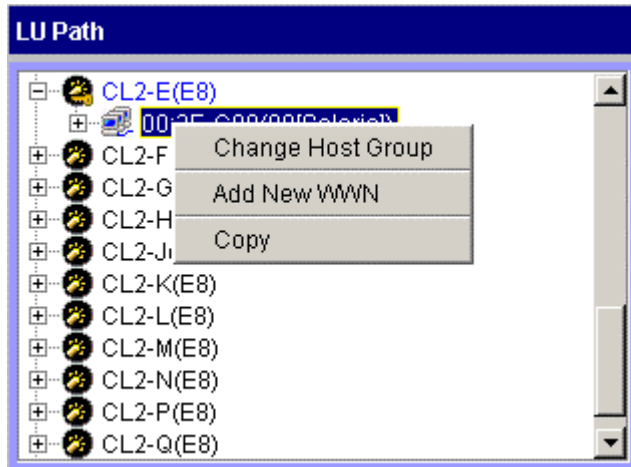

Figure 4.15 Change Host Group Pop-Up Menu

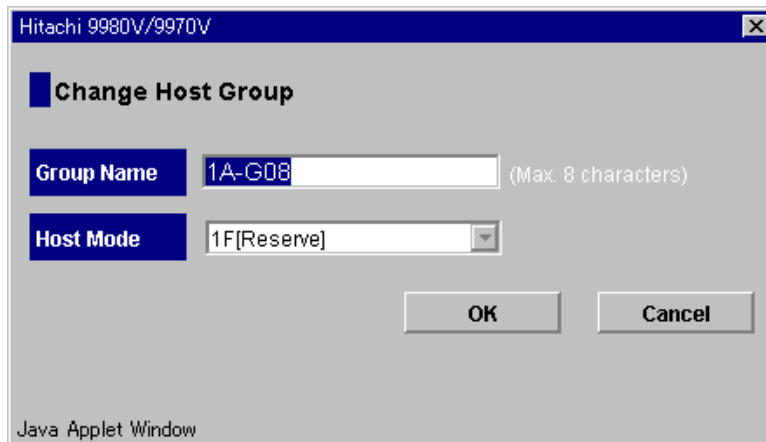



Figure 4.16 The Change Host Group Panel

### 4.3.5 Deleting Host Groups

**Caution:** Host group 0 (zero) cannot be deleted. If you want to remove all the WWNs and LU paths from host group 0, you must initialize the host group (see section 4.3.6).

To delete a host group:

1. Change to **Modify** mode (refer to section 2.3 if you need instructions).
2. Select the **LUN Manager/LUN Security** button () on the Remote Console main panel (refer to Figure 2.1) to open the LUN Manager/Port panel. The **LUN Manager** tab is the default view (refer to Figure 3.1).
3. In the LU Path Outline detail (on the upper left of the panel; refer to Figure 3.2), verify that LUN security has been applied to the port you want to change. **Note:** If the icon has a key on it, LUN security has been applied. For instructions on how to apply and remove LUN security, see section 4.4.
4. In the LU Path Outline detail, select and right-click the desired host group, then select **Delete Host Group** from the pop-up menu.
5. When the confirmation message displays do one of the following:
  - If you want to delete all the WWNs as well as the host group, select **Yes**.
  - If you want to delete the host group but do not want to delete the WWNs in the host group, select **No**. **Note:** The settings are reflected in the **LU Path** table, but not yet implemented.
6. If you want to apply the changes to the subsystem, select **Apply** and then select **OK** on the confirmation message (refer to Figure 4.7).
7. If you want to cancel the changes and not apply them to the subsystem, select **Cancel** and then select **OK** on the confirmation message (refer to Figure 4.8).

### 4.3.6 Initializing Host Group 0 (Zero)

Initializing host group zero (0) will remove all WWNs and LU paths and return the host group to its initial configuration. This procedure will also initialize the host group name, e.g., if you initialize host group 0 for the port CL1-A, the name of the host group 0 will revert to 1A-G00.

1. Change to **Modify** mode (refer to section 2.3 if you need instructions).
2. Select the **LUN Manager/LUN Security** button () on the Remote Console Main panel (refer to Figure 2.1) to open the LUN Manager/Port panel. The **LUN Manager** tab is the default view (refer to Figure 3.1).
3. In the LU Path Outline detail (on the upper left of the panel; refer to Figure 3.2), verify that LUN security has been applied to the port you want to change. **Note:** If the icon has a key on it, LUN security has been applied. For instructions on how to apply and remove LUN security, see section 4.4.
4. In the LU Path Outline detail, select and right-click the host group 0, which is preceded by the number 00.
5. Select **Clear Host Group** from the pop-up menu.
6. Select **Yes** to clear the contents of host group 0. Select **No** to cancel. **Note:** The settings are reflected in the **LU Path** table, but not yet implemented.
7. If you want to apply the changes to the subsystem, select **Apply** and then select **OK** on the confirmation message (refer to Figure 4.7).
8. If you want to cancel the changes and not apply them to the subsystem, select **Cancel** and then select **OK** on the confirmation message (refer to Figure 4.8).

### 4.3.7 Defining Alternate Paths

If you want to use alternate paths, you must copy LU paths from one port to another.

**Caution:** If you want to define alternate paths when LUN security is removed, you must re-define the LU path.

To define alternate paths:

1. Change to **Modify** mode (refer to section 2.3 if you need instructions).
2. Select the **LUN Manager/LUN Security** button (  ) on the Remote Console main panel (refer to Figure 2.1) to open the LUN Manager/Port panel. The **LUN Manager** tab is the default view (refer to Figure 3.1).
3. In the **LU Path** Outline detail (on the upper left of the panel; refer to Figure 3.2), select then right-click a host group then select **Copy** from the pop-up menu (see Figure 4.17)
4. Right-click a port that is not already associated with the host group, then select **Paste** from the pop-up menu.
5. The specified host group is copied to the specified port. The WWNs and the LU paths are also copied. **Note:** The settings are reflected in the **LU Path** Outline view, but not yet implemented.
6. If you want to apply the changes to the subsystem, select **Apply** and then select **OK** on the confirmation message (refer to Figure 4.7).
7. If you want to cancel the changes and not apply them to the subsystem, select **Cancel** and then select **OK** on the confirmation message (refer to Figure 4.8).

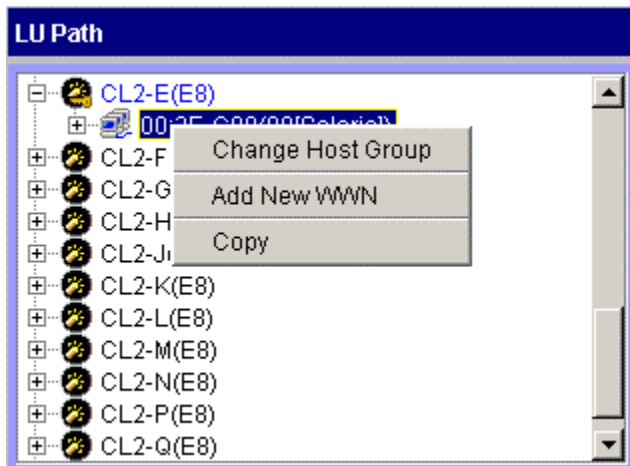











Figure 4.17 Copy Pop-Up Menu

## 4.4 Using LUN Security

LUN security allows you to secure LUs against unauthorized access. By default, LUN security is not applied to any of the fibre-channel ports.

### 4.4.1 Applying LUN Security

To apply LUN security to a port:

1. Change to **Modify** mode (refer to section 2.3 if you need instructions).
2. Select the **LUN Manager/LUN Security** button () on the Remote Console main panel (refer to Figure 2.1) to open the LUN Manager/Port panel. The **LUN Manager** tab is the default view (refer to Figure 3.1).
3. In the LU Path Outline detail (on the upper left of the panel; refer to Figure 3.2), locate the desired port. When you double-click the **Port** folder () an icon, the port name and the port address are displayed. The icon will be one of the following:
  -  indicates a short-wave port in **Standard** mode, with LUN security not applied.
  -  indicates a short-wave port in **Standard** mode. The addition of a key to the icon indicates that LUN security is applied to the port.
  -  indicates a long-wave port in **Standard** mode, with LUN security not applied.
  -  indicates a long-wave port in **Standard** mode. The addition of a key to the icon indicates that LUN security is applied to the port.
  -  indicates a short-wave port in **High-Speed** mode, with LUN security not applied.
  -  indicates a short-wave port in **High-Speed** mode. The addition of a key to the icon indicates that LUN security is applied to the port.
  -  indicates a long-wave port in **High-Speed** mode, with LUN security not applied.
  -  indicates a long-wave port in **High-Speed** mode. The addition of a key to the icon indicates that LUN security is applied to the port.
4. If LUN security has not been applied, select and right-click the port. Select **LUN Security: OFF -> ON** from the pop-up menu (see Figure 4.18).
5. A message appears, asking whether you want to change the LUN security setting (see Figure 4.19).
6. Select **YES**. The icon changes, but the changes are not yet applied to the subsystem.
7. If you want to apply the changes to the subsystem, select **Apply** and then select **OK** on the confirmation message (refer to Figure 4.7).
8. If you want to cancel the changes and not apply them to the subsystem, select **Cancel** and then select **OK** on the confirmation message (refer to Figure 4.8)

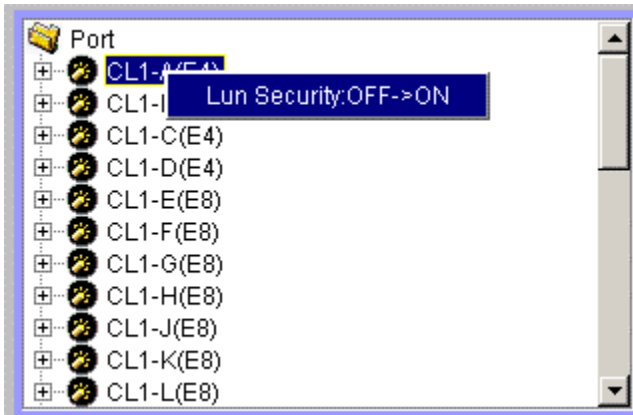

Figure 4.18 Add LUN Security Pop-Up Menu

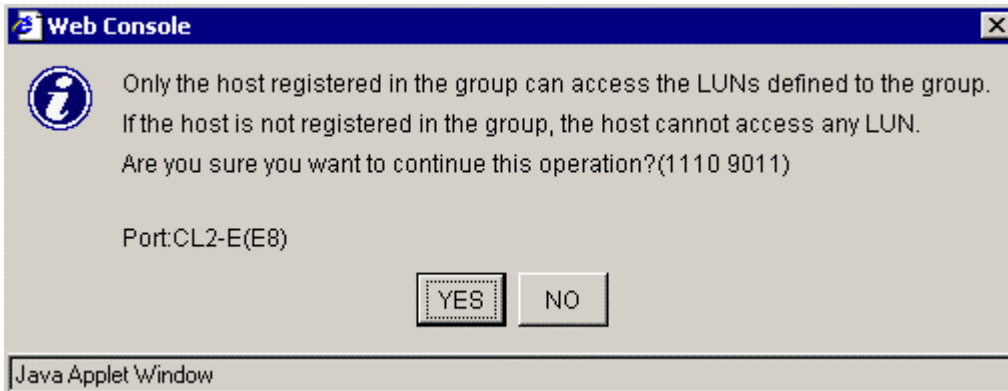











Figure 4.19 Add LUN Security Confirmation Message



## 4.4.2 Removing LUN Security

**Caution:** Do not remove LUN security from any port when host I/O is in progress.

To remove LUN security from a port:

1. Change to **Modify** mode (refer to section 2.3 if you need instructions).
2. Select the **LUN Manager/LUN Security** button () on the Remote Console main panel (refer to Figure 2.1) to open the LUN Manager/Port panel. The **LUN Manager** tab is the default view (refer to Figure 3.1).
3. In the LU Path Outline detail (on the upper left of the panel; refer to Figure 3.2), locate the desired port. When you double-click the **Port** folder () an icon, the port name and the port address are displayed. The icon will be one of the following:
  -  indicates a short-wave port in **Standard** mode, with LUN security not applied.
  -  indicates a short-wave port in **Standard** mode. The addition of a key to the icon indicates that LUN security is applied to the port.
  -  indicates a long-wave port in **Standard** mode, with LUN security not applied.
  -  indicates a long-wave port in **Standard** mode. The addition of a key to the icon indicates that LUN security is applied to the port.
  -  indicates a short-wave port in **High-Speed** mode, with LUN security not applied.
  -  indicates a short-wave port in **High-Speed** mode. The addition of a key to the icon indicates that LUN security is applied to the port.
  -  indicates a long-wave port in **High-Speed** mode, with LUN security not applied.
  -  indicates a long-wave port in **High-Speed** mode. The addition of a key to the icon indicates that LUN security is applied to the port.
4. If LUN security has been applied, select and right-click the port. Select **LUN Security: ON -> OFF** from the pop-up menu (see Figure 4.20).
5. A confirmation message appears, informing you that only host group 0 (group #00) will be available if LUN security is removed (see Figure 4.21). Select **YES** to close the message.
6. The icon will change to indicate that LUN security is not applied. The changes are not yet applied to the subsystem.
7. If you want to apply the changes to the subsystem, select **Apply** and then select **OK** on the confirmation message (refer to Figure 4.7).
8. If you want to cancel the changes and not apply them to the subsystem, select **Cancel** and then select **OK** on the confirmation message (refer to Figure 4.8).

**Note:** If LUN security is removed from a port, the host groups corresponding to that port except for the host group 0 are grayed out in the **LU Path** outline view (on the upper left of the LUN Manager tab; refer to Figure 3.2).

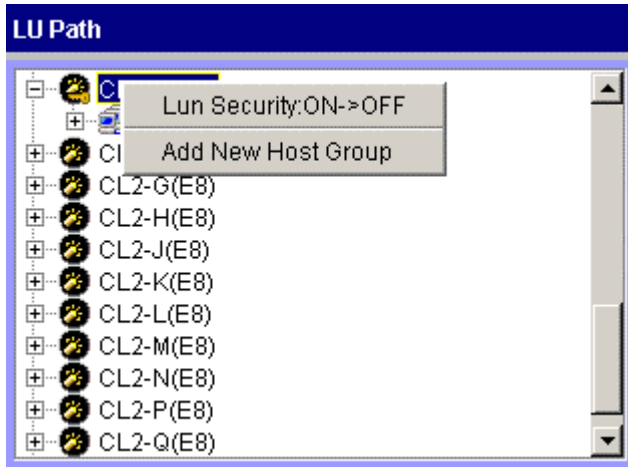

Figure 4.20 Delete LUN Security Pop-Up Menu

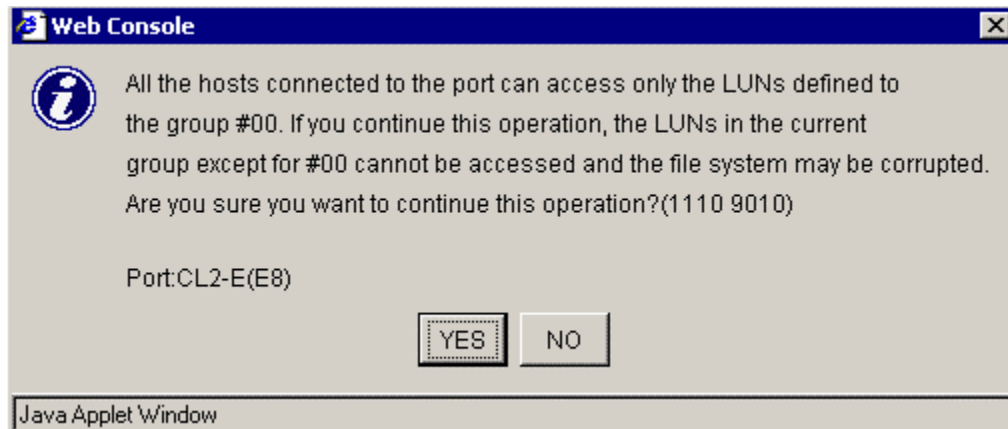

Figure 4.21 Delete LUN Security Confirmation Message

## 4.5 Configuring the Disk Subsystem for Using Command Control Interface (CCI)

### 4.5.1 Overview of Command Control Interface

Hitachi Command Control Interface (CCI) enables users to perform Hitachi TrueCopy and Hitachi ShadowImage operations on the Lightning 9900™ V Series subsystem by issuing commands from the UNIX®/PC server host to the 9900 V subsystem. The CCI software interfaces with the system software and high-availability (HA) software on the UNIX®/PC server host as well as the TrueCopy/ShadowImage software on the 9900 V subsystem. The CCI software provides failover and other functions such as backup commands to allow mutual hot standby in cooperation with the failover product on the UNIX®/PC server (e.g., MC/ServiceGuard®, FirstWatch®, HACMP).

CCI also supports a scripting function that allows users to define multiple TrueCopy and/or ShadowImage operations in a script (text) file. Using CCI scripting, you can set up and execute a large number of TrueCopy and/or ShadowImage commands in a short period of time while integrating host-based high-availability control over remote copy operations.

**Note:** For further information on CCI, please see the *Hitachi Lightning 9900™ V Series and Lightning 9900™ Command Control Interface (CCI) User and Reference Guide (MK-90RD011)*, or contact your Hitachi Data Systems account team.

If you want to protect a logical device from CCI commands, you must apply command device security to the logical device. If the command device security is applied to a logical device, the device will not be affected by CCI commands even when commands are transferred via a command device to that device.

**Note:** You cannot remove the last path from a command device.







**Warning:** You cannot use the following volumes as command devices:

- Volumes reserved by CruiseControl
- TrueCopy volumes
- ShadowImage volumes
- Volumes to which no LU paths are defined from hosts .

## 4.5.2 Specifying Logical Devices as Command Devices

To enable the system administrator to execute CCI commands from an open-system host, you must select at least one logical device that will not be manipulated by TrueCopy or ShadowImage, and then specify that device as a command device. CCI commands are issued from a host and received by the command device, which in turn transfers the command to another logical device and causes a TrueCopy or ShadowImage operation to be performed on that logical device.

To specify a logical device as a command device:

1. Change to **Modify** mode (refer to section 2.3 if you need instructions).
2. Select the **LUN Manager/LUN Security** button () on the Remote Console main panel (refer to Figure 2.1) to open the LUN Manager/Port panel. The **LUN Manager** tab is the default view (refer to Figure 3.1).
3. In the **LU Path** Outline detail (on the upper left of the panel; refer to Figure 3.2), double-click a port, then select a host group.
4. The **LU Path** table (on the upper right of the panel; refer to Figure 3.3) displays information about LU paths corresponding to the host group.
5. In the **LU Path** table, select and right-click a LUN that corresponds to the desired logical device. The **LUN** column will include some or all of the following icons:
  -  indicates a logical volume to which an LU path is defined.
  -  indicates an expanded LU.
  -  indicates a command device.
  -  indicates a secured command device.
  -  indicates a LUN to which no LU path is defined.
6. In the **LU Path** table, select and right-click a LUN that is not currently a command device. From the pop-up menu, select **Command Device: OFF -> ON** (see Figure 4.22).
7. A message appears, asking whether you want to use the logical device as a command device (see Figure 4.23).
8. Select **Yes**. **Note:** The icon changes to indicate a command device, but the changes are not yet applied to the subsystem.
9. If you want to apply the changes to the subsystem, select **Apply** and then select **OK** on the confirmation message (refer to Figure 4.7).
10. If you want to cancel the changes and not apply them to the subsystem, select **Cancel** and then select **OK** on the confirmation message (refer to Figure 4.8).

| LUN | CU:LDEV | Emulation  | Capacity | RAID     | Paths |
|-----|---------|------------|----------|----------|-------|
| 00  | 01:40   | OPEN-L * 1 | 33.94GB  | 1(2D+2D) | 1     |
| 01  |         |            | 3.94GB   | 1(2D+2D) | 1     |
| 02  |         |            | 3.94GB   | 1(2D+2D) | 1     |
| 03  | 01:43   | OPEN-L * 1 | 33.94GB  | 1(2D+2D) | 1     |
| 04  | 01:50   | OPEN-L * 1 | 33.94GB  | 1(2D+2D) | 1     |
| 05  | 01:51   | OPEN-L * 1 | 33.94GB  | 1(2D+2D) | 1     |
| 06  | 01:52   | OPEN-L * 1 | 33.94GB  | 1(2D+2D) | 1     |
| 07  | 01:53   | OPEN-L * 1 | 33.94GB  | 1(2D+2D) | 1     |
| 08  | 01:60   | OPEN-L * 1 | 33.94GB  | 1(2D+2D) | 1     |
| 09  | 01:61   | OPEN-L * 1 | 33.94GB  | 1(2D+2D) | 1     |

Selected LUNs:1      Remaining LUNs(Port):480      Remaining LUNs(GRP):224

Figure 4.22 Add Command Device Pop-Up Menu

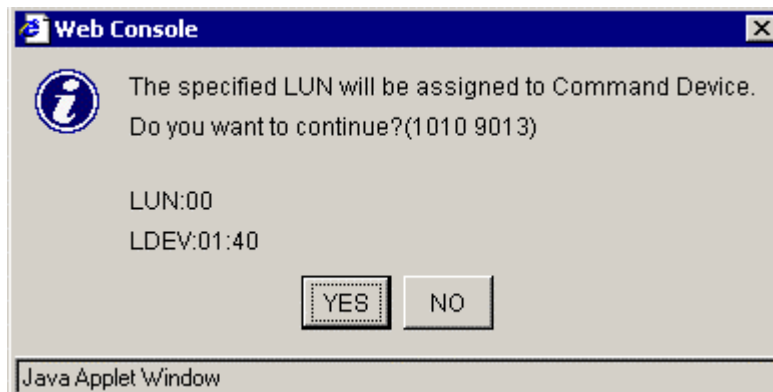







Figure 4.23 Assign Command Device Confirmation Message

### 4.5.3 Deleting a Command Device

1. Change to **Modify** mode (refer to section 2.3 if you need instructions).
2. Select the **LUN Manager/LUN Security** button () on the Remote Console main panel (refer to Figure 2.1) to open the LUN Manager/Port panel. The **LUN Manager** tab is the default view (refer to Figure 3.1).
3. In the **LU Path** Outline detail (on the upper left of the panel; refer to Figure 3.2), double-click a port, then select a host group.
4. The **LU Path** table (on the upper right of the panel; refer to Figure 3.3) displays information about LU paths corresponding to the host group.
5. In the **LU Path** table, select and right-click a LUN that corresponds to the desired logical device. The **LUN** column will include some or all of the following icons:
  -  indicates a logical volume to which an LU path is defined.
  -  indicates an expanded LU.
  -  indicates a command device.
  -  indicates a secured command device.
  -  indicates a LUN to which no LU path is defined.
6. In the **LU Path** table, select and right-click a LUN that is currently a command device. From the pop-up menu, select **Command Device: ON -> OFF** (see Figure 4.24).
7. A message appears, asking whether you want to release the command device attribute for this LUN (see Figure 4.25).
8. Select **Yes**. **Note:** The icon changes, to indicate that the LUN is not a command device, but the changes are not yet applied to the subsystem.
9. If you want to apply the changes to the subsystem, select **Apply** and then select **OK** on the confirmation message (refer to Figure 4.7).
10. If you want to cancel the changes and not apply them to the subsystem, select **Cancel** and then select **OK** on the confirmation message (refer to Figure 4.8).

| LUN                       | CU:LDEV | Emulation  | Capacity | RAID     | Paths |
|---------------------------|---------|------------|----------|----------|-------|
| 00                        | 01:40   | OPEN-L * 1 | 33.94GB  | 1(2D+2D) | 1     |
| Command Device:ON->OFF    |         |            | 33.94GB  | 1(2D+2D) | 1     |
| Cmd Dev. Security:OFF->ON |         |            | 33.94GB  | 1(2D+2D) | 1     |
| Release LU Path           |         |            | 33.94GB  | 1(2D+2D) | 1     |
| 05                        | 01:51   | OPEN-L * 1 | 33.94GB  | 1(2D+2D) | 1     |
| 06                        | 01:52   | OPEN-L * 1 | 33.94GB  | 1(2D+2D) | 1     |
| 07                        | 01:53   | OPEN-L * 1 | 33.94GB  | 1(2D+2D) | 1     |
| 08                        | 01:60   | OPEN-L * 1 | 33.94GB  | 1(2D+2D) | 1     |
| 09                        | 01:61   | OPEN-L * 1 | 33.94GB  | 1(2D+2D) | 1     |

Selected LUNs:2      Remaining LUNs(Port):480      Remaining LUNs(GRP):224

Figure 4.24 Release Command Device Pop-Up Menu (ON ->OFF)

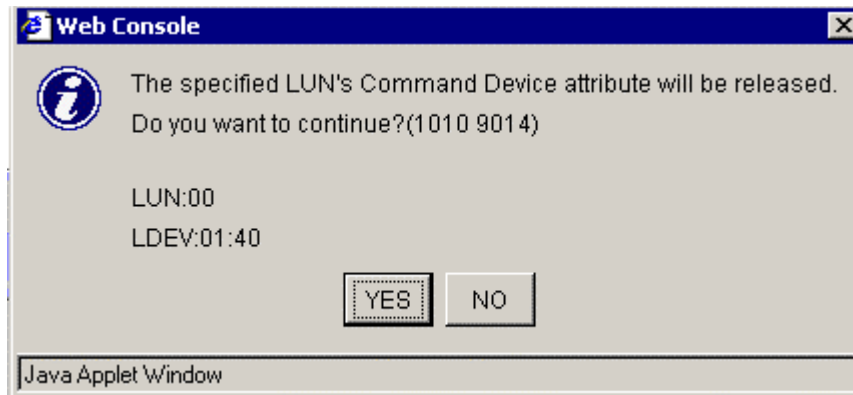







Figure 4.25 Release Command Device Confirmation Message

## 4.5.4 Enabling Command Device Security

If you want to protect logical volumes from CCI commands, you must apply command device security to the logical volumes. If command device security is applied to a logical device, the logical device will not be affected by CCI commands issued via command devices from the hosts.

To apply command device security to a logical device:

1. Change to **Modify** mode (refer to section 2.3 if you need instructions).
2. Select the **LUN Manager/LUN Security** button () on the Remote Console main panel (refer to Figure 2.1) to open the LUN Manager/Port panel. The **LUN Manager** tab is the default view (refer to Figure 3.1).
3. In the LU Path Outline detail (on the upper left of the panel; refer to Figure 3.2), double-click a port, then select a host group.
4. The **LU Path** table (on the upper right of the panel; refer to Figure 3.3) displays information about LU paths corresponding to the host group.
5. In the **LU Path** table, select and right-click a LUN that corresponds to the desired logical device. The **LUN** column will include some or all of the following icons:
  -  indicates a logical volume to which an LU path is defined.
  -  indicates an expanded LU.
  -  indicates a command device.
  -  indicates a secured command device.
  -  indicates a LUN to which no LU path is defined.
6. In the **LU Path** table, select and right-click an LUN that corresponds to the desired logical device. Select **Cmd. Dev. Security: OFF -> ON** from the pop-up menu (see Figure 4.26). A message appears, asking whether you want to apply command device security (see Figure 4.27).
7. Select **Yes**. A key will be added to the icon, indicating a secured command device, but the changes are not yet applied to the subsystem.
8. If you want to apply the changes to the subsystem, select **Apply** and then select **OK** on the confirmation message (refer to Figure 4.7).
9. If you want to cancel the changes and not apply them to the subsystem, select **Cancel** and then select **OK** on the confirmation message (refer to Figure 4.8).



| LUN | CU:LDEV | Emulation                 | Capacity | RAID     | Paths |
|-----|---------|---------------------------|----------|----------|-------|
| 00  | 01:40   | OPEN-L * 1                | 33.94GB  | 1(2D+2D) | 1     |
| 00  |         | Command Device:ON->OFF    | 33.94GB  | 1(2D+2D) | 1     |
| 00  |         | Cmd Dev. Security:OFF->ON | 33.94GB  | 1(2D+2D) | 1     |
| 00  |         | Release LU Path           | 33.94GB  | 1(2D+2D) | 1     |
| 05  | 01:51   | OPEN-L * 1                | 33.94GB  | 1(2D+2D) | 1     |
| 06  | 01:52   | OPEN-L * 1                | 33.94GB  | 1(2D+2D) | 1     |
| 07  | 01:53   | OPEN-L * 1                | 33.94GB  | 1(2D+2D) | 1     |
| 08  | 01:60   | OPEN-L * 1                | 33.94GB  | 1(2D+2D) | 1     |
| 09  | 01:61   | OPEN-L * 1                | 33.94GB  | 1(2D+2D) | 1     |

Selected LUNs:2      Remaining LUNs(Port):480      Remaining LUNs(GRP):224

Figure 4.26 Add Command Device Security Pop-Up Menu

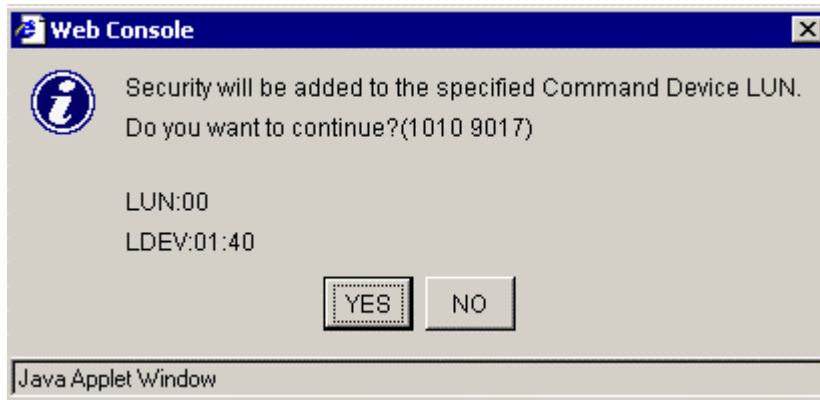







Figure 4.27 Add Command Device Security Confirmation Menu

## 4.5.5 Removing Command Device Security

To remove command device security to a logical device:

1. Change to **Modify** mode (refer to section 2.3 if you need instructions).
2. Select the **LUN Manager/LUN Security** button () on the Remote Console main panel (refer to Figure 2.1) to open the LUN Manager/Port panel. The **LUN Manager** tab is the default view (refer to Figure 3.1).
3. In the LU Path Outline detail (on the upper left of the panel; refer to Figure 3.2), double-click a port, then select a host group.
4. The **LU Path** table (on the upper right of the panel; refer to Figure 3.3) displays information about LU paths corresponding to the host group.
5. In the **LU Path** table, select and right-click a LUN that corresponds to the desired logical device. The **LUN** column will include some or all of the following icons:
  -  indicates a logical volume to which an LU path is defined.
  -  indicates an expanded LU.
  -  indicates a command device.
  -  indicates a secured command device.
  -  indicates a LUN to which no LU path is defined.
6. In the **LU Path** table, select and right-click an LUN that corresponds to the desired logical device. Select **Cmd. Dev. Security: ON -> OFF** from the pop-up menu (see Figure 4.28).
7. A message appears, asking whether you want to apply command device security (see Figure 4.29).
8. Select **Yes**. The icon changes to indicate that command device security is no longer applied, but the changes are not yet applied to the subsystem.
9. If you want to apply the changes to the subsystem, select **Apply** and then select **OK** on the confirmation message (refer to Figure 4.7).
10. If you want to cancel the changes and not apply them to the subsystem, select **Cancel** and then select **OK** on the confirmation message (refer to Figure 4.8).

| LUN | CU:LDEV | Emulation                 | Capacity | RAID     | Paths |
|-----|---------|---------------------------|----------|----------|-------|
| 00  | 01:40   | OPEN-L * 1                | 33.94GB  | 1(2D+2D) | 1     |
|     |         | Command Device:ON->OFF    | 33.94GB  | 1(2D+2D) | 1     |
|     |         | Cmd Dev. Security:ON->OFF | 33.94GB  | 1(2D+2D) | 1     |
|     |         | Release LU Path           | 33.94GB  | 1(2D+2D) | 1     |
| 05  | 01:51   | OPEN-L * 1                | 33.94GB  | 1(2D+2D) | 1     |
| 06  | 01:52   | OPEN-L * 1                | 33.94GB  | 1(2D+2D) | 1     |
| 07  | 01:53   | OPEN-L * 1                | 33.94GB  | 1(2D+2D) | 1     |
| 08  | 01:60   | OPEN-L * 1                | 33.94GB  | 1(2D+2D) | 1     |
| 09  | 01:61   | OPEN-L * 1                | 33.94GB  | 1(2D+2D) | 1     |

Selected LUNs:1      Remaining LUNs(Port):480      Remaining LUNs(GRP):224

Figure 4.28 Release Command Device Security Pop-Up Menu

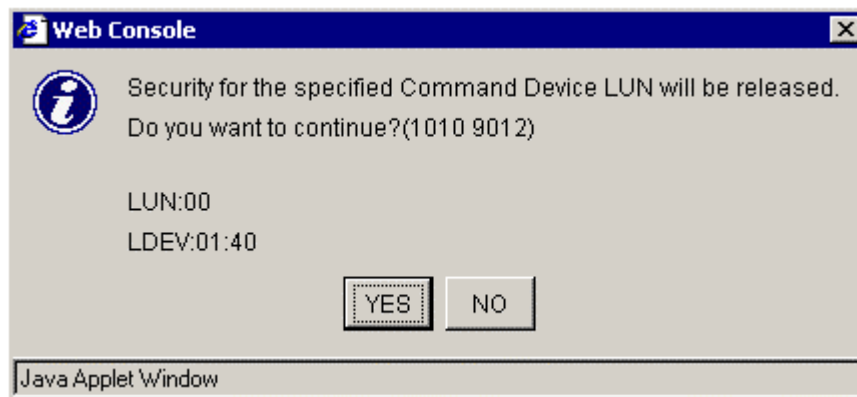

Figure 4.29 Release Command Device Security Confirmation Message

## 4.6 Configuring Fibre-Channel Ports

To configure a subsystem, complete the following steps:

- Set the host speed for fibre-channel ports (see section 4.6.1),
- Address the fibre-channel ports (see section 4.6.2),
- Set the fibre-channel topology (see section 4.6.3)
- Set the port for either standard or high-speed mode (see section 4.6.4).

### 4.6.1 Setting Host Speed for Fibre-Channel Ports

As the system operation continues, you might notice that a larger amount of data is transferred at some ports but a smaller amount of data is transferred at some other ports. If you set a faster data transfer speed to ports where a larger amount of data is transferred, you will be able to optimize the performance of your system. If you set a slower data transfer speed to port where a smaller amount of data is transferred, you will also be able to optimize the performance.

You can adjust the data transfer speed for fibre-channel ports so that the system performance is optimized. For details, see section 4.6.1.

To specify the data transfer speed for a fibre-channel port:

1. Change to **Modify** mode. Refer to section 2.3 if you need instructions.
2. Select the **LUN Manager/LUN Security** button () on the Remote Console main panel (refer to Figure 2.1) to open the LUN Manager/Port panel. The **LUN Manager** tab is the default view (refer to Figure 3.1). Select the **Port** tab (refer to Figure 3.6).
3. In the **Package** outline view (on the upper left corner of the panel; refer to Figure 3.7), select the **All** folder. The **Port** table (on the upper right corner of the panel; refer to Figure 3.8) displays a list of ports in the disk subsystem. **Note:** If you specify a channel adapter in the **Package** outline view, the **Port** table displays only the ports in the specified channel adapter.
4. Select a port from the **Port** table or the **Select a Port** drop-down list. The **Change Port Mode** box (on the lower right of the panel; see Figure 3.9) displays information about the selected ports.
5. Select the desired data transfer speed from the **Host Speed** drop-down list in the **Mode** area (see Figure 4.30), then select **Set**.
6. Select **OK** on the Change Port Mode confirmation message (refer to Figure 4.35) to update the setting, or select **Cancel** to cancel the setting. **Important:** these changes are not yet implemented in the disk subsystem.
7. If you want to apply the changes to the subsystem, select **Apply** and then select **OK** on the confirmation message (refer to Figure 4.7).
8. If you want to cancel the changes and not apply them to the subsystem, select **Cancel** and then select **OK** on the confirmation message (refer to Figure 4.8).

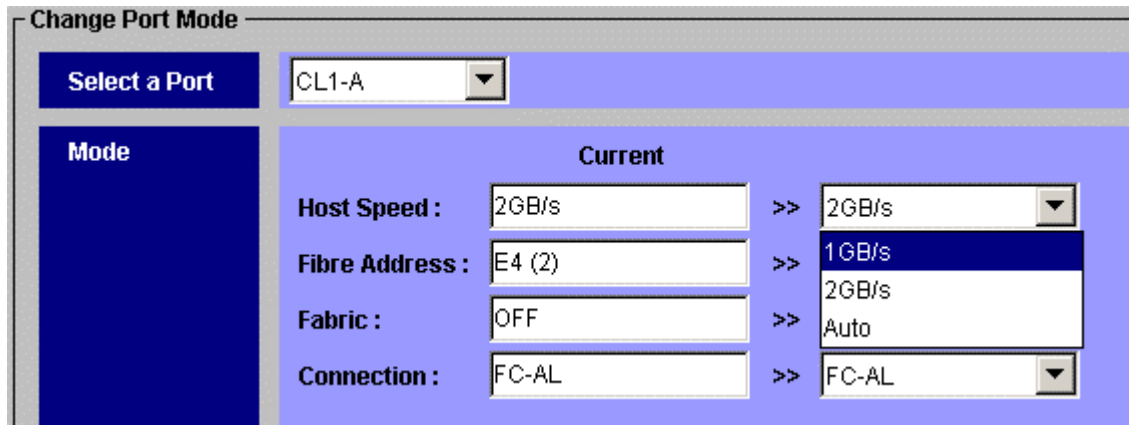



Figure 4.30 Host Speed Drop-Down Box

## 4.6.2 Addressing Fibre-Channel Ports

To set the address of a fibre-channel port:

1. Change to **Modify** mode. Refer to section 2.3 if you need instructions.
2. Select the **LUN Manager/LUN Security** button  on the Remote Console main panel (refer to Figure 2.1) to open the LUN Manager/Port panel. The **LUN Manager** tab is the default view (refer to Figure 3.1). Select the **Port** tab (refer to Figure 3.6).
3. In the **Package** outline view (on the upper left corner of the panel; refer to Figure 3.7), select the **All** folder. The **Port** table (on the upper right corner of the panel; refer to Figure 3.8) displays a list of ports in the disk subsystem. **Note:** If you specify a channel adapter in the **Package** outline view, the **Port** table displays only the ports in the specified channel adapter.
4. Select a port from the **Port** table or the **Select a Port** drop-down list. The **Change Port Mode** box (on the lower right of the panel; see Figure 3.9) displays information about the selected ports.
5. Select an address from the **Fibre Address** drop-down list (see Figure 4.31), then select **Set**. Table 4.2 displays the available addresses for fibre-channel ports.
6. Select **OK** on the Change Port Mode confirmation message (refer to Figure 4.35 to update the setting, or select **Cancel** to cancel the setting. **Important:** these changes are not yet implemented in the disk subsystem.
7. If you want to apply the changes to the subsystem, select **Apply** and then select **OK** on the confirmation message (refer to Figure 4.7).
8. If you want to cancel the changes and not apply them to the subsystem, select **Cancel** and then select **OK** on the confirmation message (refer to Figure 4.8).

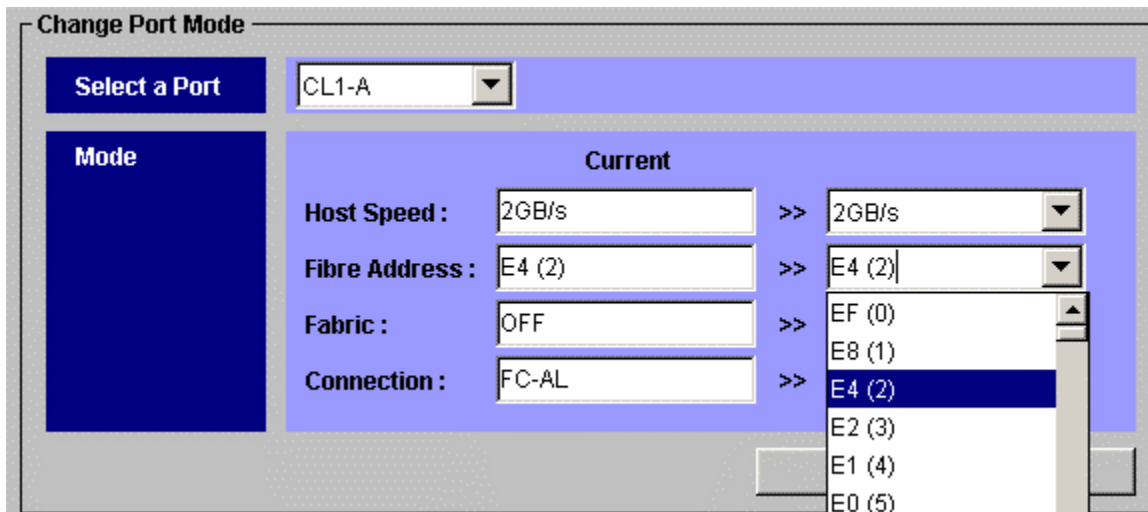

Figure 4.31 Fibre-Address Drop-Down Box

**Table 4.2 Available Addresses for Fibre-Channel Ports**

| Port Address (AL-PA) | Loop ID | Port Address (AL-PA) | Loop ID | Port Address (AL-PA) | Loop ID | Port Address (AL-PA) | Loop ID | Port Address (AL-PA) | Loop ID |
|----------------------|---------|----------------------|---------|----------------------|---------|----------------------|---------|----------------------|---------|
| EF                   | 0       | B4                   | 30      | 76                   | 60      | 49                   | 90      | 10                   | 120     |
| E8                   | 1       | B3                   | 31      | 75                   | 61      | 47                   | 91      | 0F                   | 121     |
| E4                   | 2       | B2                   | 32      | 74                   | 62      | 46                   | 92      | 08                   | 122     |
| E2                   | 3       | B1                   | 33      | 73                   | 63      | 45                   | 93      | 04                   | 123     |
| E1                   | 4       | AE                   | 34      | 72                   | 64      | 43                   | 94      | 02                   | 124     |
| E0                   | 5       | AD                   | 35      | 71                   | 65      | 3C                   | 95      | 01                   | 125     |
| DC                   | 6       | AC                   | 36      | 6E                   | 66      | 3A                   | 96      |                      |         |
| DA                   | 7       | AB                   | 37      | 6D                   | 67      | 39                   | 97      |                      |         |
| D9                   | 8       | AA                   | 38      | 6C                   | 68      | 36                   | 98      |                      |         |
| D6                   | 9       | A9                   | 39      | 6B                   | 69      | 35                   | 99      |                      |         |
| D5                   | 10      | A7                   | 40      | 6A                   | 70      | 34                   | 100     |                      |         |
| D4                   | 11      | A6                   | 41      | 69                   | 71      | 33                   | 101     |                      |         |
| D3                   | 12      | A5                   | 42      | 67                   | 72      | 32                   | 102     |                      |         |
| D2                   | 13      | A3                   | 43      | 66                   | 73      | 31                   | 103     |                      |         |
| D1                   | 14      | 9F                   | 44      | 65                   | 74      | 2E                   | 104     |                      |         |
| CE                   | 15      | 9E                   | 45      | 63                   | 75      | 2D                   | 105     |                      |         |
| CD                   | 16      | 9D                   | 46      | 5C                   | 76      | 2C                   | 106     |                      |         |
| CC                   | 17      | 9B                   | 47      | 5A                   | 77      | 2B                   | 107     |                      |         |
| CB                   | 18      | 98                   | 48      | 59                   | 78      | 2A                   | 108     |                      |         |
| CA                   | 19      | 97                   | 49      | 56                   | 79      | 29                   | 109     |                      |         |
| C9                   | 20      | 90                   | 50      | 55                   | 80      | 27                   | 110     |                      |         |
| C7                   | 21      | 8F                   | 51      | 54                   | 81      | 26                   | 111     |                      |         |
| C6                   | 22      | 88                   | 52      | 53                   | 82      | 25                   | 112     |                      |         |
| C5                   | 23      | 84                   | 53      | 52                   | 83      | 23                   | 113     |                      |         |
| C3                   | 24      | 82                   | 54      | 51                   | 84      | 1F                   | 114     |                      |         |
| BC                   | 25      | 81                   | 55      | 4E                   | 85      | 1E                   | 115     |                      |         |
| BA                   | 26      | 80                   | 56      | 4D                   | 86      | 1D                   | 116     |                      |         |
| B9                   | 27      | 7C                   | 57      | 4C                   | 87      | 1B                   | 117     |                      |         |
| B6                   | 28      | 7A                   | 58      | 4B                   | 88      | 18                   | 118     |                      |         |
| B5                   | 29      | 79                   | 59      | 4A                   | 89      | 17                   | 119     |                      |         |

### 4.6.3 Setting the Fibre-Channel Topology

The available topology types are as follows:

- **Fabric:** Utilizes a fabric switch to connect a large number of devices (up to 16 million) together. Each device will have the full bandwidth of 100 MB/s.
- **FC-AL (Fibre-Channel-Arbitrated Loop):** A shared interface that can connect up to 126 devices (AL-ports) together. The 100 MB/s bandwidth is shared among the devices connected to each other (see Figure 4.32).
- **Point-to-Point:** The simplest fibre topology connects two devices directly together.

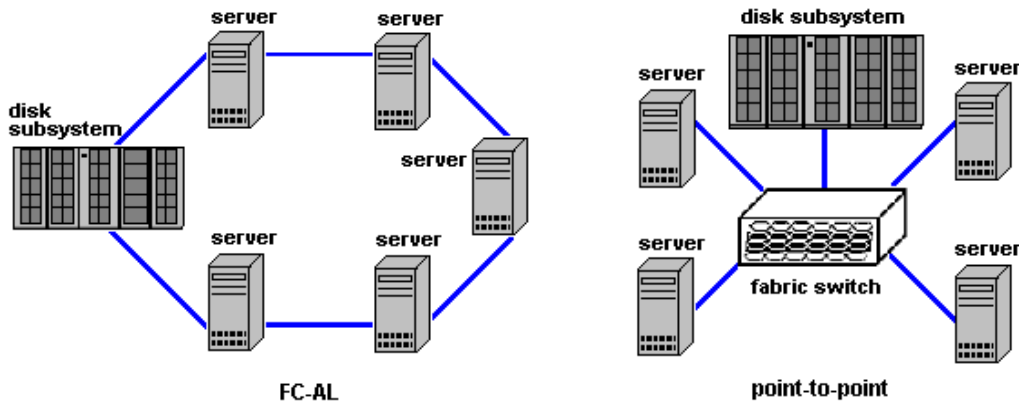

Figure 4.32 Illustration of FC-AL and Point-to-Point Topology

When you configure your system, you must specify whether the hosts and the disk subsystem are connected via a fabric switch.

If a fabric switch is used, you must specify FC-AL or Point-to-Point (FC-AL is the default). If a fabric switch is used, you must consult the documentation for the fabric switch to learn whether FC-AL or Point-to-Point should be used. Some fabric switches require you to specify Point-to-Point to get the system running.

If no fabric switch is used, you must specify FC-AL.



### To specify the topology:

1. Change to **Modify** mode. Refer to section 2.3 if you need instructions.
2. Select the **LUN Manager/LUN Security** button () on the Remote Console main panel (refer to Figure 2.1) to open the LUN Manager/Port panel. The **LUN Manager** tab is the default view (refer to Figure 3.1). Select the **Port** tab (refer to Figure 3.6).
3. In the **Package** outline view (on the upper left corner of the panel; refer to Figure 3.7), select the **All** folder. The **Port** table (on the upper right corner of the panel; refer to Figure 3.8) displays a list of ports in the disk subsystem. **Note:** If you specify a channel adapter in the **Package** outline view, the **Port** table displays only the ports in the specified channel adapter.
4. Select a port from the **Port** table or the **Select a Port** drop-down list. The **Change Port Mode** box (on the lower right of the panel; refer to Figure 3.9) displays information about the selected ports.
5. If a fabric switch is used, select **ON** from the **Fabric** drop-down list in the **Change Port Mode** box (see Figure 4.33). If a fabric switch is not used, select **OFF** from the **Fabric** drop-down list.
6. Select **FC-AL** or **P-to P (Point-to-Point)** from the **Connection** drop-down list (see Figure 4.34). **Note:** If a fabric switch is used, you must consult the documentation for the fabric switch to verify whether you need Point-to-Point topology.
7. Select **Set**.
8. Select **OK** on the **Change Port Mode** confirmation message (see Figure 4.35) to update the setting, or select **Cancel** to cancel the setting. **Important:** these changes are not yet implemented in the disk subsystem.
1. If you want to apply the changes to the subsystem, select **Apply** and then select **OK** on the confirmation message (refer to Figure 4.7).
2. If you want to cancel the changes and not apply them to the subsystem, select **Cancel** and then select **OK** on the confirmation message (refer to Figure 4.8).

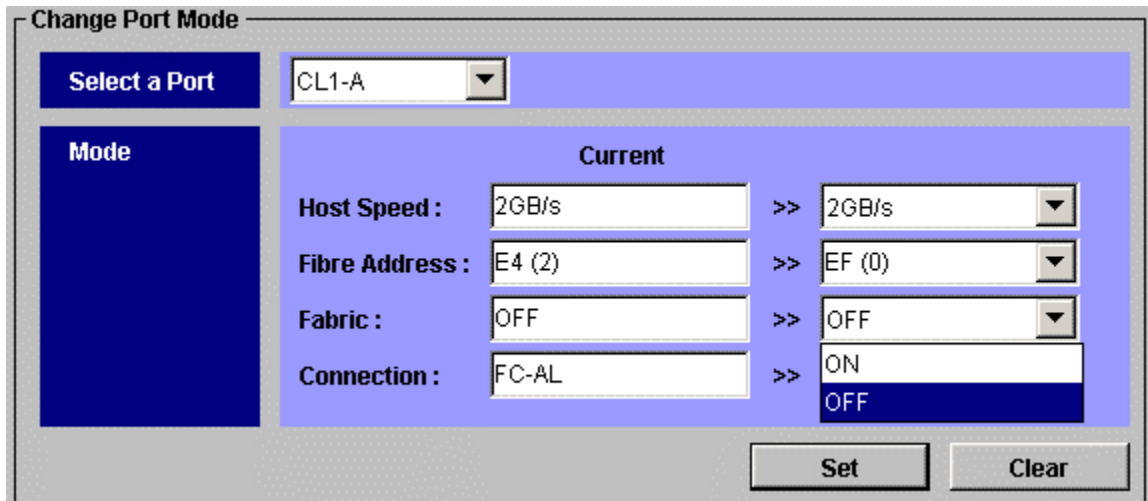

Figure 4.33 Fabric On-Off Drop-Down Box

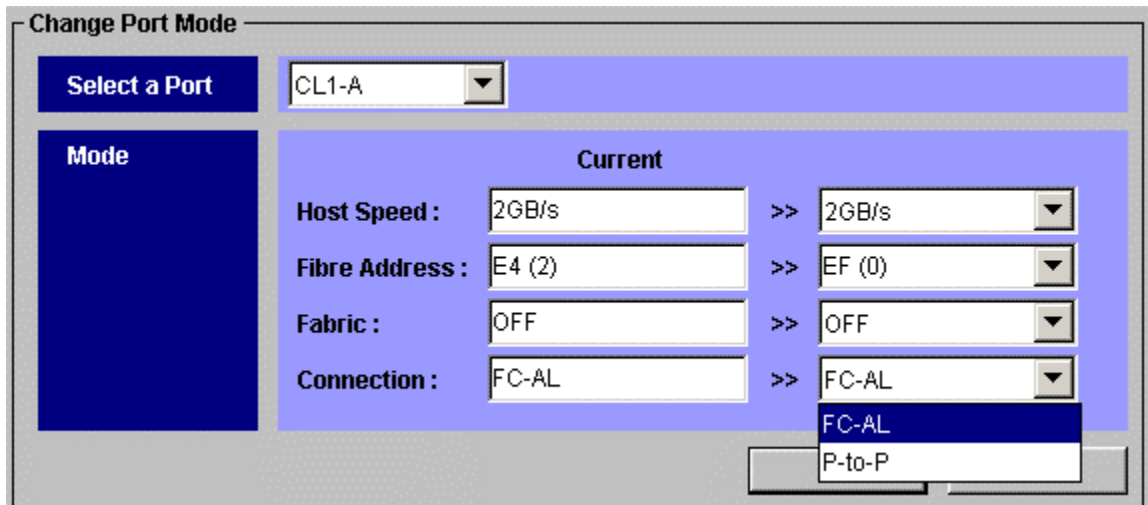

Figure 4.34 Connection Drop-Down Box



Figure 4.35 Change Port Mode Confirmation Message

## 4.6.4 Changing the Fibre PCB Mode Between Standard and High-speed Mode

**Warning:** If you want to change the configuration of a port that is being used, back up your data before changing the port configuration.

**Note:** You cannot change the fibre PCB mode while you are online to the host. You will need to reboot the host after changing the mode.

In high-speed mode, you will only use one of the four ports, which uses the channel processors and fibre optic processors (FOPs) that would otherwise be reserved for the other three ports. By default, all the channel adapter boards are in standard mode. High-speed mode has the following requirements:

- You are only planning to use one of the four ports.
- Each port has the same Fibre topology option (**On** or **Off**).
- Each port has **FC-AL** as the Connection option.
- Each port uses different port addresses.
- Each port has the same port type (**Initiator**, **RCU target**, or **Target**).

To change between standard mode and high-speed mode:





1. Change to **Modify** mode. Refer to section 2.3 if you need instructions.
2. Select the **LUN Manager/LUN Security** button () on the Remote Console main panel (refer to Figure 2.1) to open the LUN Manager/Port panel. The **LUN Manager** tab is the default view (refer to Figure 3.1). Select the **Port** tab (refer to Figure 3.6).
3. In the **Package** outline view (on the upper left corner of the panel; refer to Figure 3.7), select the **All** folder. The outline view displays a list of CHA (channel adapter) packages. The icon will be one of the following:
  -  indicates a short-wave CHA package in standard mode
  -  indicates a long-wave CHA package in standard mode
  -  indicates a short-wave CHA package in high-speed mode
  -  indicates a long-wave CHA package in high-speed mode
4. In the **Package** outline view, select and right-click a channel adapter (CHA) package.
5. Select the desired mode from the pop-up menu.
  - If the current mode is standard, the **Standard mode** option is preceded by a dot.
  - If the current mode is high-speed, the **High-speed mode** option is preceded by a dot.
6. Select **OK** on the **Change Port Mode** confirmation message (refer to Figure 4.35) to update the setting, or select **Cancel** to cancel the setting. **Important:** these changes are not yet implemented in the disk subsystem.
7. If you want to apply the changes to the subsystem, select **Apply** and then select **OK** on the confirmation message (refer to Figure 4.7).
8. If you want to cancel the changes and not apply them to the subsystem, select **Cancel** and then select **OK** on the confirmation message (refer to Figure 4.8).

Table 4.3 lists the port serial numbers and port names for standard mode, and Table 4.4 indicates that information for high-speed mode.

**Table 4.3 Port Serial Numbers and Port Names (4-port PCB)**

| Port serial number | 8GSE (2MP)    |                 | 8HSE/8HLE (4MP) |                 |
|--------------------|---------------|-----------------|-----------------|-----------------|
|                    | Standard mode | High-speed mode | Standard mode   | High-speed mode |
| 0x00               | CL1-A         | CL1-A           | CL1-A           | CL1-A           |
| 0x01               | -             | -               | CL1-B           | CL1-B [A 2nd]   |
| 0x02               | CL1-C         | CL1-C [A 3rd]   | CL1-C           | CL1-C [A 3rd]   |
| 0x03               | -             | -               | CL1-D           | CL1-D [A 4th]   |
| 0x04               | CL1-E         | CL1-E           | CL1-E           | CL1-E           |
| 0x05               | -             | -               | CL1-F           | CL1-F [E 2nd]   |
| 0x06               | CL1-G         | CL1-G [A 3rd]   | CL1-G           | CL1-G [E 3rd]   |
| 0x07               | -             | -               | CL1-H           | CL1-H [E 4th]   |
| 0x08               | CL1-J         | CL1-J           | CL1-J           | CL1-J           |
| 0x09               | -             | -               | CL1-K           | CL1-K [J 2nd]   |
| 0x0A               | CL1-L         | CL1-L [J 3rd]   | CL1-L           | CL1-L [J 3rd]   |
| 0x0B               | -             | -               | CL1-M           | CL1-M [J 4th]   |
| 0x0C               | CL1-N         | CL1-N           | CL1-N           | CL1-N           |
| 0x0D               | -             | -               | CL1-P           | CL1-P [N 2nd]   |
| 0x0E               | CL1-Q         | CL1-Q [N 3rd]   | CL1-Q           | CL1-Q [N 3rd]   |
| 0x0F               | -             | -               | CL1-R           | CL1-R [N 4th]   |
| 0x10               | CL2-A         | CL2-A           | CL2-A           | CL2-A           |
| 0x11               | -             | -               | CL2-B           | CL2-B [A 2nd]   |
| 0x12               | CL2-C         | CL2-C [A 3rd]   | CL2-C           | CL2-C [A 3rd]   |
| 0x13               | -             | -               | CL2-D           | CL2-D [A 4th]   |
| 0x14               | CL2-E         | CL2-E           | CL2-E           | CL2-E           |
| 0x15               | -             | -               | CL2-F           | CL2-F [E 2nd]   |
| 0x16               | CL2-G         | CL2-G [A 3rd]   | CL2-G           | CL2-G [E 3rd]   |
| 0x17               | -             | -               | CL2-H           | CL2-H [E 4th]   |
| 0x18               | CL2-J         | CL2-J           | CL2-J           | CL2-J           |
| 0x19               | -             | -               | CL2-K           | CL2-K [J 2nd]   |
| 0x1A               | CL2-L         | CL2-L [J 3rd]   | CL2-L           | CL2-L [J 3rd]   |
| 0x1B               | -             | -               | CL2-M           | CL2-M [J 4th]   |
| 0x1C               | CL2-N         | CL2-N           | CL2-N           | CL2-N           |
| 0x1D               | -             | -               | CL2-P           | CL2-P [N 2nd]   |
| 0x1E               | CL2-Q         | CL2-Q [N 3rd]   | CL2-Q           | CL2-Q [N 3rd]   |
| 0x1F               | -             | -               | CL2-R           | CL2-R [N 4th]   |
| 0x20               | CL1-B         | CL1-B [A 2nd]   | -               | -               |
| 0x21               | -             | -               | -               | -               |

| Port serial number | 8GSE (2MP)    |                 | 8HSE/8HLE (4MP) |                 |
|--------------------|---------------|-----------------|-----------------|-----------------|
|                    | Standard mode | High-speed mode | Standard mode   | High-speed mode |
| 0x22               | CL1-D         | CL1-D [A 4th]   | -               | -               |
| 0x23               | -             | -               | -               | -               |
| 0x24               | CL1-F         | CL1-F [E 2nd]   | -               | -               |
| 0x25               | -             | -               | -               | -               |
| 0x26               | CL1-H         | CL1-H [E 4th]   | -               | -               |
| 0x27               | -             | -               | -               | -               |
| 0x28               | CL1-K         | CL1-K [J 2nd]   | -               | -               |
| 0x29               | -             | -               | -               | -               |
| 0x2A               | CL1-M         | CL1-M [J 4th]   | -               | -               |
| 0x2B               | -             | -               | -               | -               |
| 0x2C               | CL1-P         | CL1-P [N 2nd]   | -               | -               |
| 0x2D               | -             | -               | -               | -               |
| 0x2E               | CL1-R         | CL1-R [N 4th]   | -               | -               |
| 0x2F               | -             | -               | -               | -               |
| 0x30               | CL2-B         | CL2-B [A 2nd]   | -               | -               |
| 0x31               | -             | -               | -               | -               |
| 0x32               | CL2-D         | CL2-D [A 4th]   | -               | -               |
| 0x33               | -             | -               | -               | -               |
| 0x34               | CL2-F         | CL2-F [E 2nd]   | -               | -               |
| 0x35               | -             | -               | -               | -               |
| 0x36               | CL2-H         | CL2-H [E 4th]   | -               | -               |
| 0x37               | -             | -               | -               | -               |
| 0x38               | CL2-K         | CL2-K [J 2nd]   | -               | -               |
| 0x39               | -             | -               | -               | -               |
| 0x3A               | CL2-M         | CL2-M [J 4th]   | -               | -               |
| 0x3B               | -             | -               | -               | -               |
| 0x3C               | CL2-P         | CL2-P [N 2nd]   | -               | -               |
| 0x3D               | -             | -               | -               | -               |
| 0x3E               | CL2-R         | CL2-R [N 4th]   | -               | -               |
| 0x3F               | -             | -               | -               | -               |

**Note:** The minus symbol (-) indicates that the port is not available.

**Table 4.4 Port Serial Numbers and Port Names (2-port PCB)**

| Port serial number | 4HSE (2MP)    |                 |
|--------------------|---------------|-----------------|
|                    | Standard mode | High-speed mode |
| 0x00               | CL1-A         | CL1-A           |
| 0x01               | -             | -               |
| 0x02               | CL1-C         | CL1-C [A 3rd]   |
| 0x03               | -             | -               |
| 0x04               | CL1-E         | CL1-E           |
| 0x05               | -             | -               |
| 0x06               | CL1-G         | CL1-G [A 3rd]   |
| 0x07               | -             | -               |
| 0x08               | CL1-J         | CL1-J           |
| 0x09               | -             | -               |
| 0x0A               | CL1-L         | CL1-L [J 3rd]   |
| 0x0B               | -             | -               |
| 0x0C               | CL1-N         | CL1-N           |
| 0x0D               | -             | -               |
| 0x0E               | CL1-Q         | CL1-Q [N 3rd]   |
| 0x0F               | -             | -               |
| 0x10               | CL2-A         | CL2-A           |
| 0x11               | -             | -               |
| 0x12               | CL2-C         | CL2-C [A 3rd]   |
| 0x13               | -             | -               |
| 0x14               | CL2-E         | CL2-E           |
| 0x15               | -             | -               |
| 0x16               | CL2-G         | CL2-G [A 3rd]   |
| 0x17               | -             | -               |
| 0x18               | CL2-J         | CL2-J           |
| 0x19               | -             | -               |
| 0x1A               | CL2-L         | CL2-L [J 3rd]   |
| 0x1B               | -             | -               |
| 0x1C               | CL2-N         | CL2-N           |
| 0x1D               | -             | -               |
| 0x1E               | CL2-Q         | CL2-Q [N 3rd]   |
| 0x1F               | -             | -               |

**Note:** The minus symbol (-) indicates that the port is not available.

# Chapter 5 Troubleshooting

## 5.1 Troubleshooting

- For troubleshooting information on the 9900V subsystem, please refer to the *Hitachi Freedom Storage™ Lightning 9900™ V Series User and Reference Guide* (MK-92RD100).
- For information on the 9900V Remote Console software error codes, please refer to the *Hitachi Freedom Storage™ Lightning 9900™ V Series Hitachi Remote Console - Storage Navigator Error Codes* (MK-92RD132).

The user is responsible for the operation and normal maintenance of the PC(s), which host the 9900V Remote Console software. Here are some guidelines for troubleshooting 9900V Remote Console software operations:

- **Check the cabling and the LAN.** Verify that both the computer and LAN cabling are firmly attached, and that the LAN is operating properly.
- **Reboot the PC.** Close any programs that are not responding. If necessary, reboot the PC and restart the 9900V Java™ applet program.
- **Check for any General Error Conditions.** Check the troubleshooting information in the *Hitachi Lightning 9900V Hitachi Remote Console - Storage Navigator User's Guide*. The document lists general error conditions and provides recommended resolution for each condition. If you are still unable to resolve an error condition, please call the Hitachi Data Systems Support Center for assistance (see section 5.2 for contact information).
- **Check the status lamp on the Hitachi Remote Console - Storage Navigator.** If the lamp becomes yellow (🟡) or red (🔴), confirm the severity level of the error on the **Status** tab of the Remote Console Main panel. If you are unable to resolve an error condition, please contact the Hitachi Data Systems Support Center (see section 5.2).
- **Download the Remote Console trace files using the FD Dump Tool.** If you are unable to resolve an error condition, copy the 9900V Remote Console configuration information onto diskette using the FD Dump Tool). Contact the Hitachi Data Systems Support Center (see section 5.2), and give this information on the floppy disk(s) to the Hitachi Data Systems service personnel.

**Table 5.1 General Error Conditions**

| Error Condition                                                                                                                                                                                                                                                                                      | Probable Cause / Recommended Action                                                                                                                                                                                                                                           |
|------------------------------------------------------------------------------------------------------------------------------------------------------------------------------------------------------------------------------------------------------------------------------------------------------|-------------------------------------------------------------------------------------------------------------------------------------------------------------------------------------------------------------------------------------------------------------------------------|
| <b>Application Error</b>                                                                                                                                                                                                                                                                             |                                                                                                                                                                                                                                                                               |
| The Remote Console experiences an error.                                                                                                                                                                                                                                                             | Save the Java™ log file on the Remote Console, and report to the Hitachi Data Systems Technical Support Center.<br>For Windows® 2000, the Java™ log file is in the following place:<br>c:\Documents and Settings\login user ID\plugin131.trace<br>Restart the Remote Console. |
| Only the Exit and Refresh buttons are effective when accessing the SVP from the Remote Console.                                                                                                                                                                                                      | The SVP might not be ready or perform some write processes from the other system. Wait for a while, and then select the Refresh button.                                                                                                                                       |
| <b>Abnormal End / No Response</b>                                                                                                                                                                                                                                                                    |                                                                                                                                                                                                                                                                               |
| An internal error occurs, or a web browser ends abnormally (forcibly).                                                                                                                                                                                                                               | Close all panels including the Storage Device List panel, and then log on to the Remote Console again. If the same error occurs, restart the Remote Console.                                                                                                                  |
| A network error occurred. There is no response to an operation even after 30 minutes passed.                                                                                                                                                                                                         | Restart the Remote Console.                                                                                                                                                                                                                                                   |
| <b>Incorrect Display/ Disoperation</b>                                                                                                                                                                                                                                                               |                                                                                                                                                                                                                                                                               |
| After dragging and dropping objects to another location or area, the scroll bar on that location becomes unusable.                                                                                                                                                                                   | Close all panels including the Storage Device List panel, and then log on to the Remote Console again.                                                                                                                                                                        |
| A focus disappears from the edit box.                                                                                                                                                                                                                                                                | Close all panels including the Storage Device List panel, and then log on to the Remote Console again.                                                                                                                                                                        |
| The display of the web browser becomes incorrect, because some GUI items such as labels and icons cannot be downloaded properly.                                                                                                                                                                     | Log off from the Remote Console and then re-log in.                                                                                                                                                                                                                           |
| A Remote Console panel is closed by:<br>– Selecting the  button on the panel,<br>– Using the commands such as <b>File</b> and <b>Exit</b> on the web browser, or<br>– Pressing the <b>Alt</b> and <b>F4</b> keys. | Wait for an RMI™ time-out (default is 1 min.), and then restart the Remote Console.                                                                                                                                                                                           |
| <b>Maintenance / Others</b>                                                                                                                                                                                                                                                                          |                                                                                                                                                                                                                                                                               |
| The program on the SVP is updated.                                                                                                                                                                                                                                                                   | Exit all web browsers on the Remote Console, and then restart the browsers. If in doubt, you should exit and restart the browsers.                                                                                                                                            |
| The time of the clock on the Remote Console is reset.                                                                                                                                                                                                                                                | Clear cache (the existing temporary Internet files) of the web browser before logging on to the Remote Console.                                                                                                                                                               |
| Remote Console processing is temporarily delayed.                                                                                                                                                                                                                                                    | An internal processing (e.g., configuration change, Program Product. check, operational information acquisition, etc.) might be being executed on the SVP (web server).                                                                                                       |
| If you are unable to resolve an error condition.                                                                                                                                                                                                                                                     | Copy the 9900V Remote Console configuration information onto floppy disk(s) using the <b>FD Dump Tool</b> and contact the Hitachi Data Systems Technical Support Center (see section 5.2).                                                                                    |



## 5.2 Calling the Hitachi Data Systems Technical Support Center

If you need to call the Hitachi Data Systems Technical Support Center, be sure to provide as much information about the problem as possible. Include the circumstances surrounding the error or failure, the 9900V Remote Console configuration information saved in the floppy diskette(s) by the **FD Dump Tool**, the exact content of any messages displayed on the Remote Console, and the severity levels and reference codes displayed on the **Status** tab of the Remote Console Main panel. The worldwide Hitachi Data Systems Technical Support Centers are:

- Hitachi Data Systems North America/Latin America  
San Diego, California, USA  
1-800-348-4357
- Hitachi Data Systems Europe  
Contact Hitachi Data Systems Local Support
- Hitachi Data Systems Asia Pacific  
North Ryde, Australia  
011-61-2-9325-3300



## Glossary, Acronyms, and Abbreviations

|                                 |                                                                                                                                                                                                                                                                                                                     |
|---------------------------------|---------------------------------------------------------------------------------------------------------------------------------------------------------------------------------------------------------------------------------------------------------------------------------------------------------------------|
| Command Control Interface (CCI) | System administrators can enter Command Control Interface (CCI) commands from open-system hosts to perform Hitachi TrueCopy and ShadowImage operations on logical devices.                                                                                                                                          |
| CruiseControl                   | CruiseControl performs automatic relocation of volumes to optimize performance.                                                                                                                                                                                                                                     |
| CU                              | Control Unit. The 9900V subsystem supports a maximum of 16 logical control unit (CU) images, numbered sequentially from 0 to F. Each CU image controls up to 256 LDEVs.                                                                                                                                             |
| Custom Access                   | A feature that allows a non-administrator to be assigned write access to one or more of the restricted Remote Console functions.                                                                                                                                                                                    |
| DASD                            | Direct-Access Storage Device                                                                                                                                                                                                                                                                                        |
| DKC                             | Disk Controller. The 9900V disk controller provides up to sixteen logical control unit (CU) images and supports 3990-6, 3990-6E, 2105-F20, OPEN-#, OPEN-9 and OPEN-L disk controller emulation.                                                                                                                     |
| DKU                             | Disk Array Unit. The 9900V subsystem has up to six disk array frames containing the storage components (disk drive arrays) of the subsystem.                                                                                                                                                                        |
| ESCON®                          | Enterprise System Connection                                                                                                                                                                                                                                                                                        |
| Export File                     | The Export File function allows you to export data (e.g., monitoring data used by Performance Monitor or Hitachi TrueCopy) to data files.                                                                                                                                                                           |
| FD                              | floppy disk                                                                                                                                                                                                                                                                                                         |
| FD Dump Tool                    | This function downloads the 9900V Remote Console configuration information onto a floppy diskette or a hard disk drive, and is generally used for troubleshooting purposes.                                                                                                                                         |
| FICON™                          | Fibre Connection                                                                                                                                                                                                                                                                                                    |
| FlashAccess                     | FlashAccess (Dynamic Cache Residence) enables you to store specific high-usage data directly in cache memory to provide virtually immediate data availability.                                                                                                                                                      |
| GB                              | gigabyte(s)                                                                                                                                                                                                                                                                                                         |
| Hi-Star™                        | Hierarchical Star Network architecture improves the total performance of internal data transfer by using high-speed crossbar changes.                                                                                                                                                                               |
| HMBR                            | Hitachi Multiplatform Backup/Restore                                                                                                                                                                                                                                                                                |
| Java™ applet program            | The web client Java™ applet program runs on a web browser on the Remote Console. When a Remote Console user accesses and logs on to the desired SVP, the web client Java™ applet is downloaded from the SVP to the Remote Console. The web client Java™ applet program runs on a web browser on the Remote Console. |
| JVM™                            | Java Virtual Machine™ is the web client Java™ applet program that is installed in each SVP and runs using web browsers to provide a user-friendly interface for the 9900V Remote Console functions.                                                                                                                 |

|                        |                                                                                                                                                                                                                                                                              |
|------------------------|------------------------------------------------------------------------------------------------------------------------------------------------------------------------------------------------------------------------------------------------------------------------------|
| kB                     | kilobyte(s)                                                                                                                                                                                                                                                                  |
| LAN                    | local-area network                                                                                                                                                                                                                                                           |
| LBA                    | logical block address                                                                                                                                                                                                                                                        |
| LDEV                   | logical device. An LDEV used by mainframe hosts can be called a device, logical volume image (LVI) or a volume. An LDEV used by open-system hosts is called a logical unit (LU).                                                                                             |
| LU                     | An LDEV used by open-system hosts is called a logical unit (LU). Open-system fibre interfaces access LUs that are mapped to one or more LDEVs.                                                                                                                               |
| LUN                    | logical unit number is an identifying number for an LU.                                                                                                                                                                                                                      |
| LUN Manager            | Remote Console software option that enables you to configure the 9900V fibre-channel ports for operational environments, and restrict host access to LUs.                                                                                                                    |
| LUSE                   | LUN Expansion. This function allows you to concatenate two or more volumes into a larger volume.                                                                                                                                                                             |
| LVI                    | Logical Volume Image (also called device emulation)                                                                                                                                                                                                                          |
| MB                     | megabyte(s)                                                                                                                                                                                                                                                                  |
| MIB                    | message information block                                                                                                                                                                                                                                                    |
| Open Volume Management | A suite of options that includes Virtual LVI/LUN and LUSE (LUN Expansion). Virtual LVI/LUN divides a logical volume for open-system into two or more volumes. LUN Expansion allows you to concatenate two or more volumes into a larger volume.                              |
| Parity group           | A set of hard disk drives that have the same capacity and are treated as one group. A parity group contains both user data and parity information, which allows the user data to be accessed in the event that one or more of the drives within the group are not available. |
| RMI™                   | Remote Method Invocation. RMI™ is a remote procedure call, which allows Java™ objects stored in the network to be run remotely.                                                                                                                                              |
| R-SIM                  | remote service information message (generated by the 9900V when it detects an error or service requirement).                                                                                                                                                                 |
| SIM                    | service information message (generated by a subsystem when it detects an error or service requirement).                                                                                                                                                                      |
| ShadowImage            | An option that allows you to maintain subsystem-internal copies of all user data for purposes such as data backup and duplication.                                                                                                                                           |
| SNMP                   | simple network management protocol (part of the TCP/IP protocol suite)                                                                                                                                                                                                       |
| SSID                   | storage subsystem ID. The 9900V is configured with one SSID for each 64 devices, and up to four SSIDs for each CU image.                                                                                                                                                     |
| SVP                    | Service Processor (this is the notebook computer that is inside the RAID450).                                                                                                                                                                                                |
| TCP/IP                 | transmission control protocol/internet protocol                                                                                                                                                                                                                              |
| TID                    | target ID                                                                                                                                                                                                                                                                    |
| Trap                   | An SNMP agent initiates trap operations when R-SIMs occur, in order to send the R-SIMs to the SNMP manager (see Figure 4.1). An SNMP agent can be configured to deliver traps to more than one SNMP manager.                                                                 |
| TrueCopy               | TrueCopy is an option product that allows you to perform host-free remote                                                                                                                                                                                                    |

|                   |                                                                                                                                                                                                                  |
|-------------------|------------------------------------------------------------------------------------------------------------------------------------------------------------------------------------------------------------------|
|                   | copy operations between 9900V subsystems in different locations for data backup and disaster recovery purposes.                                                                                                  |
| UCB               | unit control block                                                                                                                                                                                               |
| User account list | The user account list includes user information such as user ID, password, and write permission for each 9900V option.                                                                                           |
| VLL               | Virtual LVI/ LUN is an option that enables you to configure custom-size logical device images and logical units, which are smaller than standard-size devices.                                                   |
| Volser            | volume serial number (mainframe volume identifier, not related to the LDEV ID)                                                                                                                                   |
| Remote Console    | The Remote Console communicates directly with the service processor (SVP) of each attached subsystem to obtain subsystem configuration and status information and send user-requested commands to the subsystem. |
| WWN               | Worldwide Name is a unique identifier for a particular open-system host bus adapter, consisting of a 64-bit physical address (the IEEE 48-bit format with 12-bit extension and 4-bit prefix).                    |

