



Sun™ XVR-500 Graphics Accelerator Installation Guide

Sun Microsystems, Inc.
4150 Network Circle
Santa Clara, CA 95054 U.S.A.
650-960-1300

Part No. 816-3028-12
September 2002, Revision A

Send comments about this document to: docfeedback@sun.com

Copyright 2002 Sun Microsystems, Inc., 4150 Network Circle, Santa Clara, California 95054, U.S.A. All rights reserved.

Sun Microsystems, Inc. has intellectual property rights relating to technology embodied in the product that is described in this document. In particular, and without limitation, these intellectual property rights may include one or more of the U.S. patents listed at <http://www.sun.com/patents> and one or more additional patents or pending patent applications in the U.S. and in other countries.

This document and the product to which it pertains are distributed under licenses restricting their use, copying, distribution, and decompilation. No part of the product or of this document may be reproduced in any form by any means without prior written authorization of Sun and its licensors, if any.

Third-party software, including font technology, is copyrighted and licensed from Sun suppliers.

Parts of the product may be derived from Berkeley BSD systems, licensed from the University of California. UNIX is a registered trademark in the U.S. and in other countries, exclusively licensed through X/Open Company, Ltd.

Sun, Sun Microsystems, the Sun logo, Sun Blade, Sun Fire, SunService, AnswerBook2, docs.sun.com, Ultra, OpenWindows, and Solaris are trademarks or registered trademarks of Sun Microsystems, Inc. in the U.S. and in other countries.

All SPARC trademarks are used under license and are trademarks or registered trademarks of SPARC International, Inc. in the U.S. and in other countries. Products bearing SPARC trademarks are based upon an architecture developed by Sun Microsystems, Inc.

The OPEN LOOK and Sun™ Graphical User Interface was developed by Sun Microsystems, Inc. for its users and licensees. Sun acknowledges the pioneering efforts of Xerox in researching and developing the concept of visual or graphical user interfaces for the computer industry. Sun holds a non-exclusive license from Xerox to the Xerox Graphical User Interface, which license also covers Sun's licensees who implement OPEN LOOK GUIs and otherwise comply with Sun's written license agreements. OpenGL is a registered trademark of Silicon Graphics, Inc.

Use, duplication, or disclosure by the U.S. Government is subject to restrictions set forth in the Sun Microsystems, Inc. license agreements and as provided in DFARS 227.7202-1(a) and 227.7202-3(a) (1995), DFARS 252.227-7013(c)(1)(ii) (Oct. 1998), FAR 12.212(a) (1995), FAR 52.227-19, or FAR 52.227-14 (ALT III), as applicable.

DOCUMENTATION IS PROVIDED "AS IS" AND ALL EXPRESS OR IMPLIED CONDITIONS, REPRESENTATIONS AND WARRANTIES, INCLUDING ANY IMPLIED WARRANTY OF MERCHANTABILITY, FITNESS FOR A PARTICULAR PURPOSE OR NON-INFRINGEMENT, ARE DISCLAIMED, EXCEPT TO THE EXTENT THAT SUCH DISCLAIMERS ARE HELD TO BE LEGALLY INVALID.

Copyright 2002 Sun Microsystems, Inc., 4150 Network Circle, Santa Clara, California 95054, Etats-Unis. Tous droits réservés.

Sun Microsystems, Inc. a les droits de propriété intellectuels relatants à la technologie incorporée dans le produit qui est décrit dans ce document. En particulier, et sans la limitation, ces droits de propriété intellectuels peuvent inclure un ou plus des brevets américains énumérés à <http://www.sun.com/patents> et un ou les brevets plus supplémentaires ou les applications de brevet en attente dans les Etats-Unis et dans les autres pays.

Ce produit ou document est protégé par un copyright et distribué avec des licences qui en restreignent l'utilisation, la copie, la distribution, et la décompilation. Aucune partie de ce produit ou document ne peut être reproduite sous aucune forme, par quelque moyen que ce soit, sans l'autorisation préalable et écrite de Sun et de ses bailleurs de licence, s'il y en a.

Le logiciel détenu par des tiers, et qui comprend la technologie relative aux polices de caractères, est protégé par un copyright et licencié par des fournisseurs de Sun.

Des parties de ce produit pourront être dérivées des systèmes Berkeley BSD licenciés par l'Université de Californie. UNIX est une marque déposée aux Etats-Unis et dans d'autres pays et licenciée exclusivement par X/Open Company, Ltd.

Sun, Sun Microsystems, le logo Sun, Sun Blade, Sun Fire, SunService, AnswerBook2, docs.sun.com, Ultra, OpenWindows, et Solaris sont des marques de fabrique ou des marques déposées de Sun Microsystems, Inc. aux Etats-Unis et dans d'autres pays.

Toutes les marques SPARC sont utilisées sous licence et sont des marques de fabrique ou des marques déposées de SPARC International, Inc. aux Etats-Unis et dans d'autres pays. Les produits portant les marques SPARC sont basés sur une architecture développée par Sun Microsystems, Inc.

L'interface d'utilisation graphique OPEN LOOK et Sun™ a été développée par Sun Microsystems, Inc. pour ses utilisateurs et licenciés. Sun reconnaît les efforts de pionniers de Xerox pour la recherche et le développement du concept des interfaces d'utilisation visuelle ou graphique pour l'industrie de l'informatique. Sun détient une licence non exclusive de Xerox sur l'interface d'utilisation graphique Xerox, cette licence couvrant également les licenciés de Sun qui mettent en place l'interface d'utilisation graphique OPEN LOOK et qui en outre se conforment aux licences écrites de Sun. OpenGL est une marque déposée de Silicon Graphics, Inc.

LA DOCUMENTATION EST FOURNIE "EN L'ÉTAT" ET TOUTES AUTRES CONDITIONS, DECLARATIONS ET GARANTIES EXPRESSES OU TACITES SONT FORMELLEMENT EXCLUES, DANS LA MESURE AUTORISÉE PAR LA LOI APPLICABLE, Y COMPRIS NOTAMMENT TOUTE GARANTIE IMPLICITE RELATIVE A LA QUALITE MARCHANDE, A L'APTITUDE A UNE UTILISATION PARTICULIERE OU A L'ABSENCE DE CONTREFAÇON.

Contents

Preface ix

- 1. Sun XVR-500 Graphics Accelerator Overview 1**
 - Sun XVR-500 Graphics Accelerator Features 2
 - Installation Kit 4
 - Technical Support 4

- 2. Installing the Sun XVR-500 Graphics Accelerator Software 5**
 - Software Requirements 5
 - Sun XVR-500 Graphics Accelerator Software Packages 6
 - Sun OpenGL for Solaris Software 7
 - Installing the Software 10
 - Removing the Software 13
 - Important Note for JumpStart Users 15
 - Man Pages 15

- 3. Installing the Sun XVR-500 Graphics Accelerator Hardware 17**
 - Before Installation 17
 - System Configurations 18
 - Installing the Hardware 19
 - Installing the Hardware in Sun Blade 1000 and 2000 Systems 20

	Configuring Multiple Frame Buffers	21
	Changing the Monitor Screen Resolution	22
4.	Sun XVR-500 Graphics Accelerator Frame Locking	23
	Sun XVR-500 Graphics Accelerator Frame Lock System	23
	Configuring Sun XVR-500 Graphics Accelerators for Frame Locking	25
	Frame Lock Cable Assembly	27
	Connecting the Frame Lock Cable Assembly	28
A.	Sun XVR-500 Graphics Accelerator Specifications	31
	I/O Port Specifications	31
	Screen Resolutions and Video Formats	34
	Accessing Field Replaceable Unit Information	35
B.	Setting the Default Console Display for the Sun Blade 1000 and 2000 Systems	37

Figures

- FIGURE 1-1 Sun XVR-500 Graphics Accelerator 1
- FIGURE 1-2 Sun XVR-500 Graphics Accelerator External I/O Port Connectors 3
- FIGURE 3-1 Sun XVR-500 Graphics Accelerator ASIC Heatsink 19
- FIGURE 3-2 Installing Sun XVR-500 Graphics Accelerator in a Sun Blade 1000/2000 System 21
- FIGURE 4-1 Frame Lock Cable Assembly 27
- FIGURE 4-2 Sun XVR-500 Graphics Accelerator and Frame Lock Cable Assembly 29

Tables

TABLE 2-1	Location of Sun XVR-500 Graphics Accelerator Software Packages	6
TABLE 2-2	Solaris 8 and Solaris 9 Software Package Names	6
TABLE 2-3	Sun XVR-500 Graphics Accelerator Patches	7
TABLE 2-4	Location of Sun OpenGL for Solaris Software Packages	7
TABLE 2-5	Package Names for Sun OpenGL Version 1.2.1, 1.2.2, and 1.2.3	8
TABLE 2-6	Sun OpenGL Version 1.2.1 for Solaris Patches	9
TABLE 2-7	Sun OpenGL Version 1.2.2 for Solaris Patches	9
TABLE 2-8	Sun OpenGL Version 1.2.3 for Solaris Patches	9
TABLE 3-1	Supported Number of Sun XVR-500 Graphics Accelerators	18
TABLE 4-1	Supported Systems	24
TABLE 4-2	Frame Lock Cable Connections	27
TABLE A-1	Sun XVR-500 Graphics Accelerator HD15 Video Output Port	32
TABLE A-2	Sun XVR-500 Graphics Accelerator Stereo Connector Pinout	33
TABLE A-3	Sun XVR-500 Graphics Accelerator Monitor Screen Resolutions	34

Preface

This guide describes how to install the Sun™ XVR-500 graphics accelerator and associated software in a Sun system.

How This Book Is Organized

Chapter 1 provides an overview of the Sun XVR-500 graphics accelerator product features.

Chapter 2 describes how to install the Sun XVR-500 graphics accelerator software.

Chapter 3 provides installation information for the Sun XVR-500 graphics accelerator hardware.

Chapter 4 describes Sun XVR-500 graphics accelerator frame locking.

Appendix A provides Sun XVR-500 graphics accelerator I/O specifications.

Appendix B describes how to set the Sun XVR-500 graphics accelerator as the default monitor console display for Sun Blade™ 1000 and Sun Blade 2000 systems only.

Using UNIX Commands

This document does not contain information on basic UNIX® commands and procedures such as shutting down the system, booting the system, and configuring devices.

See one or more of the following for this information:

- *Solaris Handbook for Sun Peripherals*
- AnswerBook2™ online documentation for the Solaris™ operating environment
- Other software documentation that you received with your system

Typographic Conventions

Typeface	Meaning	Examples
AaBbCc123	The names of commands, files, and directories; on-screen computer output.	Edit your <code>.login</code> file. Use <code>ls -a</code> to list all files. % You have mail.
AaBbCc123	What you type, when contrasted with on-screen computer output.	% su Password:
<i>AaBbCc123</i>	Book titles, new words, or terms; words to be emphasized; command-line variable: replace with a real name or value.	Read Chapter 6 in the <i>User's Guide</i> . These are called <i>class</i> options. You <i>must</i> be root to do this. To delete a file, type <code>rm filename</code> .

Shell Prompts

Shell	Prompt
C shell	%
C shell superuser	#
Bourne shell and Korn shell	\$
Bourne shell and Korn shell superuser	#

Accessing Sun Documentation

You can view and print a broad selection of Sun documentation, including localized versions, at:

<http://www.sun.com/documentation>

You can also purchase printed copies of select Sun documentation from iUniverse, the Sun documentation provider, at:

<http://corppub.iuniverse.com/marketplace/sun/>

Sun Welcomes Your Comments

Sun is interested in improving its documentation and welcomes your comments and suggestions. You can email your comments to Sun at:

docfeedback@sun.com

Please include the part number, 816-3028-12, of your document in the subject line of your email.

Sun XVR-500 Graphics Accelerator Overview

The Sun XVR-500 graphics accelerator is a high-resolution, high-performance graphics frame buffer that provides hardware texture mapping. This chapter includes the following topics:

- “Sun XVR-500 Graphics Accelerator Features” on page 2
- “Installation Kit” on page 4
- “Technical Support” on page 4

The Sun XVR-500 graphics accelerator (FIGURE 1-1) is supported on the following systems:

- Sun Blade 150 system
- Sun Blade 1000 and Sun Blade 2000 systems
- Sun Fire™ V480 server
- Sun Fire V880 server

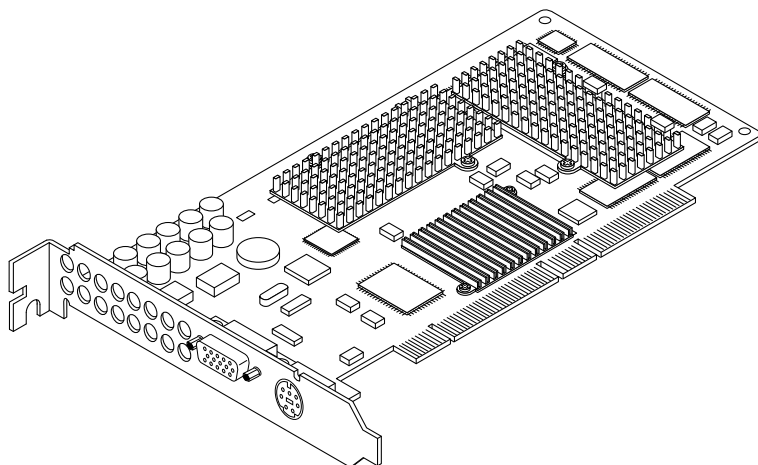

FIGURE 1-1 Sun XVR-500 Graphics Accelerator

Sun XVR-500 Graphics Accelerator Features

- FRU ID (field replacable unit identification allows you to identify the Sun XVR-500 graphics accelerator serial number and other data using `fbconfig`.)
- OpenGL 1.2 implementation. For more information access this URL:
<http://opengl.org>
- Geometry acceleration
 - Model view matrix transformation of vertex and normal coordinates
 - Texture matrix transformation of texture coordinates
 - Full lighting calculations with up to 24 light sources
 - Up to six user clip planes
 - Perspective transformation
 - Viewport transformation
 - View volume clipping
 - Image processing
- OpenGL operations
 - Points (2D, 3D, wide)
 - Vectors (2D and 3D lines and line strips; wide, stippled)
 - Polygons (triangles, triangle strips, quads, quad strips, polygons, point/line polygon mode)
 - Antialiased points, vectors, and polygons
 - Image support (multiple formats, zoom, bilinear scaling, color matrix, color tables)
 - Alpha operations
 - Scissoring
 - Window clipping
 - Masking
 - Fogging (linear, exponential, exponential², user-defined)
 - Texture mapping (point, bilinear, trilinear, multiple internal formats)
 - Stencil operations
 - Rich set of blending operations
 - Fast window clears
 - Fast window-mode double buffering
 - Frame-sequential stereo support
- Extensive support of OpenGL extensions
 - Imaging extensions such as pixel buffer, color table, and color matrix
 - Blend extensions such as blend color, blend minmax, and blend function separate
 - Texture extensions (edge clamp, border clamp, LOD clamp)
 - Texture color table

- Post-texturing specular
- Stencil operation wrap

Additional Features

- 16 Mbytes of SDRAM display list memory
- 16 Mbytes on-board SDRAM texture memory with full mipmapped trilinear interpolated texture processing
- 32 Mbytes of frame buffer SDRAM memory
- 10-bit gamma correction
- Hardware cursor
- Stereoscopic viewing support (frame sequential)
- Multisample for antialiased Sun OpenGL for Solaris
- Display Data Channel (DDC) monitor support for bidirectional communication
- Display Power Management Signaling (DPMS) to enable monitor's power-saving mode
- High-speed, full-featured DMA over the PCI-64 bus
- Multiscreen support using multiple boards in a single workstation
- Two video lookup tables

FIGURE 1-2 shows the Sun XVR-500 graphics accelerator external I/O ports. The graphics board I/O ports are described in Appendix A, “Sun XVR-500 Graphics Accelerator Specifications.”

The Sun XVR-500 graphics accelerator features a system for identifying the board by means of an FRU ID (field replaceable unit identifier). This information is contained on a PROM chip. “Accessing Field Replaceable Unit Information” on page 35 (Appendix A) describes how to identify the graphics board installed in your system.

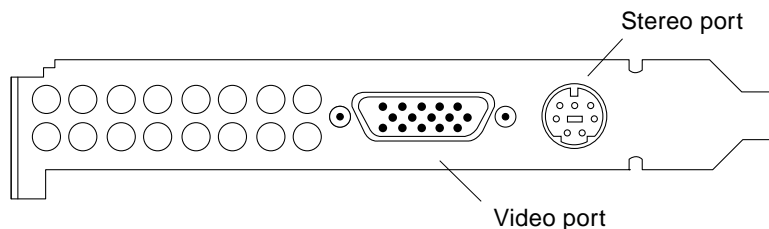

FIGURE 1-2 Sun XVR-500 Graphics Accelerator External I/O Port Connectors

Installation Kit

The Sun XVR-500 graphics accelerator installation kit includes:

- Sun XVR-500 graphics accelerator
- Antistatic wrist strap
- HD15 to 13W3 adaptor cable
- Sun XVR-500 graphics accelerator software (CD)
- *Sun XVR-500 Graphics Accelerator Installation Guide* (this document)

Updated versions of Sun OpenGL[®] for Solaris are available at:

<http://www.sun.com/software/graphics/OpenGL/>

Updated versions of the latest system software patches for the Sun XVR-500 graphics accelerator are available at:

<http://sunsolve.sun.com>

Technical Support

For assistance and other information not found in this document concerning the Sun XVR-500 graphics accelerator, see SunServiceSM at:

<http://www.sun.com/service/online/>

Installing the Sun XVR-500 Graphics Accelerator Software

This chapter provides the Sun XVR-500 graphics accelerator software installation information.

- “Software Requirements” on page 5
- “Sun XVR-500 Graphics Accelerator Software Packages” on page 6
- “Sun OpenGL for Solaris Software” on page 7
- “Installing the Software” on page 10
- “Removing the Software” on page 13
- “Important Note for JumpStart Users” on page 15
- “Man Pages” on page 15

Software Requirements

- Solaris 8 or a subsequent compatible version of the operating environment
- One or more of these graphical user interfaces:
 - OpenWindows™ Version 3.6.2 or a subsequent compatible version, or
 - Common Desktop Environment (CDE)
- 1.5 Mbytes of available disk space for Sun XVR-500 graphics accelerator software
- 42-90 Mbytes of disk space for Sun OpenGL® for Solaris (up to 90 Mbytes if 64-bit Sun OpenGL for Solaris is installed)

Note – If your system does not have the Solaris 8 operating environment installed, you must install it. Use the text command version of `suninstall` to install the required Solaris operating environment. Refer to the main Solaris installation manuals for this information.

Sun XVR-500 Graphics Accelerator Software Packages

The Sun XVR-500 graphics accelerator software is delivered on a CD provided with your installation kit.

Software Package Locations

TABLE 2-1 lists the directory location of the Sun XVR-500 graphics accelerator software packages.

TABLE 2-1 Location of Sun XVR-500 Graphics Accelerator Software Packages

Software Packages	Directory Location
Solaris 8 software	/cdrom/cdrom0/XVR-500/Solaris_8/Packages/
Solaris 9 software	/cdrom/cdrom0/XVR-500/Solaris_9/Packages/

Sun XVR-500 Graphics Accelerator Software Package Names

TABLE 2-2 lists the Sun XVR-500 graphics accelerator software package names and descriptions.

TABLE 2-2 Solaris 8 and Solaris 9 Software Package Names

Package name	Description
SUNWifb.u	32-bit device driver for the PCI bus Sun Expert3D graphics accelerator
SUNWifbcf	Configuration utility for the PCI bus Sun Expert3D graphics accelerator
SUNWifbr	Boot-time device initialization support for the PCI bus Sun Expert3D graphics accelerator
SUNWifbw	X-server loadable module for the PCI bus Sun Expert3D graphics accelerator
SUNWifbx.u	64-bit device driver for the PCI bus Sun Expert3D graphics accelerator

Sun XVR-500 Graphics Accelerator Patches

TABLE 2-3 lists the patches for Sun XVR-500 graphics accelerator software packages.

TABLE 2-3 Sun XVR-500 Graphics Accelerator Patches

Solaris Release	Patch	Location
Solaris 8 software	108576-30	/cdrom/cdrom0/XVR-500/Solaris_8/Patches
Solaris 9 software	112540-04	/cdrom/cdrom0/XVR-500/Solaris_9/Patches

Note – Always check for the latest software patches at:
<http://sunsolve.sun.com/>

Solaris patches for the Sun XVR-500 graphics accelerator software are available at:

<http://sunsolve.sun.com/>

Sun OpenGL for Solaris Software

The Sun XVR-500 graphics accelerator is supported in Sun OpenGL Versions 1.2.1, 1.2.2, 1.2.3 and subsequent compatible Sun OpenGL versions, for Solaris operating environments.

Software Package Locations

TABLE 2-4 lists the directory locations of the Sun OpenGL for Solaris software packages.

TABLE 2-4 Location of Sun OpenGL for Solaris Software Packages

Sun OpenGL for Solaris Software Packages	Directory Location
Sun OpenGL 1.2.1 software	/cdrom/cdrom0/OpenGL/1.2.1/Packages/
Sun OpenGL 1.2.2 software	/cdrom/cdrom0/OpenGL/1.2.2/Packages/
Sun OpenGL 1.2.3 software	/cdrom/cdrom0/OpenGL/1.2.3/Packages/

Updated versions of Sun OpenGL for Solaris are available at:

<http://www.sun.com/software/graphics/OpenGL/>

Sun OpenGL for Solaris Software Package Names

TABLE 2-5 lists the Sun OpenGL for Solaris software package names and descriptions.

TABLE 2-5 Package Names for Sun OpenGL Version 1.2.1, 1.2.2, and 1.2.3

Package Name	Description
SUNWafbg1	Sun OpenGL for Solaris Elite3D support
SUNWafbgx	Sun OpenGL for Solaris 64-bit Elite3D support
SUNWffbg1	Sun OpenGL for Solaris Creator Graphics (FFB) Support
SUNWffbgx	Sun OpenGL for Solaris 64-bit Creator Graphics (FFB) Support
SUNWgfbg1	Sun OpenGL for Solaris Gfb Support
SUNWgfbgx	Sun OpenGL for Solaris 64-bit Gfb Support
SUNWgldoc	Sun OpenGL for Solaris Documentation and Man Pages
SUNWglh	Sun OpenGL for Solaris Header Files
SUNWglrt	Sun OpenGL for Solaris Runtime Libraries
SUNWglrtu	Sun OpenGL for Solaris Platform Specific Runtime Libraries
SUNWglrtx	Sun OpenGL for Solaris 64-bit Runtime Libraries
SUNWglshr	Sun OpenGL for Solaris Runtime Generic Software
SUNWglsrx	Sun OpenGL for Solaris 64-bit Optimized SW Rasterizer
SUNWglsrz	Sun OpenGL for Solaris Optimized SW Rasterizer
SUNWifbg1	Sun OpenGL for Solaris Expert3D Graphics Support
SUNWifbgx	Sun OpenGL for Solaris 64-bit Expert3D Graphics Support

Sun OpenGL for Solaris Patches

TABLE 2-6 lists the Sun OpenGL Version 1.2.1 for Solaris patches.

TABLE 2-6 Sun OpenGL Version 1.2.1 for Solaris Patches

Sun OpenGL Version	Patch	Directory Location
Sun OpenGL 1.2.1 (32-bit)	109543-19	/cdrom/cdrom0/OpenGL/1.2.1/Patches
Sun OpenGL 1.2.1 (64-bit)	109544-19	/cdrom/cdrom0/OpenGL/1.2.1/Patches

TABLE 2-7 lists the Sun OpenGL Version 1.2.2 for Solaris patches.

TABLE 2-7 Sun OpenGL Version 1.2.2 for Solaris Patches

Sun OpenGL Version	Patch	Directory Location
Sun OpenGL 1.2.2 (32-bit)	111993-02	/cdrom/cdrom0/OpenGL/1.2.2/Patches
Sun OpenGL 1.2.2 (64-bit)	111994-02	/cdrom/cdrom0/OpenGL/1.2.2/Patches

TABLE 2-8 lists the Sun OpenGL Version 1.2.3 for Solaris patches.

TABLE 2-8 Sun OpenGL Version 1.2.3 for Solaris Patches

Sun OpenGL Version	Patch	Directory Location
Sun OpenGL 1.2.3 (32-bit)	112628-02	/cdrom/cdrom0/OpenGL/1.2.3/Patches
Sun OpenGL 1.2.3 (64-bit)	112629-02	/cdrom/cdrom0/OpenGL/1.2.3/Patches

Installing and Removing Patches

The Sun XVR-500 graphics accelerator installation script installs patches automatically, if the patches are required.

You can manually install or remove these patches by using `patchadd` and `patchrm`.

- **To add a patch in the Solaris 8 or 9 operating environment, type:**

```
# patchadd patchnumber
```

- To remove a patch in the Solaris 8 or 9 operating environment, type:

```
# patchrm patchnumber
```

Installing the Software

Note – If your system has pre-release versions of the Sun XVR-500 graphics accelerator software, Sun OpenGL for Solaris, or Solaris 9 operating environment, you *must* remove the pre-release Sun XVR-500 graphics accelerator software *before* installing the software on the installation kit CD-ROM. Use the `remove` script to remove previous software versions (see “Removing the Software” on page 13), then do the `install` procedure.

Install the Sun XVR-500 graphics accelerator software from the CD provided with your installation kit.

1. **Log in as superuser.**
2. **Insert the CD into the drive.**
3. **Mount the CD-ROM drive.**
 - If the drive is already mounted, type the following, and go to Step 5:

```
# cd /cdrom/cdrom0
```

- If the CD-ROM is not already mounted, type:

```
# mount -F hsfs -O -o ro /dev/dsk/c0t6d0s0 /cdrom
# cd /cdrom
```

Note – The CD-ROM device may be different on your system. For example, `/dev/dsk/c0t2d0s2`.

4. To install the software, as superuser type:

```
# ./install
```

The following is displayed:

```
This program installs the software for the Sun XVR-500 Graphics Accelerator, Sun Expert3D, and Sun Expert3D-Lite family of graphics accelerators. This install process refers to Sun XVR-500 Graphics Accelerator, but applies to the Sun Expert3D and Sun Expert3D-Lite accelerators as well.
```

```
*** Checking if Sun XVR-500 Graphics Accelerator support is already installed...
*** Checking for required OS patch(es) ...
*** Checking for incompatible OS patch(es) ...
*** Checking if Sun OpenGL is installed...
```

```
Select one of the following Sun OpenGL installation options:
```

- 1) Install Sun OpenGL 1.2.3
- 2) Install Sun OpenGL 1.2.2
- 3) Install Sun OpenGL 1.2.1
- 4) Do not install Sun OpenGL

```
Select an option:
```

The installation program verifies if the Sun XVR-500 graphics accelerator software is already installed. If a version of this software is installed, the program verifies which version is installed.

- If a version of the Sun XVR-500 graphics accelerator software is already installed, and it is lower than the version you are installing from the CD, then the program prompts you to confirm an upgrade to the latest release. The program then installs the patch version.
- If the same version of the Sun XVR-500 graphics accelerator software is already installed, the program verifies that the software is fully installed and displays the following:

```
*** Checking if Sun XVR-500 Graphics Accelerator support is already installed...
*** Checking for required OS patch(es) 108576-30...
*** Checking if Sun OpenGL is installed...
```

```
All required software for Sun XVR-500 Graphics Accelerator and Sun OpenGL support is already installed. No software will be installed at this time.
```

- If a higher version of the Sun XVR-500 graphics accelerator software is already installed, the program will not install the software.

The installation program also displays similar prompts when checking for Sun OpenGL for Solaris versions. If Sun OpenGL for Solaris is fully installed on your system, the program checks for required patches. If no patches are found, the program installs the appropriate patches during the installation process.

5. Select the appropriate Sun OpenGL for Solaris version.

Option 1, Sun OpenGL 1.2.3 for Solaris, is selected for this example:

```
About to take the following actions:
- Install Sun XVR-500 Graphics Accelerator support for Solaris 8
- Install Sun OpenGL 1.2.3

To cancel installation of this software, press 'q'.
Press any other key to begin installation:
```

6. Press any key and Return to start installation.

Once complete, the following is displayed and the program provides a directory for locating a file log of the installation process. The program also provides configuration and reboot instructions.

```
*** Installing Sun XVR-500 Graphics Accelerator support for Solaris 8...
*** Installing Sun OpenGL 1.2.3...
*** Installation complete.

To remove this software, use the 'remove' script on this CDROM, or
the following script:
    /var/tmp/ifb.remove

A log of this installation can be found at:
    /var/tmp/ifb.install.2002.08.06

To configure a Sun XVR-500 Graphics Accelerator, use the fbconfig
utility. See the fbconfig(1m) and SUNWifb_config(1m) manual
pages for more details.

*** IMPORTANT NOTE! ***
This system must be rebooted for the new software to take effect.

Reboot this system as soon as possible using the shutdown command and the
'boot -r' PROM command (see the shutdown(1M) and boot(1M) manual pages
for more details).
```

7. Shut down the system after the Sun XVR-500 graphics accelerator software is installed:

```
# shutdown
```

See the `shutdown(1M)` and `boot(1M)` manual pages for more details. To view the `shutdown` and `boot` man pages, type:

```
# man shutdown
# man boot
```

8. Install the Sun XVR-500 graphics accelerator hardware (see Chapter 3).
9. Reboot the system at the `ok` prompt to complete the installation:

```
ok boot -r
```

Removing the Software

1. Log in as superuser.
2. Insert the Sun XVR-500 graphics accelerator CD into the drive.
3. Mount the CD-ROM drive.
 - If the drive is already mounted, type the following, and go to Step 4:

```
# cd /cdrom/cdrom0
```

- If the CD-ROM is not already mounted, type:

```
# mount -F hsfs -O -o ro /dev/dsk/c0t6d0s0 /cdrom
# cd /cdrom
```

4. To remove Sun XVR-500 software, type:

```
# ./remove
```

The following list of options is displayed.

```
This program removes the software for the Sun XVR-500 Graphics Accelerator, Sun Expert3D, and Sun Expert3D-Lite family of graphics accelerators. This removal process refers to Sun XVR-500 Graphics Accelerator, but applies to the Sun Expert3D and Sun Expert3D-Lite accelerators as well.
```

```
1) Remove Sun XVR-500 Graphics Accelerator support
2) Remove Sun OpenGL
3) Remove All (Sun XVR-500 Graphics Accelerator and Sun OpenGL)
4) Quit
Select an option: 3
```

```
About to take the following actions:
```

- Remove Sun XVR-500 Graphics Accelerator support
- Remove OpenGL

```
Press 'q' to quit, or press any other key to continue:
```

5. Type 3 to remove all packages.

The following then is displayed:

```
About to take the following actions:
```

- Remove Sun XVR-500 Graphics Accelerator support
- Remove OpenGL

```
Press 'q' to quit, or press any other key to continue:
```

6. Press any key and Return to start the removal process.

Once all the packages have been removed, the following is displayed and the program provides a directory for locating a log of the removal process:

```
*** Removing packages...
*** Done. A log of this removal can be found at:
    /var/tmp/ifb.remove.2002.08.06
```

Important Note for JumpStart Users

If you are adding the Sun XVR-500 graphics accelerator Solaris 8 operating environment software to a JumpStart™ server, add the following patches (located on the installation kit CD-ROM in `XVR-500/Solaris_8/Patches`) in the following order:

111310-01
112334-02
111293-01
108528-13
110460-07
109888-16
108576-30

If you are adding these patches to a Solaris 8 2/02 operating environment JumpStart image, only patches 109888-16 and 108576-30 are required. No patches are required for the Solaris 9 operating environment.

Man Pages

The Sun XVR-500 graphics accelerator man pages describe how you can query and set frame buffer attributes such as screen resolutions and visual configurations. The man pages are included in the Solaris `SUNWman` packages bundled with the Solaris operating environment.

Use the `fbconfig(1M)` man page for configuring Sun graphics accelerators. `SUNwifb_config` contains Sun XVR-500 graphics accelerator device-specific configuration information. `fbconfig` and `SUNwifb_config` is included in the Solaris 8 and Solaris 9 operating environments.

Use the `help` option to display the attributes and parameters information of the man page.

- **To access the `fbconfig` man page, type:**

```
# man fbconfig
```

- **To access the `SUNwifb_config` man page, type:**

```
# man SUNwifb_config
```

Installing the Sun XVR-500 Graphics Accelerator Hardware

This chapter provides Sun XVR-500 graphics accelerator hardware installation information.

- “Before Installation” on page 17
- “System Configurations” on page 18
- “Installing the Hardware” on page 19
- “Installing the Hardware in Sun Blade 1000 and 2000 Systems” on page 20
- “Configuring Multiple Frame Buffers” on page 21
- “Changing the Monitor Screen Resolution” on page 22

Before Installation

Refer to the *Solaris Handbook for Sun Peripherals* that corresponds to your operating environment. The handbook describes how to shut down the system safely before installing any internal boards and before rebooting your system after installation.

System Configurations

TABLE 3-1 shows the maximum number of Sun XVR-500 graphics accelerators supported in Sun systems.

Note – It is recommended that the Sun XVR-500 graphics accelerators be installed in the system 66-Mhz PCI connector slots, if 66-Mhz PCI slots are available on your system.

TABLE 3-1 Supported Number of Sun XVR-500 Graphics Accelerators

Sun System	Maximum Number of Devices Supported
Sun Blade 150 system	2
Sun Blade 1000 system	4
Sun Blade 2000 system	4
Sun Fire V480 server	3
Sun Fire V880 server	4

Note – The Sun Fire V880 server requires the Sun Fire V880 I/O board 501-5142-12 or higher. Factory-shipped 900 MHz Sun Fire V880 servers have this revision level of I/O boards. For earlier Sun Fire V880 servers, you will need to upgrade with I/O board 501-5142-12 or higher.

Installing the Hardware

Refer to the following hardware documentation provided with your Sun system for detailed instructions on installing Sun PCI bus graphics boards:

- *Sun Blade 150 Service Manual (816-4379)*
- *Sun Blade 1000 and Sun Blade 2000 Service Manual (816-3217)*
- *Sun Fire V480 Server Parts Installation and Removal Guide (816-0907)*
- *Sun Fire V880 Server Service Manual (806-6597)*

Access this documentation at: <http://www.sun.com/documentation>

Note – The Sun XVR-500 graphics accelerator contains an ASIC heatsink (FIGURE 3-1) that you may notice to have a spring motion. This is designed to help protect the ASIC.

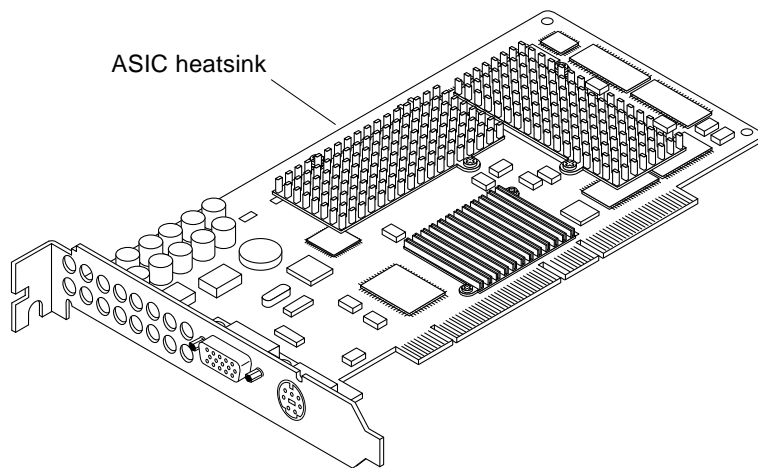

FIGURE 3-1 Sun XVR-500 Graphics Accelerator ASIC Heatsink

Installing the Hardware in Sun Blade 1000 and 2000 Systems

The Sun XVR-500 graphics accelerator connects into the 66-Mhz or 33-Mhz PCI connectors on the Sun Blade 1000 and 2000 motherboard. The PCI slots are labelled on the Sun Blade 1000 and 2000 backpanel. The Sun Blade 1000 and 2000 systems support up to four Sun XVR-500 graphics accelerators.

Note – It is recommended that you use the 66-Mhz PCI slots in a Sun Blade 1000 or 2000 system.

1. **Shut down your system and attach the antistatic wrist strap.**
2. **Remove the Sun Blade 1000 or 2000 access panel and lay the system on its side.**
3. **Position the Sun XVR-500 graphics accelerator in the chassis (FIGURE 3-2).**
4. **Guide the graphics board bracket tab into the chassis backpanel opening.**

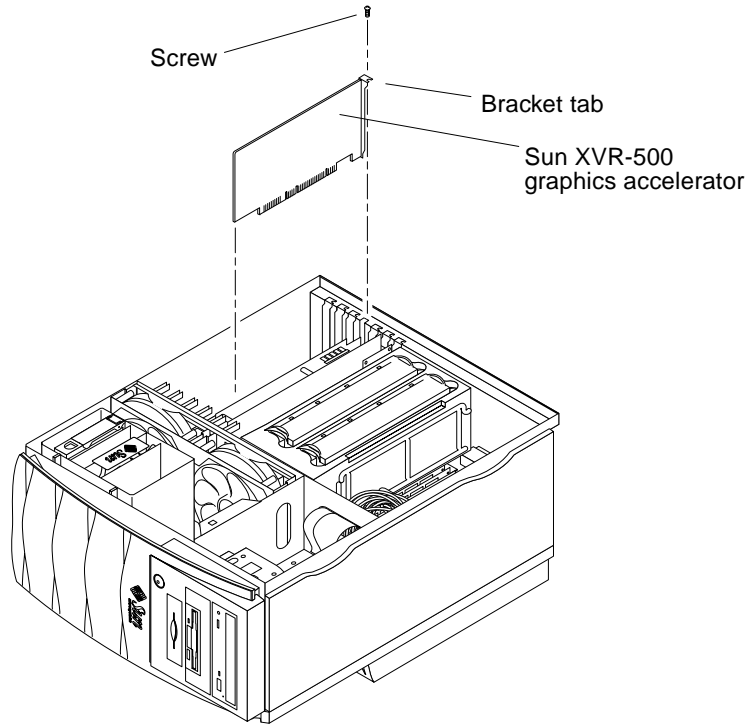

FIGURE 3-2 Installing Sun XVR-500 Graphics Accelerator in a Sun Blade 1000/2000 System

5. Holding the two upper corners of the graphics board, push the board straight down into the connector until the board is fully seated.
6. Replace the Phillips screw securing the graphics board bracket tab to the system chassis.
7. Replace the side access cover.

Configuring Multiple Frame Buffers

To run more than one frame buffer, you must modify your `/etc/dt/config/Xservers` file. The Sun XVR-500 graphics accelerator device is identified as `ifbx` (for example, `ifb0` and `ifb1` for two Sun XVR-500 graphics accelerator devices). To modify the file:

1. Become superuser and open the `/etc/dt/config/Xservers` file.

```
# cd /etc/dt/config
# vi Xservers
```

If the `/etc/dt/config/Xservers` file does not exist, create the `/etc/dt/config` directory and copy the `Xservers` file from `/usr/dt/config/Xservers` to `/etc/dt/config`.

```
# mkdir -p /etc/dt/config
# cp /usr/dt/config/Xservers /etc/dt/config
# cd /etc/dt/config
# vi Xservers
```

2. Modify the file by adding the device locations for the applicable frame buffers being used.

The following example shows the `Xservers` configuration file modified for one Sun Creator board and two Sun XVR-500 graphics accelerators:

```
:0 Local local_uid@console root /usr/openwin/bin/Xsun -dev /dev/fbs/ffb0
-dev /dev/fbs/ifb1 -dev /dev/fbs/ifb0
```

Changing the Monitor Screen Resolution

For most installations, the Sun XVR-500 graphics accelerator automatically configures itself to the proper screen resolution and refresh rate for your monitor. If a Sun monitor, however, is not connected to the Sun XVR-500 graphics accelerator, the monitor may have the wrong screen resolution. To change the screen resolution, use the `fbconfig` utility.

Sun XVR-500 Graphics Accelerator Frame Locking

This chapter describes Sun XVR-500 graphics accelerator frame locking.

- “Sun XVR-500 Graphics Accelerator Frame Lock System” on page 23
- “Configuring Sun XVR-500 Graphics Accelerators for Frame Locking” on page 25
- “Frame Lock Cable Assembly” on page 27
- “Connecting the Frame Lock Cable Assembly” on page 28

Sun XVR-500 Graphics Accelerator Frame Lock System

The frame lock synchronization feature enables vertical retracing to occur simultaneously on each Sun XVR-500 graphics accelerator subsystem. The frame lock cable assembly is used to daisy-chain two or more Sun XVR-500 graphics accelerator subsystems. Vertical retrace synchronization eliminates flicker between multiscreen displays.

Frame locking is often necessary when running in stereo in a multihead environment. All the displays can be synchronized so that the left and right views can be seen correctly through one set of LCD stereo glasses.

When frame buffers are frame locked, you should make sure they are all running at the same video resolution and vertical retrace rate (see `fbconfig -help` for details). See “Configuring Sun XVR-500 Graphics Accelerators for Frame Locking” on page 25.

To use the frame lock features, the frame lock cable assembly is required. See “Frame Lock Cable Assembly” on page 27 for installation.

To order the frame lock cable assembly, call Sun Telesales at 1-800-786-0404 and request spare part number 530-2754. You can also order the frame lock cable assembly through the Sun store (<http://store.sun.com>) by ordering this part number under spare parts.

By default, two channels are *not* frame locked.

Supported Systems

TABLE 4-1 lists the supported systems for frame locking and lists the supported number of devices for each system.

TABLE 4-1 Supported Systems

Sun system	Maximum number of devices supported
Sun Blade 1000 system	4
Sun Blade 2000 system	4
Sun Fire 480 server	3
Sun Fire 880 server	4

Configuring Sun XVR-500 Graphics Accelerators for Frame Locking

1. **Designate a Sun XVR-500 graphics accelerator as master for the graphics boards to be in frame lock.**

You can use the Sun XVR-500 graphics accelerator that serves as the boot/console head for that system.

Refer to the `boot -r` man page for device location and device numbering information for how devices are numbered based on their physical location. For frame lock, you may select any device (that is, `ifb0`, `ifb1`, `ifb2`,...and so on) to be the master Sun XVR-500 graphics accelerator device.

2. **Make sure that each Sun XVR-500 graphics accelerator installed has the same monitor resolution as the one in master mode.**

- a. **Check the resolution of an Sun XVR-500 graphics accelerator by using the `fbconfig` command. For example:**

```
% fbconfig -dev /dev/fbs/ifb0 -prconf
```

You must repeat this command for each Sun XVR-500 graphics accelerator in the system or systems.

The `fbconfig` command displays the current monitor resolution setting. It also displays additional information such as whether the Sun XVR-500 graphics accelerator is a master or slave.

- b. **(Optional) Change the resolution of a Sun XVR-500 graphics accelerator using the `fbconfig` command.**

If the resolution on each Sun XVR-500 graphics accelerator is not the same, you must change it to match the Sun XVR-500 graphics accelerator in master mode. For example:

```
% fbconfig -dev /dev/fbs/ifb1 -res 1280x1024x76 now nocheck
```

If the resolution on each Sun XVR-500 graphics accelerator is not the same, you must change it to match the Sun XVR-500 graphics accelerator in master mode.

3. Connect the frame lock cable to each Sun XVR-500 graphics accelerator.

Make sure to first connect the top of the frame lock cable assembly to the master Sun XVR-500 graphics accelerator.

See the section “Frame Lock Cable Assembly” on page 27.

4. From the master Sun XVR-500 graphics accelerator display window, configure the other Sun XVR-500 graphics accelerators in slave mode.

Use the `fbconfig` command. For example:

```
% fbconfig -dev /dev/fbs/ifb1 -slave enable
```

You must configure each board separately (that is, for `ifb1`, `ifb2`, `ifb3`, and so on).

Your system is now ready for frame locking.

To reconfigure your Sun XVR-500 graphics accelerator from slave mode back to master mode, use the `fbconfig` command. For example:

```
% fbconfig -dev /dev/fbs/ifb1 -slave disable
```

Frame Lock Cable Assembly

The frame lock cable assembly, FIGURE 4-1, is a Y-shaped cable assembly with three connectors for daisy-chaining multiple Sun XVR-500 graphics accelerator within a computer system. (See Appendix A, “Stereo Output Port” on page 33, for the stereo connector pinout signals.)

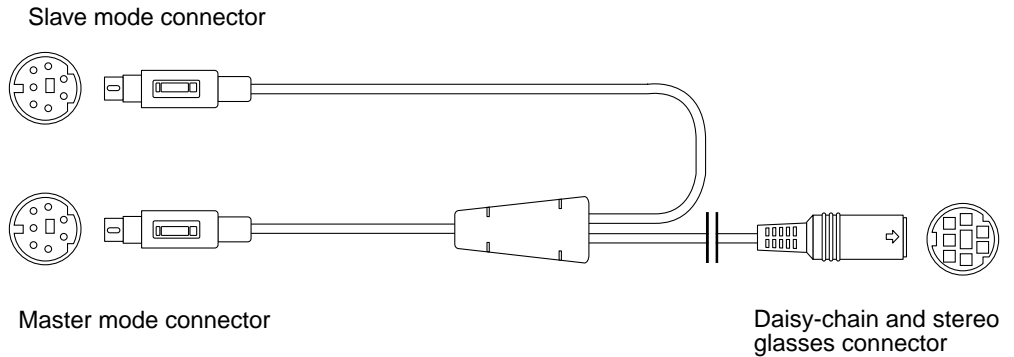

FIGURE 4-1 Frame Lock Cable Assembly

TABLE 4-2 Frame Lock Cable Connections

Frame Lock Connector	Description
Master connector (shortest cable-male)	Connects into the stereo connector located on the Sun XVR-500 graphics accelerator that is designated as the master device. It also plugs into the daisy-chain connector for slave Sun XVR-500 graphics accelerators.
Slave connector (longest cable male)	Connects into the stereo connector located on the Sun XVR-500 graphics accelerator that is designated as a slave device.
Daisy chain/stereo glasses connector (female connector)	Can connect a pair of stereo glasses directly into this connector or the connector can be used to daisy chain to other frame lock cables for slave Sun XVR-500 graphics accelerator devices.

Note – There can only be one master Sun XVR-500 graphics accelerator device. You must configure all other Sun XVR-500 graphics accelerator devices as slaves. See the section “Configuring Sun XVR-500 Graphics Accelerators for Frame Locking” on page 25.

Connecting the Frame Lock Cable Assembly

- 1. Locate the master Sun XVR-500 graphics accelerator I/O backplate on the rear of your system and connect the top of the frame lock cable assembly stereo connector.**
- 2. Connect the slave cable connector to a slave Sun XVR-500 graphics accelerator stereo connector.**
- 3. Connect a second slave Sun XVR-500 graphics accelerator, if applicable, or stereo glasses to the daisy-chain/stereo connector (FIGURE 4-2).**

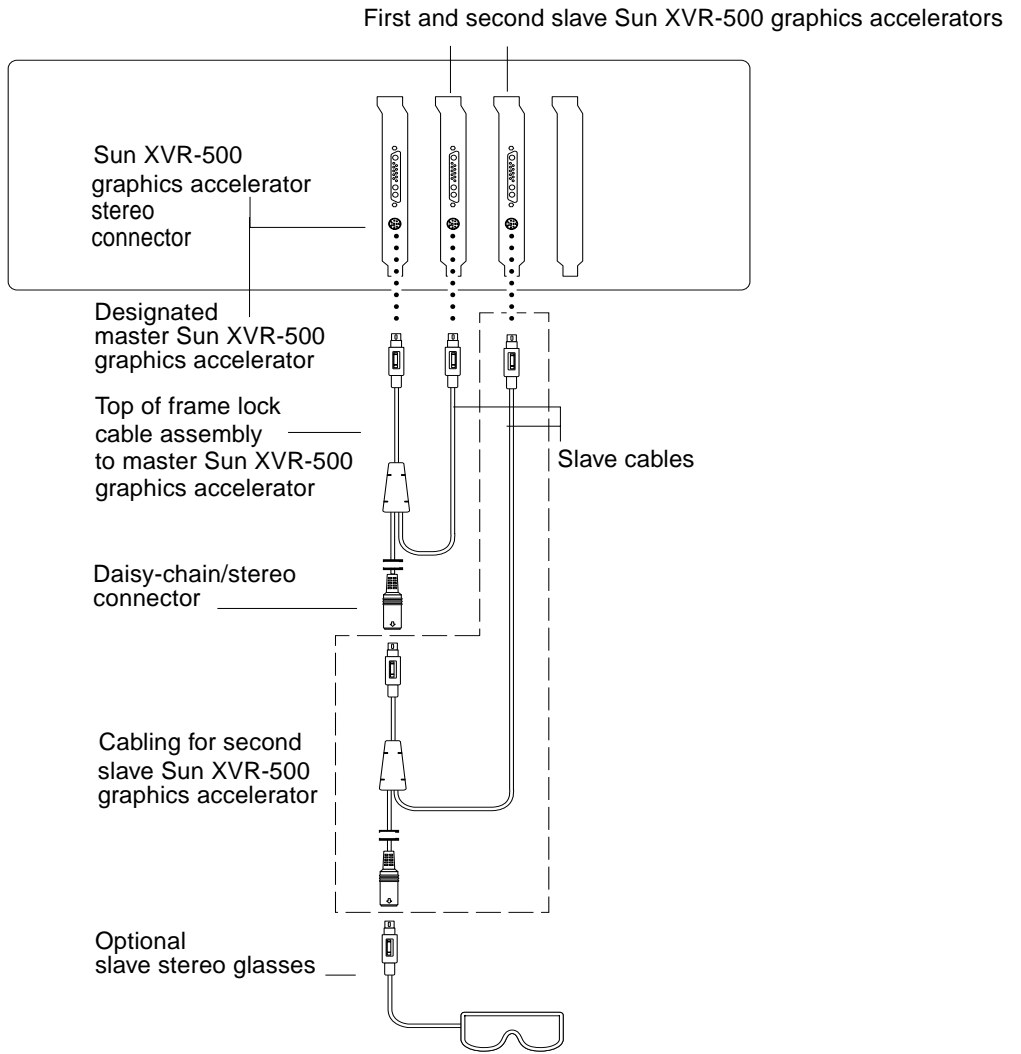

FIGURE 4-2 Sun XVR-500 Graphics Accelerator and Frame Lock Cable Assembly

Sun XVR-500 Graphics Accelerator Specifications

This appendix provides I/O port specifications for the Sun XVR-500 graphics accelerator.

- “I/O Port Specifications” on page 31
- “Screen Resolutions and Video Formats” on page 34
- “Accessing Field Replaceable Unit Information” on page 35

I/O Port Specifications

The external I/O ports are accessible through the I/O connectors on the Sun XVR-500 graphics accelerator backplate (FIGURE A-1).

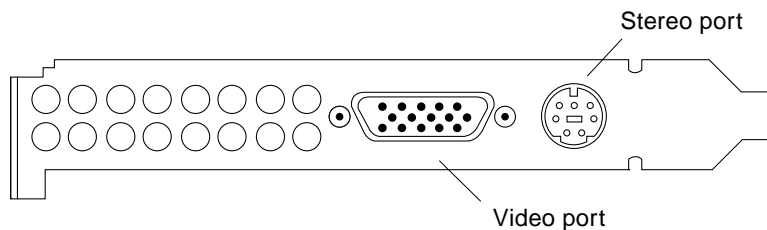

FIGURE A-1 Sun XVR-500 Graphics Accelerator I/O Connectors

The Sun XVR-500 graphics accelerator has the following external I/O ports:

- Video output port
- Stereo output port

Video Output Port

The video output port is a HD15 15-pin connector that connects the workstation monitor.

The video connector supports DDC2 monitor support and Display Power Management Signaling (DPMS).

TABLE A-1 Sun XVR-500 Graphics Accelerator HD15 Video Output Port

Pin	Signal
1	Red analog video
2	Green analog video
3	Blue analog video
4	No Connect
5	Ground
6	Ground
7	Ground
8	Ground
9	+5V Supply
10	Ground
11	No Connect
12	DDC Bidirectional Data (SDA)
13	Horizontal/Composite Sync
14	Vertical Sync
15	DDC Data Clock (SCL)

Stereo Output Port

FIGURE A-2 and TABLE A-3 shows the Sun XVR-500 graphics accelerator stereo connector and pinout signals.

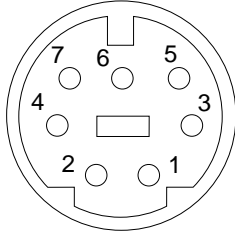

FIGURE A-2 Sun XVR-500 Graphics Accelerator 7-Pin DIN Female Stereo Connector

TABLE A-2 Sun XVR-500 Graphics Accelerator Stereo Connector Pinout

Pin	Signal
1	Signal ground
2	5.0V (Fused, will supply up to 300mA, limited to 1.0A)
3	12.0V (Fused, will supply up to 300mA, limited to 1.0A)
4	Master stereo field Select Out
5	Slave stereo field Select In
6	No connect
7	No connect

Screen Resolutions and Video Formats

TABLE A-3 lists the monitor screen resolutions and video formats supported by the Sun XVR-500 graphics accelerator:

TABLE A-3 Sun XVR-500 Graphics Accelerator Monitor Screen Resolutions

Display Resolution	Vertical Refresh Rate	Sync Standard	Aspect Ratio Format
1920 x 1080	72 Hz	Sun	16:9
1600 x 1280	76 Hz	Sun	5:4
1600 x 1200	75 Hz	VESA	4:3
1600 x 1000	66, 76 Hz	Sun	16:10
1440 x 900	76 Hz	Sun	16:10
1280 x 800	112Hz	Sun-stereo	16:10
1280 x 800	76 Hz	Sun	16:10
1280 x 1024	60, 75, 85 Hz	VESA	5:4
1280 x 1024	67, 76 Hz	Sun	5:4
1152 x 900	112, 120 Hz	Sun-stereo	5:4
1152 x 900	66, 76 Hz	Sun	5:4
1024 x 800	84 Hz	Sun	5:4
1024 x 768	75 Hz	VESA	4:3
1024 x 768	60, 70, 77 Hz	Sun	4:3
960 x 680	108, 112 Hz	Sun-stereo	Sun-Stereo
768 x 575	50i Hz	PAL	PAL
640 x 480	60 Hz	VESA	4:3
640 x 480	60i Hz	NTSC	NTSC

Note – The 640 x 480 resolutions support Sun OpenGL for Solaris multisampling capable of two samples per pixel. You can find configuration details with `fbconfig -help`, `/usr/lib/fbconfig/SUNwifb_config -help`, or in the `SUNwifb_config` man page (see “Man Pages” on page 15).

Accessing Field Replaceable Unit Information

The Sun XVR-500 graphics accelerator features a system for identifying the board by means of a FRU ID (field replaceable unit identifier). This information is contained on a PROM chip mounted on the Sun XVR-500 graphics accelerator.

A FRU ID allows you to identify the Sun XVR-500 graphics accelerator serial number and other data using `fbconfig`.

- **To obtain FRU ID information, type:**

```
% fbconfig -dev ifb0 -prconf
--- Hardware Configuration for /dev/fbs/ifb7 ---
Type: XVR-500 (Expert3D-Lite compatible)
Hardware Revision: -01 rev50
Sun Serial Number: 3753069005783
Manufacture Date: Tue Jul 02 10:01:00 2002
PROM Information: @(#)ifb.fth 1.65 01/04/06 SMI
EDID Data: Available - EDID version 1 revision 1
Monitor type: Sun P/N 365-1383 S/N 9906KN4883
Monitor possible resolutions: 1024x768x60, 1024x768x70,
1024x768x75,
1152x900x66, 1152x900x76, 1280x1024x67, 1280x1024x75,
1280x1024x76,
960x680x112s, 640x480x60, 1600x1200x75
Current resolution setting: 1280x1024x75
Slave Mode: Disabled
Video Memory Total: 33554432
Video Memory Used: 20971520
Texture Memory Total: 16777216
Texture Memory Used: 4096
Display List Memory Total: 16777216
```

Setting the Default Console Display for the Sun Blade 1000 and 2000 Systems

These instructions describe how to set the Sun XVR-500 graphics accelerator as the default monitor console display for Sun Blade 1000 and Sun Blade 2000 systems only.

1. At the `ok` prompt, type:

```
ok show-displays
```

Information similar to the text below will be displayed:

```
a) /pci@1f,0/SUNW,m64B@13
b) /pci@1f,0/pci@5/SUNW,XVR-500@1
q) NO SELECTION
Enter Selection, q to quit: b
/pci@1f,0/pci@5/SUNW,XVR-500@1 has been selected.
Type ^Y ( Control-Y ) to insert it in the command line.
e.g. ok nvalias mydev ^Y
    for creating devalias mydev for
/pci@1f,0/pci@5/SUNW,XVR-500@1
ok nvalias mydev /pci@1f,0/pci@5/SUNW,XVR-500@1
ok setenv output-device mydev
output-device = mydev
```

2. Select the graphics board you want to be the default console display.

In the above example, you type **b** for the Sun XVR-500 graphics accelerator.

3. Create an alias name for the Sun XVR-500 device:

This step is optional for all other systems. Creating the alias, however, will simplify future OpenBoot™ PROM commands.

a. Select the Sun XVR-500 graphics accelerator device from the `show-displays` menu.

b. Name the Sun XVR-500 graphics accelerator device.

i. Use `nvalias` to name the device.

This example shows `mydev` as the device.

```
ok nvalias mydev
```

ii. Press Control-Y on your keyboard and then Enter.

c. Verify the alias.

```
ok devalias
```

The selected alias is then displayed.

You can now refer to `mydev` for the Sun XVR-500 graphics accelerator device. For example,

```
ok setenv output-device mydev
```

4. Reset the output-device environment:

```
ok reset-all
```

5. Connect your monitor cable to the Sun XVR-500 graphics accelerator on your system back panel.