



Solaris™ Handbook for Sun™ Frame Buffers

Sun Microsystems, Inc.
901 San Antonio Road
Palo Alto, CA 94303-4900 U.S.A.
650-960-1300

Part No. 806-6054-10
October 2000, Revision A

Send comments about this document to: docfeedback@sun.com

Copyright 2000 Sun Microsystems, Inc., 901 San Antonio Road, Palo Alto, CA 94303-4900 U.S.A. All rights reserved.

This release includes Sun Expert3D and Expert3D-Lite graphics accelerators.

This product or document is distributed under licenses restricting its use, copying, distribution, and decompilation. No part of this product or document may be reproduced in any form by any means without prior written authorization of Sun and its licensors, if any. Third-party software, including font technology, is copyrighted and licensed from Sun suppliers.

Parts of the product may be derived from Berkeley BSD systems, licensed from the University of California. UNIX is a registered trademark in the U.S. and other countries, exclusively licensed through X/Open Company, Ltd.

Sun, Sun Microsystems, the Sun logo, AnswerBook2, docs.sun.com, and Solaris are trademarks, registered trademarks, or service marks of Sun Microsystems, Inc. in the U.S. and other countries. All SPARC trademarks are used under license and are trademarks or registered trademarks of SPARC International, Inc. in the U.S. and other countries. Products bearing SPARC trademarks are based upon an architecture developed by Sun Microsystems, Inc.

The OPEN LOOK and Sun™ Graphical User Interface was developed by Sun Microsystems, Inc. for its users and licensees. Sun acknowledges the pioneering efforts of Xerox in researching and developing the concept of visual or graphical user interfaces for the computer industry. Sun holds a non-exclusive license from Xerox to the Xerox Graphical User Interface, which license also covers Sun's licensees who implement OPEN LOOK GUIs and otherwise comply with Sun's written license agreements.

Federal Acquisitions: Commercial Software—Government Users Subject to Standard License Terms and Conditions.

DOCUMENTATION IS PROVIDED "AS IS" AND ALL EXPRESS OR IMPLIED CONDITIONS, REPRESENTATIONS AND WARRANTIES, INCLUDING ANY IMPLIED WARRANTY OF MERCHANTABILITY, FITNESS FOR A PARTICULAR PURPOSE OR NON-INFRINGEMENT, ARE DISCLAIMED, EXCEPT TO THE EXTENT THAT SUCH DISCLAIMERS ARE HELD TO BE LEGALLY INVALID.

Copyright 2000 Sun Microsystems, Inc., 901 San Antonio Road, Palo Alto, CA 94303-4900 Etats-Unis. Tous droits réservés.

Ce produit ou document est distribué avec des licences qui en restreignent l'utilisation, la copie, la distribution, et la décompilation. Aucune partie de ce produit ou document ne peut être reproduite sous aucune forme, par quelque moyen que ce soit, sans l'autorisation préalable et écrite de Sun et de ses bailleurs de licence, s'il y en a. Le logiciel détenu par des tiers, et qui comprend la technologie relative aux polices de caractères, est protégé par un copyright et licencié par des fournisseurs de Sun.

Des parties de ce produit pourront être dérivées des systèmes Berkeley BSD licenciés par l'Université de Californie. UNIX est une marque déposée aux Etats-Unis et dans d'autres pays et licenciée exclusivement par X/Open Company, Ltd.

Sun, Sun Microsystems, le logo Sun, AnswerBook2, docs.sun.com, et Solaris sont des marques de fabrique ou des marques déposées, ou marques de service, de Sun Microsystems, Inc. aux Etats-Unis et dans d'autres pays. Toutes les marques SPARC sont utilisées sous licence et sont des marques de fabrique ou des marques déposées de SPARC International, Inc. aux Etats-Unis et dans d'autres pays. Les produits portant les marques SPARC sont basés sur une architecture développée par Sun Microsystems, Inc.

L'interface d'utilisation graphique OPEN LOOK et Sun™ a été développée par Sun Microsystems, Inc. pour ses utilisateurs et licenciés. Sun reconnaît les efforts de pionniers de Xerox pour la recherche et le développement du concept des interfaces d'utilisation visuelle ou graphique pour l'industrie de l'informatique. Sun détient une licence non exclusive de Xerox sur l'interface d'utilisation graphique Xerox, cette licence couvrant également les licenciés de Sun qui mettent en place l'interface d'utilisation graphique OPEN LOOK et qui en outre se conforment aux licences écrites de Sun.

LA DOCUMENTATION EST FOURNIE "EN L'ETAT" ET TOUTES AUTRES CONDITIONS, DECLARATIONS ET GARANTIES EXPRESSES OU TACITES SONT FORMELLEMENT EXCLUES, DANS LA MESURE AUTORISEE PAR LA LOI APPLICABLE, Y COMPRIS NOTAMMENT TOUTE GARANTIE IMPLICITE RELATIVE A LA QUALITE MARCHANDE, A L'APTITUDE A UNE UTILISATION PARTICULIERE OU A L'ABSENCE DE CONTREFAÇON.

Hardware: Workstations & Servers



Adobe PostScript

Contents

Preface	11
1. TurboGXplus Frame Buffer	15
TurboGXplus-supported Monitors	15
Default Screen Resolutions	17
Programming the Screen Resolution	17
2. Creator Graphics Accelerator	23
Default Screen Resolutions	24
Supported Screen Resolutions	25
Changing Screen Resolutions (-res)	26
Changing Screen Visuals List	28
Creator Series 3 Options	31
Impact on Screen Visual List by Various <code>ffbconfig</code> Visual Flags	33
Stereo Connector	36
3. The Creator Window System	39
Creator Visuals	40
Hardware Color LUT Usage	45
Reducing Colormap Flashing	45
Hardware Window IDs	47

Cursor Management	48
Hardware Double Buffering	49
Device Configuration	49
Performance Notes	50
4. XIL Acceleration on the Creator Graphics Accelerator	53
XIL Data Types	53
Accelerated Functions	54
Double Buffer Support	57
5. PGX Graphics Accelerator	61
Supported Screen Resolutions	62
Changing the Screen Resolution Temporarily	63
Printing the PGX Hardware Configuration	64
For More Information	65
PEX Library Bug Workaround	65
6. PGX32 Graphics Accelerator	67
Interactive Configuration	67
Noninteractive Configuration	69
Other Methods for Changing the Screen Resolution	70
Setting PGX32 as the Console (Optional)	75
Starting the Desktop Environment	78
Using <code>nvedit</code> to Modify NVRAM	80
7. Elite3D Graphics Accelerator	83
Default Screen Resolutions	84
Supported Screen Resolutions	84
Changing Screen Resolutions (<code>-res</code>)	86
Changing Screen Visuals List	87
Impact on Screen Visual List by Various <code>afbconfig</code> Visual Flags	92

	Stereo Connector	95
8.	Expert3D Graphics Accelerator	99
	Configuration Utilities	99
	Default Screen Resolutions	100
	Supported Screen Resolutions	101
	Changing Screen Resolutions (-res)	102
	Changing Screen Visuals List	104
	Setting Gamma Correction (-g, -gfile)	107
	Choosing Extended Overlay (-extovl)	108
	Multiple Monitor Configuration	108
	Defining the Expert3D Card as the Default Console	109
	Expert3D External I/O Connectors	111
9.	Multiple Monitors on a System	117
	Multiple Monitor Configuration	117
	Device File Names	119
	Checking the Available Frame Buffers	119
	Starting OpenWindows from the Console	120
	Running OpenWindows on Multiple Monitors	121
	Changing the Polling Order	122

Figures

FIGURE 2-1	Creator Series 1 Stereo Connector	36
FIGURE 2-2	Creator Series 2 and Series 3 Stereo Connector	37
FIGURE 2-3	Creator Stereo Signal	38
FIGURE 3-1	The 11 Creator Accelerator Visuals	41
FIGURE 4-1	Creator Depth-cueing	56
FIGURE 6-1	PGX32 Configuration Window	68
FIGURE 7-1	Elite3D Stereo Connector	96
FIGURE 7-2	Elite3D Stereo Signal	97
FIGURE 8-1	Expert3D External I/O Port Connectors	111
FIGURE 8-2	Expert3D-Lite External I/O Port Connectors	112
FIGURE 8-3	Expert3D Stereo Connector	112
FIGURE 8-4	Expert3D Stereo Signal	113
FIGURE 8-5	Expert3D Multiview In and Multiview Out Connectors	114
FIGURE 9-1	SBus Probe List Explanation	124

Tables

TABLE 1-2	TurboGXplus Monitor Sense Codes	17
TABLE 2-1	Creator Graphics Accelerator Monitor Sense Codes	24
TABLE 2-3	Solaris Patches for Creator Monitor Synchronization	26
TABLE 2-4	The Default Settings of the <code>ffbconfig</code> Visual Flags	28
TABLE 2-5	Creator Series 2 and Series 3 Stereo Connector Signals	37
TABLE 4-1	Accelerated XIL Functions	54
TABLE 5-1	PGX-supported Screen Resolutions	62
TABLE 5-2	PGX-screen Resolution Formats	63
TABLE 6-1	PGX32 Configuration Window	68
TABLE 6-2	Noninteractive Configuration Parameters	69
TABLE 6-3	PGX32 Screen Resolutions	72
TABLE 6-4	Sync Values	75
TABLE 6-5	NVRAM Editor	80
TABLE 7-1	Elite 3D Graphics Accelerator Monitor Sense Codes	84
TABLE 7-2	Elite 3D-supported Screen Resolutions	84

TABLE 7-3	Solaris Patches for Elite3D Monitor Synchronization	85
TABLE 7-4	The Default Settings of the <code>afbconfig</code> Visual Flags	87
TABLE 7-5	Default Settings for <code>afbconfig -extovl</code> Options	91
TABLE 7-6	Default Settings for <code>afbconfig -maxwids</code> Options	92
TABLE 7-7	Elite3D Stereo Connector Signals	96
TABLE 8-1	Expert3D Graphics Accelerator Monitor Sense Codes	101
TABLE 8-2	Expert3D-supported Screen Resolutions	101
TABLE 8-3	The Default Settings of the <code>SUNwifb_config</code> Visual Flags	104
TABLE 8-4	Expert3D Stereo Connector Signals	112

Preface

The *Solaris Handbook for Sun Frame Buffers* contains important information on configuration options for the various frame buffers. The frame buffer devices described in this document are:

- TurboGXplus™ Frame Buffer
- Creator and Creator 3D Graphics Accelerators
- PGX Graphics Accelerator
- PGX32 Graphics Accelerator
- Elite3D Graphics Accelerator
- Expert3D, Expert3D-Lite Graphics Accelerator

This book is intended for anyone who needs to configure one of the described frame buffers or graphics accelerators to meet specific video or graphics requirements.

How This Book Is Organized

This book consists of the following chapters:

Chapter 1 describes how to configure a system using a TurboGXplus card to suit different screen resolutions and to support multiple monitors.

Chapter 2 describes the use of the `ffbconfig` utility, which can be used to select configuration options for the Creator or Creator 3D Graphics Accelerator, the attached monitor, and the associated X11 screen.

Chapter 3 describes how the Solaris X11 window system works on the Creator and Creator 3D Graphics Accelerators.

Chapter 4 describes the XIL functions that are specific to the Creator and Creator 3D Graphics Accelerators.

Chapter 5 describes the use of the `m64config` utility to change the display resolution on the PGX Graphics Accelerator.

Chapter 6 describes the use of the `GFXconfig` command to change the display resolution on the PGX32 Graphics Accelerator.

Chapter 7 describes the use of the `afbconfig` utility, which can be used to select configuration options on the Elite3D Graphics Accelerator, the attached monitor, and the associated X11 screen.

Chapter 8 describes the use of the `ifbconfig` utility, which can be used to select configuration options for the Expert3D and Expert3D-Lite graphics accelerators, the attached monitor, and associated X11 screen.

Chapter 9 describes how to use multiple monitors on a Sun system.

Using UNIX Commands

This document may not contain information on basic UNIX® commands and procedures such as shutting down the system, booting the system, and configuring devices.

See one or more of the following for this information:

- *Solaris Handbook for Sun Peripherals*
- AnswerBook2™ online documentation for the Solaris™ software environment
- Other software documentation that you received with your system

Typographic Conventions

Typeface or Symbol	Meaning	Examples
AaBbCc123	The names of commands, files, and directories; on-screen computer output	Edit your <code>.login</code> file. Use <code>ls -a</code> to list all files. % You have mail.
AaBbCc123	What you type, when contrasted with on-screen computer output	% su Password:
<i>AaBbCc123</i>	Book titles, new words or terms, words to be emphasized	Read Chapter 6 in the <i>User's Guide</i> . These are called <i>class</i> options. You <i>must</i> be superuser to do this.
	Command-line variable; replace with a real name or value	To delete a file, type <code>rm filename</code> .

Shell Prompts

Shell	Prompt
C shell	<i>machine_name</i> %
C shell superuser	<i>machine_name</i> #
Bourne shell and Korn shell	\$
Bourne shell and Korn shell superuser	#

Accessing Sun Documentation Online

The `docs.sun.com`SM web site enables you to access Sun technical documentation on the Web. You can browse the `docs.sun.com` archive or search for a specific book title or subject at:

`http://docs.sun.com`

Sun Welcomes Your Comments

We are interested in improving our documentation and welcome your comments and suggestions. You can email your comments to us at:

`docfeedback@sun.com`

Please include the part number (806-3979-10) of your document in the subject line of your email.

Ordering Sun Documentation

Fatbrain.com, an Internet professional bookstore, stocks select product documentation from Sun Microsystems, Inc.

For a list of documents and how to order them, visit the Sun Documentation Center on Fatbrain.com at:

`http://www.fatbrain.com/documentation/sun`

TurboGXplus Frame Buffer

This chapter describes how you can configure your system using a TurboGXplus™ card to suit your specific video and graphics requirements. The information describes how to set up your TurboGXplus to support different screen resolutions and how to set up the system to support multiple monitors.

TurboGXplus-supported Monitors

TABLE 1-1 shows the list of monitors supported by the TurboGXplus card.

Note – The monitors listed in TABLE 1-1 are subject to change as Sun Microsystems announces new monitors. Contact your local Sun representative for a listing of supported monitors.

TABLE 1-1 Monitors Supported by TurboGXplus

Model	Sun Part Number	Type/Size/FCC	Monitor ID Sense Code	Standard Resolution and Refresh Rate
X248A	365-1068-01	Color 21"	2	1280 x 1024 at 76 Hz ¹
GDM-20D10	365-1167-01	Color 20"	4	1152 x 900 at 76 Hz ¹ 1152 x 900 at 66 Hz 1280 x 1024 at 67 Hz 1280 x 1024 at 76 Hz
GDM-1955A15	365-1081-01	Color 19"	3	1152 x 900 at 66 Hz
GDM-1962	365-1095-01	Color 19"	4	1152 x 900 at 76 Hz ¹ 1152 x 900 at 66 Hz 1280 x 1024 at 67 Hz

TABLE 1-1 Monitors Supported by TurboGXplus (*Continued*)

Model	Sun Part Number	Type/Size/FCC	Monitor ID Sense Code	Standard Resolution and Refresh Rate
GDM-1962B	365-1160-01	Color 19"	4	1152 x 900 at 76 Hz ¹ 1152 x 900 at 66 Hz 1280 x 1024 at 67 Hz
GDM-1604A15	365-1079-01	Color 16"	3	1152 x 900 at 66 Hz
GDM-1662B	365-11593-01	Color 16"	6	1152 x 900 at 76 Hz ¹ 1152 x 900 at 66 Hz
CPD-1790	365-1151-01	Color 16"	3	1152 x 900 at 66 Hz ¹ 1024 x 768 at 77 Hz
X449	365-1286-01	Color 15"	0	1024 x 768 at 77 Hz
GDM-20S5	365-1168-01	Greyscale 20"	2 or 4*	1280 x 1024 at 76 Hz) or 1152 x 900 at 76 Hz ² 1280 x 1024 at 67 Hz
17SMM4 A	365-1100-01	Grayscale 17"	6	1152 x 900 at 76 Hz
M20P110	365-1099-01	Grayscale 19"	4	1152 x 900 at 76 Hz
Non-Sun	--	Unknown	7	1152 x 900 at 66 Hz

1. The default resolution at power-on initialization.

2. Monitor ID sense code is user-selectable by the rear switch.

Default Screen Resolutions

TABLE 1-2 lists the default screen resolutions by monitor ID sense code.

TABLE 1-2 TurboGXplus Monitor Sense Codes

Code	Screen Resolution
7	1152 x 900 at 66 Hz
6	1152 x 900 at 76 Hz
5	1024 x 768 at 60 Hz
4	1152 x 900 at 76 Hz
3	1152 x 900 at 66 Hz
2	1280 x 1024 at 76 Hz
1	1600 x 1280 at 76 Hz
0	1024 x 768 at 77 Hz

Programming the Screen Resolution

Programming the screen resolution for TurboGXplus frame buffers must be done in `nvrामrc`, a nonvolatile PROM script memory. When the PROM reaches the device probing stage, it checks the `use-nvrामrc?` variable and if it is true, executes the Forth code that resides in `nvrामrc`. Otherwise, it calls `probe-sbus` (for all pre-Ultra systems) or `probe-all` (for all Ultra systems), `install-console`, and `banner`.

The following example places resolution initialization between the `probe-sbus` (or `probe-all`) stage and the `install-console` stage.

First `probe-sbus` or `probe-all` is called to probe all devices, so that the device tree is created, and the devices are initialized.

The next line defines a Forth word called `vsetup` which contains the monitor video setup values.

CODE EXAMPLE 1-1 Resolution Initialization Between probe-sbus and install-console Stage

```
#!/bin/sh
eeprom fcode-debug\?=true
eeprom use-nvramrc\?=true
eeprom nvramrc='probe-sbus          (or probe-all)
: vsetup " 117000000,71691,67,16,112,224,1280,2,8,33,1024,COLOR,0OFFSET" ;
vsetup 4
" /sbus/cgsix@1" " override" execute-device-method drop
install-console
banner
```

The following string of values (defined in CODE EXAMPLE 1-4) are the specifications for a video setup:

```
" 117000000,71691,67,16,112,224,1280,2,8,33,1024,COLOR,0OFFSET"
```

The line, `vsetup 4`, pushes the video string on the stack, the number 4 defines the sense code of the monitor to change the resolution on. See TABLE 1-3 for supported monitor codes. The number used should match the monitor attached to the TurboGXplus frame buffer.

The next line pushes the string `/sbus/cgsix@1` onto the Forth stack, the path for the device where the resolution is to be changed. The "1" in `cgsix@1` identifies the SBus slot number.

The following example changes the `cgsix` frame buffer on SBus slot 1.

```
ok nvedit
0: probe-sbus          (or probe-all)
1: : vsetup "
117000000,71691,67,16,112,224,1280,2,8,33,1024,COLOR,0OFFSET" ;
2: vsetup 4
3: " /sbus/cgsix@1" " override" execute-device-method drop
4: install-console
5: banner
6: ^C
ok nvstore
ok setenv use-nvramrc? true
ok setenv fcode-debug? true
```

The "override" string is the actual entry point in the cgsix fcode PROM that reconfigures the resolution from the data on the forth stack. execute-device-method actually calls override and returns a pass or fail flag, which is ignored by the drop command that follows.

The remaining two lines install-console and banner, installs a terminal driver on the display device, then prints the banner at reset time or reboot time.

Configuring Monitors Using a UNIX Script

The following is a UNIX script used to configure the TurboGXplus for a resolution of 1280 x 1024 at 67 Hz.

CODE EXAMPLE 1-2 UNIX Script Method

```
#!/bin/sh
eeprom fcode-debug\?=true
eeprom use-nvramrc\?=true
eeprom nvramrc='probe-sbus          (or probe-all)
: vsetup " 117000000,71691,67,16,112,224,1280,2,8,33,1024,COLOR,0OFFSET"
;vsetup 4
" /sbus/cgsix@1" " override" execute-device-method drop
install-console
banner
```

Configuring Monitors Using the PROM Method

The following example uses the PROM method to configure the TurboGXplus for a resolution of 1280 x 1024 at 67 Hz.

CODE EXAMPLE 1-3 PROM Method

```
ok nvedit
0: probe-sbus          (or probe-all)
1: : vsetup " 117000000,71691,67,16,112,224,1280,2,8,33,1024,COLOR,0OFFSET" ;
2: vsetup 4
3: " /sbus/cgsix@1" " override" execute-device-method drop
4: install-console
5: banner
6: ^C
ok nvstore
ok setenv use-nvramrc? true
ok setenv fcode-debug? true
```

TABLE 1-3 contains codes for TurboGXplus-supported resolutions:

TABLE 1-3 TurboGXplus Resolution Codes

Resolution	Code
1024 x 768 at 60 Hz	" 64125000,48286,60,16,128,160,1024,2,6,29,768,COLOR"
1024 x 768 at 70 Hz	" 74250000,56593,70,16,136,136,1024,2,6,32,768,COLOR"
1024 x 768 at 77 Hz	" 84375000,62040,77,32,128,176,1024,2,4,31,768,COLOR"
1152 x 900 at 66 Hz	" 94500000,61845,66,40,128,208,1152,2,4,31,900,COLOR"
1152 x 900 at 76 Hz	" 108000000,71808,76,32,128,192,1152,2,4,31,900,COLOR,0OFFSET"
1280 x 1024 at 67 Hz	" 117000000,71691,67,16,112,224,1280,2,8,33,1024,COLOR,0OFFSET"
1280 x 1024 at 76 Hz	" 135000000,81128,76,32,64,288,1280,2,8,32,1024,COLOR,0OFFSET"
1600 x 1280 at 76 Hz	" 216000000,101890,76,24,216,280,1600,2,8,50,1280,COLOR,0OFFSET"

Setting Up a Single Monitor Using the PROM Method

The following is an example of how to set up a TurboGXplus card in slot 2 to 1024 x 768 at 60 Hz using a 16-inch monitor.

CODE EXAMPLE 1-4 PROM Method for Single Monitor Setup

```
ok nvedit
0: probe-sbus                (or probe-all)
1: : vsetup " 64125000,48286,60,16,128,160,1024,2,6,29,768,COLOR"
;
2: vsetup 6
3: " /sbus/cgsix@2" " override" execute-device-method drop
4: install-console
5: banner
6: ^C
ok nvstore
ok setenv use-nvramrc? true
ok setenv fcode-debug? true
```

Setting Up a Single Monitor Using a UNIX Script

The following is a UNIX script that sets a 1024 x 768 at 60 Hz for the TurboGXplus card in slot 2.

CODE EXAMPLE 1-5 UNIX Script Method for Single Monitor Setup

```
#!/bin/sh
eeprom fcode-debug\?=true
eeprom nvramrc='probe-sbus          (or probe-all)
: vsetup " 64125000,48286,60,16,128,160,1024,2,6,29,768,COLOR" ;
vsetup 6
"/sbus/cgsix@2" " override" execute-device-method drop
install-console
banner
`
eeprom use-nvramrc\?=true
```

Setting Up Multiple Monitors Using a UNIX Script

The following example shows a UNIX script that sets up the TurboGXplus card in slot 1 to 1152 x 900 at 76 Hz, and another TurboGXplus card in slot 3 to 1280 x 1024 at 67 Hz using two 19-inch monitors.

CODE EXAMPLE 1-6 UNIX Script Method for Multiple Monitor Setup

```
#!/bin/sh
eeprom fcode-debug\?=true
eeprom nvramrc='probe-sbus          (or probe-all)
: vsetup1 " 108000000,71808,76,32,128,192,1152,2,4,31,900,COLOR,0OFFSET" ;
vsetup1 4
"/sbus/cgsix@1" " override" execute-device-method drop
: vsetup2 " 117000000,71691,67,16,112,224,1280,2,8,33,1024,COLOR,0OFFSET" ;
vsetup2 4
"/sbus/cgsix@3" " override" execute-device-method drop
install-console
banner
`
eeprom use-nvramrc\?=true
```

For more information on running multiple monitors, see Chapter 9.

Creator Graphics Accelerator

This chapter describes how to change the Creator and Creator 3D Graphics Accelerator screen resolution to work properly with different monitors.

The Creator Graphics Accelerator family consists of three different versions: Series 1, Series 2, and Series 3. The primary difference between each series is screen resolution, but there are other performance differences also. The Creator Series 1 is the base graphics accelerator in the family. The Creator Series 2 offers a performance improvement over the Series 1 and additional screen resolutions. The Creator Series 3 offers the highest performance and the largest number of screen resolutions, plus configurable gamma correction and extended overlay options.

You can change the Creator X11 screen and associated graphics hardware through the `ffbconfig` utility. Options are specified on the command line. The specified options are stored in the `OWconfig` file. You use these options to initialize the Creator device the next time Xsun is run on that device. Updating options in the `OWconfig` file provides persistence of these options across Xsun sessions and system reboots.

Note – `ffb` is the UNIX device name for the Creator family of graphics accelerators.

Use the `ffbconfig` utility to specify the following:

- Video mode (screen resolution and refresh rate)
- Type of visuals (linear or nonlinear)
- Whether to use 8-bit pseudocolor visual (overlay visual)
- Whether linear visuals will be reported before their nonlinear counterparts in the screen visuals list
- How to set the default screen visual
- How OpenGL visuals will be supported
- Whether Server Overlay Visuals (SOV) will be available
- The maximum number of Creator X channel pixels reserved for use as WIDs

- Whether the pseudocolor overlay visual will come before the pseudocolor underlay visual in the screen visuals list

For the Creator Series 3, the `ffbconfig` utility can be used to specify the following additional functions:

- Configurable gamma correction by specifying a gamma value or a file containing a gamma-correction table
- Extended overlay option enables a full 256-color overlay and hardware-accelerated transparency visuals

Default Screen Resolutions

The Creator system reads the VESA standard Extended Display Identification Data (EDID) from the monitor to determine the default screen resolution. If the EDID data is not available for the monitor, the monitor ID sense code is used to determine the default screen resolution.

TABLE 2-1 lists the default screen resolutions by monitor ID sense code.

TABLE 2-1 Creator Graphics Accelerator Monitor Sense Codes

Code	Screen Resolution
7	1152 x 900 at 66 Hz
6	1152 x 900 at 76 Hz
5	1024 x 768 at 60 Hz
4	1280 x 1024 at 67 Hz
3	1152 x 900 at 66 Hz
2	1280 x 1024 at 76 Hz
1	1152 x 900 at 66 Hz
0	1024 x 768 at 77Hz

If the Creator system is unable to determine the monitor type, such as for non-Sun monitors, it defaults to a resolution of 1152 x 900 at 66 Hz.

Supported Screen Resolutions

TABLE 2-2 lists the Creator-supported screen resolutions. Some resolutions are supported only on Creator3D Series 2 or later.

TABLE 2-2 Creator-supported Screen Resolutions

Screen Resolution	Vertical Refresh Rate	Description	Video Mode Format	Symbolic Name
1920 x 1200	70 Hz	Non-interlaced, Hi-Res, Creator 3D, Series 2,3	1920x1200x70	
1920 x 1080	72 Hz	Non-interlaced, Hi-Res, Creator 3D, Series 2, 3	1920x1080x72	
1920 x 1200	75 Hz	Non-interlaced, Hi-Res, only Creator 3D, Series 3	1920x1200x75	
1600 x 1280	76 Hz	Non-interlaced, Hi-Res, Creator 3D, Series 2,3	1600x1280x76	
1600 x 1000	76 Hz	Non-interlaced, Hi-Res, Creator 3D, Series 2,3	1600x1000x76	
1600 x 1000	66 Hz	Non-interlaced, Hi-Res, Creator 3D, Series 2,3	1600x1000x66	
1440 x 900	76 Hz	Non-interlaced, Hi-Res, Creator 3D, Series 2,3	1440x900x76	
1280 x 1024	76 Hz	Non-interlaced	1280x1024x76	1280
1280 x 1024	67 Hz	Non-interlaced	1280x1024x67	
1280 x 1024	60 Hz	Non-interlaced, Creator, Series 2,3	1280x1024x60	
1280 x 1024	85 Hz	Non-interlaced, Creator, Series 3	1280x1024x85	
1280 x 800	76 Hz	Non-interlaced, Creator, Series 2,3	1280x800x76	
1152 x 900	76 Hz	Non-interlaced	1152x900x76	1152
1152 x 900	66 Hz	Non-interlaced	1152x900x66	
1024 x 800	84 Hz	Non-interlaced	1024x800x84	
1024 x 768	77 Hz	Non-interlaced	1024x768x77	
1024 x 768	75 Hz	Non-interlaced, Creator 3D, Series 2,3	1024x768x75	
1024 x 768	70 Hz	Non-interlaced	1024x768x70	
1024 x 768	60 Hz	SVGA	1024x768x60	svga
960 x 680	112 Hz	Stereo, non-interlaced, 56 Hz field rate per eye	960x680x112s	stereo
960 x 680	108 Hz	Stereo, non-interlaced, 54 Hz field rate per eye	960x680x108s	
768 x 575	50 Hz	Interlaced – PAL	768x575x50i	pal
640 x 480	60 Hz	Interlaced – NTSC	640x480x60i	ntsc
640 x 480	60 Hz	Non-interlaced, Creator 3D, Series 2,3	640x480x60	

Some monitors may not support some the resolutions supported by the Creator system. You can get the list of resolutions supported by the Creator and the connected monitor using the `ffbconfig` command.

To assure monitor synchronization of supported resolutions, you must install the following Solaris patches before running `ffbconfig`. TABLE 2-3 lists the required patches:

TABLE 2-3 Solaris Patches for Creator Monitor Synchronization

Solaris Release	Patch
Solaris 2.5.1	105790-19
Solaris 2.6	105360-33
Solaris 2.7	
ffb patch	106145-16
xfb patch	106148-11
Solaris 8	N/A

Note – When the `ffb` and `xfb` patches are required, you must install both patches as a pair.

Changing Screen Resolutions (`-res`)

▼ To Find Resolutions Supported By Creator and the Connected Monitor

- Use the `ffbconfig` command as follows:

```
ffbconfig -res \?
```

You can change the screen resolution temporarily as a test to determine if the monitor supports the specified resolution.



Caution – Do not change screen resolution while the window system is running. Changing screen resolution while the window system is running may put the screen display in an unusable state.

▼ To Change Screen Resolutions Temporarily

- Use the `ffbconfig` command as follows:

```
ffbconfig -res video-mode try
```

See TABLE 2-2 for the list of *video-mode* options (see the “Video Mode Format” and “Symbolic Name” columns in the table). You will have five seconds to confirm the video mode by typing `y`.

▼ To Change the Screen Resolution to Stereo

- Enter the following:

```
ffbconfig -res stereo
```

This changes the resolution to 960 x 680 at 112 Hz stereo the next time Xsun is run.

Changing Screen Visuals List

The X server screen visuals list can be altered through `ffbconfig`. The `ffbconfig` options in TABLE 2-4 can be used to configure the list of the exported visuals for the specified device.

TABLE 2-4 The Default Settings of the `ffbconfig` Visual Flags

Name	Possible Values	Defaults in Solaris2.5.1/ 2.5.1 SHWP	Defaults in Solaris 2.6
<code>linearorder</code>	<code>first/last</code>	<code>last</code>	<code>last</code>
<code>deflinear</code>	<code>true/false</code>	<code>false</code>	<code>false</code>
<code>overlayorder</code>	<code>first/last</code>	<code>last</code>	<code>last</code>
<code>defoverlay</code>	<code>true/false</code>	<code>false</code>	<code>false</code>
<code>expvis</code>	<code>enable/disable</code>	<code>disable</code>	<code>enable</code>
<code>sov</code>	<code>enable/disable</code>	<code>disable</code>	<code>enable</code>

Changing the Visual List Order (`-linearorder`, `-overlayorder`)

By default, the nonlinear visual comes before the linear visual on the screen visual list. You can modify the order of the visual list by using the `ffbconfig` command.

Most 3D applications require a linear visual. Some 3D applications do not search for a linear visual using `XSolarisGetVisualGamma(3)`. Instead, these applications search the screen visual list for the first 24-bit TrueColor visual they find. To enable these applications to run with the correct visual, use the `-linearorder` option to change the visual list order so that the linear 24-bit TrueColor visual is the first one the application finds.

The desired visual ordering in the screen visuals list will be available whenever the window system is restarted.

- **To change the setting, enter the `ffbcfg` command with one of the `-linearorder` options.**

For example:

```
ffbcfg -linearorder first
```

By default, the 8-bit PseudoColor visual comes before the 8-bit PseudoColor Overlay visual on the screen visual list. You can modify the order of the visual list by using the `ffbcfg` command.

Some applications that use the 8-bit PseudoColor Overlay visual, search the visual list for the first 8-bit PseudoColor visual they find. To enable these applications to run with the correct visual, use the `-overlayorder` option to change the visual list order so that the 8-bit PseudoColor Overlay visual is the first 8-bit PseudoColor visual the application finds.

The desired visual ordering in the screen visuals list will be available whenever the window system is restarted.

- **To change the setting, enter the `ffbcfg` command with one of the `-overlayorder` options.**

For example:

```
ffbcfg -overlayorder first
```

Changing the Default Visual (`-deflinear`, `-defoverlay`)

By default, the 8-bit PseudoColor underlay visual is the default visual of the screen. The default visual can be changed to either a linear underlay visual or an overlay visual through `ffbcfg`.

- **To set the default visual to be a linear visual, enter the `ffbcfg` command as follows:**

```
ffbcfg -deflinear true
```

- To set the default visual to be an overlay visual, enter the `ffbconfig` command as follows:

```
ffbconfig -defoverlay true
```



Caution – Since there is no linear overlay visual, the user should not specify both “-deflinear true” and “-defoverlay true” simultaneously, or the result will be undefined.



Caution – Note that the visual ordering options (`overlayorder` and `linearorder`) are independent of the default visual options (`defoverlay` and `deflinear`). Moving the overlay visual groups, for example, to the front does not automatically make it a default visual. Some applications make this assumption and hence receive a “BADMATCH” X error when they try to match the colormap created by the default visual and the first 8-bit PseudoColor visual they can find.

Changing OpenGL Visual Support (`-expvis`)

Solaris 2.5.1 SHWP supports the OpenGL visual expansion. With visual expansion, five visual groups: the 8-bit PseudoColor, 24-bit TrueColor (Linear and Non-Linear), 24-bit DirectColor, and 8-bit PseudoColor Overlay, are expanded from a single visual to multiple visual instances of the same visual type. Different instances of the same visual groups represent different GLX capabilities (e.g. single-buffer or double-buffer capable, monoscopic or stereoscopic capable, or a combination of both). The number of visual instances depends on whether the X server is started in monoscopic or stereoscopic mode, and also whether the device is a Creator or Creator 3D.

▼ To Activate OpenGL Visual Support (Visual Expansion)

- Enter the following:

```
ffbconfig -expvis enable
```

Changing SERVER_OVERLAY_VISUALS Support (-sov)

SERVER_OVERLAY_VISUALS is one of the root window's properties that contains the visual ID, transparent type, transparent value, and layer of the server overlay visuals (SOV) of the screen. You can toggle the advertisement of this property and the export of the transparent server overlay visuals using `ffbconfig`.

▼ To Advertise SERVER_OVERLAY_PROPERTY and Export SOV

- Enter the following:

```
ffbconfig -sov enable
```

Creator Series 3 Options

The following options apply only to the Creator Series 3 Graphics Accelerator.

Setting Gamma Correction (-g, -gfile)

Gamma correction may be set by specifying a gamma correction value or by specifying a file that contains a gamma table.

The `-g` option will set the gamma table entries based on the gamma value specified. A gamma value of 2.22 represents linear gamma correction and matches the fixed value on the Creator and Creator 3D products. This value is a per-screen value and therefore all gamma corrected or linear visuals will use this value.

▼ To Set the Gamma Correction Using a Value

- Enter the following:

```
ffbconfig -g 2.22
```

The `-gfile` option will set the gamma table entries explicitly from a file containing three columns of 256 integers ranging from 0 to 255. The format is three integers separated by a newline character. Each line contains the RGB value to be put in the table for that entry. This value is a per-screen value and therefore all gamma-corrected or linear visuals will use this value.

▼ To Set the Gamma Correction Using a File

- Enter the following:

```
ffbconfig -gfile filename
```

Choosing Extended Overlay (`-extovl`)

Enabling the extended overlay option will switch the Series 3 Creator 3D from the standard overlay mode supported on series 1 or 2 to the new extended overlay functionality supported on Series 3. The extended overlay mode enables full 256-color overlays and hardware-accelerated Server Overlay Visuals. The maximum number of underlay Window IDs (WIDs) is increased from 32 to 64 and three new overlay WIDs are provided. Extended Overlays can only be enabled on DBZ boards running in a standard resolution.

▼ To Configure for Extended Overlay Mode

- Enter the following:

```
ffbconfig -extovl enable
```

Impact on Screen Visual List by Various `fbconfig` Visual Flags

Effect on the Default Visual and the Visual Group Ordering

In summary, the appearance of the X server screen visual list can be changed to fit the user's needs using any of the `fbconfig` visual flags (e.g., `linearorder`, `overlayorder`, `expvis`, `sov`, etc.). This section briefly shows the effect of these visual options on the visual list.

Without any alteration using `fbconfig`, the X server screen visual list can roughly be categorized in the following visual groups and order:

- 8-bit PseudoColor
- 8-bit Miscellaneous (StaticColor, Non-linear StaticGray, etc)
- 8-bit Linear StaticGray
- 8-bit PseudoColor Overlay
- 24-bit Non-linear TrueColor
- 24-bit DirectColor
- 24-bit Linear TrueColor

The default screen visual will be the 8-bit PseudoColor visual. The `deflinear` and `defoverlay` options will alter this pointer to point to the first 8- or 24-bit linear visual, depending on the X server depth when it starts up, and the first 8-bit overlay visual, respectively. You can rearrange the entire “8-bit PseudoColor Overlay” group, the “8-bit Linear StaticGray” group, and the “24-bit Linear TrueColor” group to be ahead of all other visual groups of the same depth by using the `linearorder` and `overlayorder` flags. For example, if you specify the following:

```
fbconfig -overlayorder first
```

The screen visuals list will be rearranged in the following order:

- 8-bit PseudoColor Overlay
- 8-bit PseudoColor
- 8-bit Miscellaneous (StaticColor, Non-linear StaticGray, etc.)
- 8-bit Linear StaticGray
- 24-bit Non-linear TrueColor

- 24-bit DirectColor
- 24-bit Linear TrueColor

Effect on the Number of Visual Instances Within Selected Groups

The `expvisflag` will change the number of visual instances in the following visual groups:

- 8-bit PseudoColor
- 8-bit PseudoColor Overlay
- 24-bit Non-linear TrueColor
- 24-bit DirectColor
- 24-bit Linear TrueColor

The number of instances that `expvis` will alter depends on whether the monitor is in monoscopic or stereoscopic resolution. In monoscopic resolution, if `expvis` is enabled, the order of the screen visual groups will be preserved, but within each group mentioned above, a “double-buffer capable” visual instance will be added. In stereoscopic resolution, two additional visual instances: “double-buffer, stereo capable” and “single-buffer, stereo capable”, will be added. The “double-buffer capable” visual instances, if present, will always come ahead of the “single-buffer capable” visual instances, and the monoscopic visual instances will always come ahead of the stereoscopic ones.

For example, if you specify the following in stereoscopic resolution:

```
ffbcfg -overlayorder first -expvis enable
```

the screen visual list will be:

- 8-bit PseudoColor Overlay (Mono, Stereo)
- 8-bit PseudoColor (DB Mono, SB Mono, DB Stereo, SB Stereo)
- 8-bit Miscellaneous (StaticColor, Non-linear StaticGray... etc)
- 8-bit Linear StaticGray
- 24-bit Linear TrueColor (DB Mono, SB Mono, DB Stereo, SB Stereo)
- 24-bit Non-linear TrueColor (DB Mono, SB Mono, DB Stereo, SB Stereo)
- 24-bit DirectColor (DB Mono, SB Mono, DB Stereo, SB Stereo)

Note – There is no double-buffer capable overlay visual instance.

Addition of the SERVER_OVERLAY_VISUALS Property and the Transparent SOV Visuals in the 8-bit Overlay Group

Without the `sov` option being enabled, the only overlay visuals available are the ones without transparency. Enabling the `sov` option will add the transparent SOV visual instances into the screen visual list and also add the `SERVER_OVERLAY_VISUALS` property to the root window property. The transparent SOV visual instances belong to the “8-bit PseudoColor Overlay” visual group. The `SERVER_OVERLAY_VISUALS` property will contain the visuals’ ID, transparent type, value, and layer of all available overlay visuals of the screen.

For example, if you specify the following in stereoscopic resolution:

```
fffbconfig -overlayorder first -expvis enable -sov enable
```

the screen visuals list will be:

- 8-bit PseudoColor Overlay (Mono, Stereo, Mono SOV, Stereo SOV)
- 8-bit PseudoColor (DB Mono, SB Mono, DB Stereo, SB Stereo)
- 8-bit Miscellaneous (StaticColor, Non-linear StaticGray, etc.)
- 8-bit Linear StaticGray
- 24-bit Linear TrueColor (DB Mono, SB Mono, DB Stereo, SB Stereo)
- 24-bit Non-linear TrueColor (DB Mono, SB Mono, DB Stereo, SB Stereo)
- 24-bit DirectColor (DB Mono, SB Mono, DB Stereo, SB Stereo)

and the `SERVER_OVERLAY_VISUALS` property will contain the following information:

```
=====
                SERVER OVERLAY VISUALS (SOV) Info
=====
No. of SOV visuals = 4
SOV #0, ID 0x36, TRANSPARENT_TYPE 0, VALUE 0, LAYER 1
SOV #1, ID 0x37, TRANSPARENT_TYPE 0, VALUE 0, LAYER 1
SOV #2, ID 0x38, TRANSPARENT_TYPE 1, VALUE 255, LAYER 1
SOV #3, ID 0x39, TRANSPARENT_TYPE 1, VALUE 255, LAYER 1
=====
```

Stereo Connector

The stereo connector allows connection of stereo goggles to the Creator Graphics Accelerator. Two versions of stereo connector are used on the Creator Graphics Accelerator: a female, three-conductor, mini-phone connector used on the Series 1 board and a seven-pin DIN connector used on the Series 2 board.

Creator Series 1 Stereo Connector

The stereo connector for the Creator Series 1 board is a female, three-conductor, mini-phone connector, as shown in FIGURE 2-1.

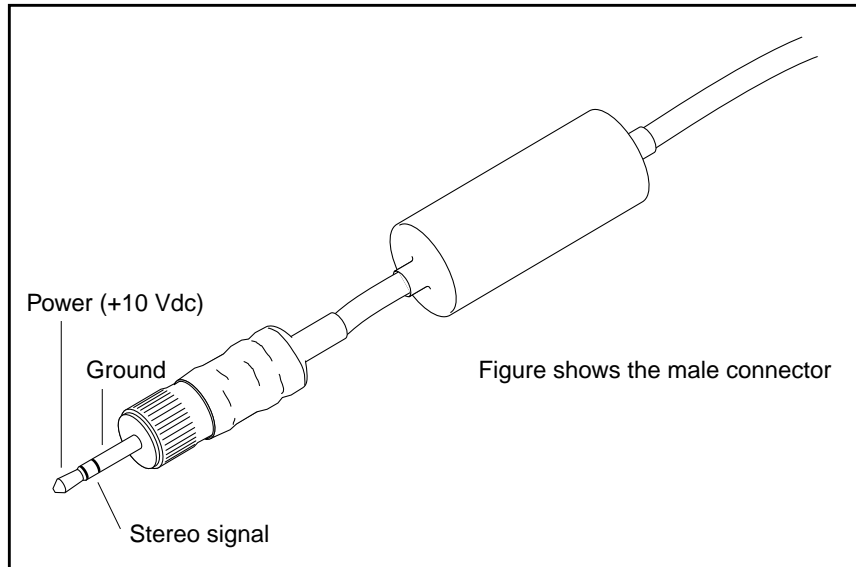

FIGURE 2-1 Creator Series 1 Stereo Connector

Creator Series 2 and Series 3 Stereo Connector

The stereo connector for the Creator Series 2 and Series 3 boards is a seven-pin DIN connector, as shown in FIGURE 2-2.

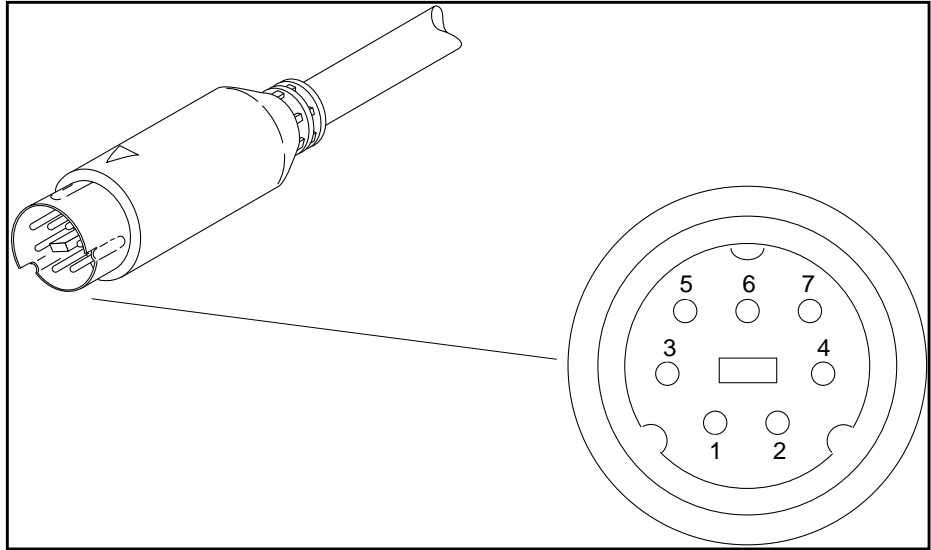

FIGURE 2-2 Creator Series 2 and Series 3 Stereo Connector

TABLE 2-5 lists the stereo cable signals.

TABLE 2-5 Creator Series 2 and Series 3 Stereo Connector Signals

Pin	Description
1	Ground
2	No connection
3	+12V
4	STEREO signal
5	No connection
6	No connection
7	No connection

Stereo Signal

The STEREO signal is a TTL-level, 50 percent duty cycle signal that switches between left and right stereo shutters, as shown in FIGURE 2-3.

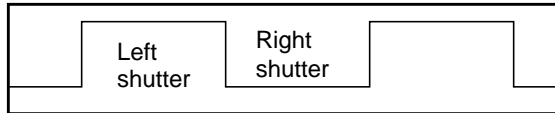

FIGURE 2-3 Creator Stereo Signal

A stereo cable and goggles for use with the Creator Graphics Accelerator are available from the following source:

StereoGraphics Corporation
2171-H East Francisco Blvd.
San Rafael, CA 94901
(415) 459-4500
FAX: 415-459-3020

The Creator Window System

This chapter describes how the Solaris™ X11 window system is used with the Creator and Creator 3D Graphics Accelerators.

The Creator accelerators are a high performance combination of the GX, SX, ZX, and S24 display adaptors. Like the ZX graphics accelerator, the Creator accelerator provides advanced frame buffer capabilities such as:

- Multiple plane groups
- Hardware double buffering
- Non-interfering transparent overlays
- 3D acceleration
- Stereoscopic support

Like the SX accelerator, the Creator accelerator is an X-channel architecture display adaptor. See Section “Creator Visuals” on page 3-40.

Like the GX accelerator, the Creator accelerator provides accelerated X11 rendering operations and hardware cursor support. See “Cursor Management” on page 48.

Like the S24 accelerator, the Creator accelerator provides both gamma corrected and uncorrected visuals. See “Creator Visuals” on page 40.

Like GX, SX, and ZX, the Creator accelerator supports multiple monitor video modes. See “Device Configuration” on page 49.

The Creator accelerator comes in two configurations: SB (Creator) and DBZ (Creator 3D). SB stands for “Single Buffer” and DBZ stands for “Double Buffer plus Z.” Z values are per-pixel depth information. These configurations differ in the amount of video memory on the board. The Creator 3D accelerator provides additional memory for hardware double buffering and 3D rendering.

Creator Visuals

The built-in factory default visual for the Creator accelerator is eight-bit PseudoColor. The user can specify a different default visual using the `defdepth` and `defclass` options of `Xsun(1)` and the `-defoverlay` and `-deflinear` options of `ffbconfig(1m)`.

Note – The Creator accelerator is also called the Fast Frame Buffer (FFB). The FFB name is used in Creator software package names, loadable device pipeline module names, the configuration program, and device man pages.

When starting OpenWindows, you can specify an alternate default visual using standard OpenWindows command line options. Any of the exported visuals can be selected as the default. For example, you can select the 24-bit TrueColor visual to be the default by using the `openwin defdepth 24` option (see `Xsun(1)`). A 24-bit default helps to reduce colormap flashing.

List of Visuals

The Creator accelerator exports eleven visuals on the X11 screen visual list. You can query these visuals using `XGetVisualInfo(3)` or `XMatchVisualInfo(3)`. The linearity of a visual can be queried using `XSolarisGetVisualGamma(3)`. The visuals are:

- 8-bit PseudoColor
- 8-bit StaticColor
- 8-bit GrayScale
- 8-bit StaticGray
- 8-bit TrueColor
- 8-bit DirectColor
- 8-bit StaticGray Linear
- 24-bit TrueColor
- 24-bit DirectColor
- 24-bit TrueColor Linear
- 8-bit PseudoColor Overlay

Note – In the above list, a visual is non-linear (not gamma corrected) unless it is explicitly specified to be linear. Also, an 8-bit visual resides in the Creator accelerator underlay plane group unless it is explicitly specified to reside in the overlay. 24-bit visuals are always underlay.

FIGURE 3-1 shows how the Creator accelerator visuals relate to the pixel storage (plane groups) in the frame buffer. X, B, G, and R denote the four 8-bit channels in which pixel data can be stored. The figure shows pixel storage for Creator Series 1, 2, and 3 with extended overlay option disabled.

The B, G, and R channels can either store 8-bit pixel data (in the red channel only) or 24-bit pixel data (using all three channels). The R channel provides storage for windows of seven different visual types (the 8R visuals). The BGR channels provide storage for windows for three different visual types (the 24-bit visuals). Only one visual is provided by the X channel: 8X PseudoColor.

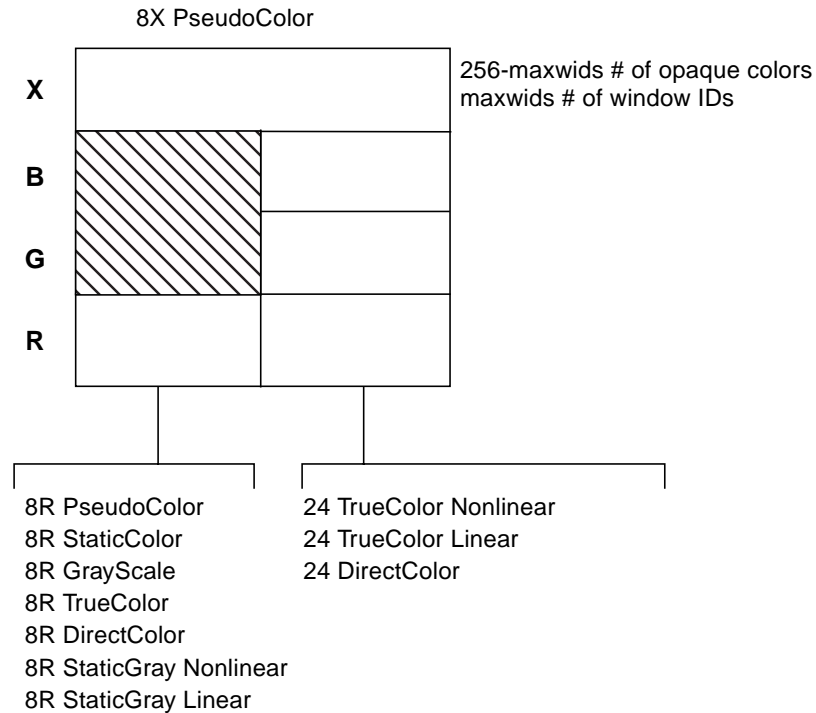

FIGURE 3-1 The 11 Creator Accelerator Visuals

The `colormap_size` of the underlay visuals is 256. In the Creator Series 1 and 2, the `colormap_size` of the overlay visual is `256 - maxwids`. The Creator Series 3 can be configured to use a full 256-color overlay or to run in Series 1 or 2 compatibility mode with `25 - maxwids` colors.

Overlay and Underlay Structure

The underlay 8-bit PseudoColor visual is sometimes referred to as the 8R visual because the pixel is stored in the red channel of the frame buffer. The overlay 8-bit PseudoColor visual is referred to as the 8X visual because it is stored in the X channel.

The window pixels in the overlay visual do not interfere with the window pixels in the underlay visuals. However, window pixels in the underlay visuals do interfere with window pixels in the overlay visual. This is true because underlay windows have color data which lives in the BGR (or just R) channels but they also have window id (WID) data which resides in the X channel. This can cause an x11 expose event (damage) to be generated.

When an overlay window is occluded by an underlay window, the WID portion of the underlay data will corrupt the color data of the overlay window. When the underlay window is moved away again, an x11 expose event will be sent out for the damaged portion of the overlay window. This is different from the ZX accelerator, which has mutually non-interfering underlays and overlays. Like the ZX accelerator, the pixels of Creator 8-bit underlay windows interfere with the pixels of 24-bit underlay windows.

The Creator accelerator follows an *X-channel architecture*. In this architecture, some pixel values in the 8X plane group display opaque colors and some codes are used as window IDs that control the display of pixels in the underlay visuals.

The Creator 3D Series 3 has an extended overlay mode that has non-interfering overlays and underlays like the ZX accelerator. When this mode is enabled, the window id plane group no longer shares the X or overlay channel so that an underlay window will not cause an x11 expose (damage) event.

The `maxwids` configuration option to `ffbconfig(1m)` specifies how many of the overlay pixel values are to be used as hardware window IDs. See “Hardware Window IDs” on page 47” for details. The minimum legal value for `maxwids` is 1. The default value is 32. Thus, the overlay visual is a *partial* visual because it has less than the usual 256 colormap entries. For colormaps of this visual, if the client renders with a pixel value greater than or equal to the specified number of colormap entries, no error is generated and the colors displayed are undefined.

Comparison with the SX Accelerator

The visual architecture of the Creator accelerator is most similar to the CG14, the display adaptor of the SX accelerator. CG14 is also an X-channel architecture display adaptor that has 8-bit and 24-bit underlay visuals and a single 8-bit PseudoColor overlay visual. However, there are two primary differences, as described in the sections that follow.

Gamma Correction

The Creator accelerator has some visuals that are gamma-corrected and some that are not. A gamma-corrected visual is called a *linear* visual. The linear visuals are:

- 24-bit TrueColor Linear
- 8-bit StaticGray Linear

Both linear and non-linear visuals are present on the X11 screen visual list, which can be queried with `XGetVisualInfo`. Because linearity is not a visual property recognized by the X11 core protocol, an extended routine must be called to distinguish a linear visual from its nonlinear counterpart. This routine is `XSolarisGetVisualGamma`. Refer to the `XSolarisGetVisualGamma(1)` man page for further details.

CG14 does not have linear visuals like the Creator accelerator. It performs gamma correction using a special Gamma LUT that affects the entire screen. Thus, it is not possible on the CG14 to have both gamma-corrected and uncorrected 24-bit windows on the screen at the same time. This is possible, however, on the Creator accelerator.

Single Color LUT

CG14 has two hardware color LUTs. One is used by the 8-bit underlay visuals and the other is used by the 8-bit overlay visual. In contrast, the Creator accelerator Series 1 and 2 have only one hardware color LUT. This means that an overlay window on the Creator accelerator will colormap flash against an 8-bit underlay window unless precautions are taken to make sure that the colormaps of the two windows use the same colors in the same pixel locations. Creator series 3 has four hardware color LUTs whose allocation and sharing is managed by the Xserver.

When programming for the case where there is only one color LUT on a Creator accelerator, take precautions to share overlay and underlay colors on transparent overlay applications. Since the overlay visual is always a different visual from the underlay visual, a transparent overlay application always requires at least two separate colormaps: one for the overlay and one for the underlay. The overlay window is usually a child of the underlay window and the pixels are correlated (i.e.,

spatially congruent) by the application. In this situation, when the mouse pointer is inside the boundary of the underlay and overlay window pair, the overlay colormap will be installed in the hardware CLUT and the underlay colormap will not be installed. Thus, take care to ensure that underlay pixels display the correct colors when viewed through the overlay colormap. This can be done by allocating colors in the same position in both the underlay and overlay colormaps.

Comparing Creator with the ZX Accelerator

Unlike the ZX accelerator, the built-in factory default visual on the Creator accelerator is not an overlay. On the ZX accelerator, the default visual is the overlay 8-bit PseudoColor visual. But on the Creator accelerator, like the SX accelerator, it is the 8-bit *underlay* PseudoColor visual. Thus, if you want to create applications with pop-up windows that are non-damaging with underlay windows, you cannot simply use the default visual. Instead, applications should call `XSolarisOvlSelectBestOverlay` to find a non-damaging overlay visual. Refer to the Solaris documentation on the OVL extension to X.

Note – `XSolarisOvlSelectBestOverlay` was first introduced in Solaris 2.4. If an application needs to run on Solaris 2.3 or earlier as well as on Solaris 2.4, define the external reference to this function as `#pragma weak`. The program can then check the value of this symbol. If this symbol has the value of 0, then the program is running on Solaris 2.3 or earlier. In this case, `XSolarisOvlSelectBestOverlay` cannot be called to find the overlay visual. Instead, the application can use `XGetVisualInfo` to find the first 8-bit visual with less than 256 colormap entries. However, this technique is specific to the Creator accelerator and is not portable to other devices.

Window Manager Implications

Because the Creator accelerator default visual is not an overlay, problems occur when overlay windows are not override-redirect (i.e., wrapped with a window manager decoration window). The Solaris-supported window managers `olwm`, `mwm`, and `dtwm` always wrap toolkit subwindows with decoration windows in the default visual. This occurs even if an application specifies a non-default visual for the pop-up window.

For example, when the default visual is 8-bit underlay PseudoColor, the window manager will wrap it with an 8-bit *underlay* decoration window even if an application specifies to a toolkit that a pop-up window is to be placed in the 8-bit *overlay* PseudoColor visual. Thus, the pop-up continues to damage other underlay windows, which is not the intended effect.

Use the following workarounds to this limitation:

- Require that the end user configure the default visual as the overlay visual by typing the following before starting the window system:

```
/usr/sbin/ffbconfig -defoverlay true
```

Keep in mind that the overlay visual has less colormap entries than the underlay 8-bit visual. Thus, the default colormap may fill up sooner, which may lead to increased colormap flashing.

- Rewrite the application to create override redirect pop-ups and manage them directly through Xlib, bypassing the toolkit.

Hardware Color LUT Usage

The following visuals use a color LUT:

- 8-bit PseudoColor
- 8-bit StaticColor
- 8-bit GrayScale
- 8-bit TrueColor
- 8-bit DirectColor
- 24-bit DirectColor
- 8-bit PseudoColor Overlay

On the Creator accelerators where there is only one color LUT, the colormaps of these visuals colormap flash against each other. Refer to “Reducing Colormap Flashing” on page 45” for how to avoid colormap flashing.

The other Creator accelerator visuals don’t use color LUT resources. Colormaps of these visuals never flash.

Reducing Colormap Flashing

The 24-bit TrueColor visual of the Creator accelerator can display over 16 million colors simultaneously without colormap flashing. Furthermore, the Creator rendering engine is optimized for 24-bit rendering. Consequently, it is very desirable for users and X client programmers to use this visual.

Notes to End Users

Even though 24-bit TrueColor offers fast rendering and no colormap flashing, the built-in factory default visual on the Creator accelerator is 8-bit PseudoColor. This was done to accommodate X applications that don't handle a 24-bit visual properly. It is better to have programs run and colormap flash than to not run at all. Fortunately, the majority of desktop applications do run properly with this visual.

Users who desire less colormap flashing on their desktop can run the window system with the default visual configured to 24-bit TrueColor. This is the recommended mode of running the window system on the Creator accelerator.

- **To run OpenWindows in this mode, use the following command:**

```
openwin -dev /dev/fbs/ffb0 defdepth 24
```

- **To run CDE in this mode, edit the `/usr/dt/config/Xservers` file and add "defdepth 24" to the appropriate X start-up command for your server.**

Be aware of the following conditions when using this mode:

- Some X applications cannot handle the 24-bit default. These type of programs usually fail to run and issue a BadMatch error message. Other programs may core dump or draw incorrect colors. If you encounter such an application, you can diagnose the problem by rerunning the application under the 8-bit PseudoColor default visual. If the program works, it probably cannot handle a 24-bit TrueColor default visual. Contact the application supplier and request an upgraded program. In the meantime, use the factory default 8-bit PseudoColor visual mode until the application is fixed.
- When the default visual depth is 24-bit, pixmaps and window backing store will occupy four times the space as in an 8-bit depth. This usually does not increase the working set of the server, but it does increase swap space. If you run programs that use lots of pixmaps or backing store windows, stay in 8-bit mode.

Notes to Programmers

X client programmers should strive to write programs that are *24-bit clean*, so that they run properly when the default visual is 24-bit TrueColor.

A program might fail to be 24-bit clean for several reasons. Following are some programming practices to avoid:

- Do not assume that the default visual is 8-bit PseudoColor.

Some programs only run in 8-bit depth because they have been ported from 8-bit-only systems and they have not been upgraded. Some programs might store their lists of pixels in a 256-element array. Other programs may require a modifiable colormap to perform colormap double buffering.

If your program requires 8-bit PseudoColor, check the depth and class of the default visual. If it's not the 8-bit PseudoColor visual, search the visual list until you find it.

- Do not inherit the border pixel from the parent.

On a multiple plane group device like the Creator accelerator, the depth of the window you are creating may not match the depth of the parent window (which is often the root window). Unless you specify an explicit border pixel value, the border pixel value of the window is inherited from the parent. If the depths differ, `XCreateWindow` will fail with a `BadMatch` error. Always use `XCreateWindow` rather than `XCreateSimpleWindow` and explicitly specify a border pixel value.

Test your applications under both “`defdepth 8`” and “`defdepth 24`” modes of the window system.

Hardware Window IDs

Each window requires a hardware Window ID (WID) to display the contents of its pixels.

Note – Do not confuse the term *Window ID* used in this context with the X protocol term *window ID*. An X protocol window ID is an `XID` which uniquely identifies a window. A hardware window ID is a value rendered into the frame buffer that controls window appearance.

Some overlay pixel codes are treated as opaque pixels, which display visible colors. Other overlay pixel codes are used to control the display attributes of underlay windows. These codes are referred to as *hardware window IDs* (WIDs). Specifically, a certain number of codes at the high end of the colormap (toward 255) are used as WIDs. The actual number of WIDs is configurable through the `ffbconfig - maxwids` option. For each overlay code used as a WID, the number of overlay colormap entries is reduced by one. The default value of `maxwids` is 32, so there are 224 opaque pixel values in the overlay.

One hardware WID is always reserved for windows of the default visual. The remaining WIDs are assigned on a priority basis to windows that have the following characteristics:

- Non-default visual

- Double buffered
- Assigned a unique WID for the purposes of hardware WID clipping. (This clipping technique is used by the Sun 3D rendering libraries).

Non-default visual windows can share a WID with other windows of the same visual. However, like unique WID windows, double buffered windows always require a unique dedicated WID.

Creating these types of windows reduces the number of other types of windows that can be created. If all available WIDs are assigned, the call to `XCreateWindow` will return a `BadAlloc` failure.

`maxwids` must be a power-of-two. Thus, legal values for `maxwids` are: 1, 2, 4, 8, 16, and 32. The default value of `maxwids` is 32.

Reducing `maxwids` increases the number of opaque color pixels in the overlay visual but reduces the number of XGL, double buffered, and non-default visual windows that the user can create.

Cursor Management

The Creator accelerator has a hardware cursor. The image of this cursor is directly mixed into the output video signal. A software cursor, on the other hand, must be rendered into the frame buffer and the contents of the previous frame buffer must be temporarily stored. A software cursor incurs more overhead than a hardware cursor. A hardware cursor provides optimal interactive response when moving the cursor.

The maximum size of the Creator hardware cursor is 64 x 64. Cursors with an image whose width or height is less than or equal to 64 use the hardware cursor. Otherwise, they are rendered as software cursors.

The software cursor on the Creator accelerator is rendered in the overlay plane group. Therefore, software cursors interfere with pixels of overlay windows but not with pixels of underlay windows.

An X11 cursor has a foreground and background color that the client application requests. The colors of hardware cursors are rendered exactly as they are requested. However, the colors of software cursors may be approximations of the requested colors.

Note – A bug in existing Solaris Visual graphics libraries means that software cursors are not properly removed. To work around this bug, the cursor will, in the presence of any DGA-grabbed window, be forced to be a hardware cursor, even if this entails truncating the cursor image.

Hardware Double Buffering

Hardware double buffering is supported through MBX and XGL. MBX and XGL double buffering cannot both be used on a window at the same time.

Hardware double buffering is provided for 8R windows on all the Creator accelerator configurations. Hardware double buffering for 24-bit windows is only provided on the Creator/DBZ (Creator3D) configuration. 8X overlay windows are never hardware double buffered on any Creator accelerator configuration; 8X windows are always software double buffered.

Activating hardware double buffering through MBX consumes one WID. This reduces the number of other WID-consuming windows that can be created. See “Hardware Window IDs” on page 47.” If no WID is available, MBX falls back to software buffering mode in which a copy from a back buffer pixmap to the window is used to flip the buffers.

In MBX, the buffer flips occur synchronously. That is, the server request does not return until the vertical retrace period of the monitor occurs and the buffer is flipped. X11 clients may continue to run and send requests to the server, but will not be processed until pending buffer flips are complete.

Device Configuration

Use the `/usr/sbin/ffbconfig` program to alter the Creator accelerator’s monitor video mode, default visual, default linear order, and the number of WIDs. Refer to the `ffbconfig(1m)` man page for details.

Attempts to grab stereo through DGA are rejected unless the monitor is configured in a stereo video mode.

When the “shared” `OWconfig` file is being updated via `ffbconfig`, an error occurs if the `/usr/openwin` directory is remotely mounted. This occurs even though `ffbconfig` is a `setuid` root program. This is because in UNIX, the root user of the local machine is different from the root users on a remote machine. The workaround is to log in to the remote machine to execute `ffbconfig`.

Performance Notes

The following sections contain performance notes for the Creator Accelerator on various applications.

Direct Xlib

Direct Xlib is not supported on the Creator accelerator. The X shared memory transport feature (new in Solaris 2.5) should be used instead. To enable shared memory transport, set the following environment variables in the client environment:

```
setenv DISPLAY :0
setenv XSUNTRANSPORT shmem
setenv XSUNSMESIZE 512
```

Note – The last line specifies a client request buffer size of 512 kilobytes. Different request buffer sizes can be specified. However, 512 is a good compromise between the transport speed and the system memory resources consumed.

Applications that rely on `XPutImage` and Direct Xlib for fast pixel transfer into the frame buffer should instead use the MITSHM extension function `XShmPutImage` on the Creator accelerator. This function provides the fastest transfer of pixels into the frame buffer when the client is on the same machine as the X server.

If you are using `XShmPutImage` to a 24-bit visual, you may need to increase the amount of allocated shared memory beyond the default amount. See “The X11perf Benchmark” on page 51” for details.

The X11perf Benchmark

If you are running the x11perf benchmark when the default server visual is 24-bit TrueColor, the `-shmput<nn>` tests will fail. This is because this test requires more shared memory than that provided by the default `shmsys` configuration. The X11R5 version of x11perf version will core dump, while the X11R6 version will report an error and make no measurement.

To run this test, you will need to increase the amount of shared memory.

- **To increase the amount of shared memory, add the following line to `/etc/system`:**

```
set shmsys:shminfo_shmmax=8192000
```

No Creator Pixel Copy Hardware

The Creator accelerator does not have hardware for copying pixels within the frame buffer. Pixels are copied by reading the pixels into CPU registers and then writing them back to the frame buffer. Thus, pixel copies within the frame buffer are CPU-intensive. When the system is under heavy load, the performance of window dragging operations may suffer. For example, the ShowMe Whiteboard “Snap Region” image drag operation may slow down while an active SunVideo stream is being rendered. This effect does not occur on a TurboGX accelerator, which has pixel copy hardware.

Background None Window Transient Color Effects

Dragging the imagetool image palette window with mouse shift-left over the main imagetool window can leave areas of the main window temporarily cyan-colored. These areas are quickly repaired, but persist long enough to be noticed. The effect is particularly pronounced when the window being dragged is partially inside and partially outside the imagetool main window. These effects occur because the imagetool main window is an Xview `WIN_TRANSPARENT` window. This means the background of the corresponding X window is set to None. For this type of window, the server relies on the application to repair damaged areas after an occluding window is moved. This method of damage repair is inherently slow because the client must process damage events and send rendering requests.

The imagetool image palette window is an 8-bit window. The pixel data resides in the Creator accelerator 8-bit red channel. The background pixel value of this 8-bit window is a small number, typically 0x02. The data in the red channel doesn't damage data in the green and blue channels. The background of the main window was white (0xffffffff) but when the 8-bit window occludes, the pixel values are 0xffff02.

When the 8-bit window occludes the area, it is viewed as an 8-bit window. But when the 8-bit window is moved, the server immediately changes the window ID values in this region, indicating that the region is now to be viewed as a 24-bit window. This happens before the background is repaired. So, for a moment, the old pixel values in this region (0xffff02) are viewed as a 24-bit pixel. This pixel value is viewed as pure blue + pure green, which forms cyan.

Note – This effect can also be seen on the SX frame buffer, although the SX frame buffer stores its 8-bit windows in the blue channel, so the transient color is green + red, which appears as yellow.

This effect is not as noticeable on the SX frame buffer, because it is more difficult to detect a contrast difference between yellow and white. On the Creator accelerator however, the difference between cyan and white is more pronounced. The effect also takes longer to go away when the dragged window is partially outside the imagetool window. This occurs because the Creator hardware has more rendering state to maintain than the SX frame buffer; dragging outside the imagetool window causes the window manager to continuously update the imagetool window header. This causes text rendering operations to be interleaved with copy operations. And since both operations use different rendering state, the state must be continually loaded and reloaded into the Creator hardware context. Thus, the repair of the transient color regions in on Creator in this situation is slower than the SX.

This example has dealt specifically with imagetool, but this will happen with any X window whose background is set to None. A bug for this has been filed for imagetool (Bug id 1215303).

To summarize, transient color effects like the one described above will occur on any window that has Background set to None. Applications that use this type of window should use some another background mode to avoid these effects. The X server can then repair the damage soon after it occurs.

XIL Acceleration on the Creator Graphics Accelerator

This chapter describes the XIL functions that are specific to the Creator and Creator3D Graphics Accelerators.

XIL is Sun's foundation imaging and video library. Several important XIL functions have been accelerated for the Ultra platforms using the UltraSPARC Visual Instruction Set (VIS) and the Creator Graphics Accelerator.

XIL Data Types

XIL supports a very general image structure, but not all types of XIL images are accelerated using VIS and Creator. The XIL data types supported in the VIS port are:

- 1-, 2-, 3-, and 4-banded unsigned byte images
- 1-, 2-, 3-, and 4-banded signed short images
- Band-aligned child images
- All regions of interest
- XIL_PIXEL_SEQUENTIAL type images

Accelerated Functions

The following shows the XIL functions accelerated using VIS. Note that display molecules are defined for one- and three-banded XIL_BYTE images.

TABLE 4-1 Accelerated XIL Functions

Function	VIS Acceleration		Molecules		Comments
	8-bit	16-bit	Display	Other	
xil_absolute		1 - 4 bands			
xil_add	1 - 4 bands	1 - 4 bands	x		
xil_add_constant	1 - 4 bands	1 - 4 bands	x		
xil_affine	1 - 4 bands	1 - 4 bands	x		See Note 6
xil_and	1 - 4 bands	1 - 4 bands	x		
xil_and_constant	1 - 4 bands	1 - 4 bands	x		
xil_band_combine	1 - 4 bands	1 - 4 bands			
xil_blend	1 - 4 bands	1 - 4 bands			
xil_cast			x		
8 x 16	1 - 4 bands	1 - 4 bands			
16 x 8	1 - 4 bands	1 - 4 bands			
xil_convolve	1 - 4 bands	1 - 4 bands	x		See Note 1
xil_copy	1 - 4 bands	1 - 4 bands	x		
xil_decompress					See Notes 2, 5
xil_get_pixel					See Note 4
xil_lookup	1 - 4 bands	1 - 4 bands	x	x	See Note 5
xil_max	1 - 4 bands	1 - 4 bands	x		
xil_min	1 - 4 bands	1 - 4 bands	x		
xil_multiply	1 - 4 bands	1 - 4 bands	x		
xil_multiply_constant	1 - 4 bands	1 - 4 bands	x		
xil_not	1 - 4 bands	1 - 4 bands	x		
xil_or	1 - 4 bands	1 - 4 bands	x		
xil_or_constant	1 - 4 bands	1 - 4 bands	x		
xil_rescale	1 - 4 bands	1 - 4 bands	x	x	See Notes 3, 5

TABLE 4-1 Accelerated XIL Functions (Continued)

Function	VIS Acceleration		Molecules		Comments
	8-bit	16-bit	Display	Other	
<code>xil_rotate</code>	1 - 4 bands	1 - 4 bands	x		See Note 6
<code>xil_scale</code>	1 - 4 bands	1 - 4 bands	x	x	See Note 5, 6
<code>xil_set_pixel</code>			x		See Note 4
<code>xil_set_value</code>	1 - 4 bands	1 - 4 bands	x		
<code>xil_subtract</code>	1 - 4 bands	1 - 4 bands	x		
<code>xil_subtract_const</code>	1 - 4 bands	1 - 4 bands	x		
<code>xil_subtract_from_const</code>	1 - 4 bands	1 - 4 bands	x		
<code>xil_tablewarp</code>			x		See Note 4
<code>xil_threshold</code>	1 - 4 bands	1 - 4 bands	x	x	See Notes 3, 5
<code>xil_transpose</code>	1 - 4 bands	1 - 4 bands	x		
<code>xil_xor</code>	1 - 4 bands	1 - 4 bands	x		
<code>xil_xor_const</code>	1 - 4 bands	1 - 4 bands	x		

Notes to Table 7-1

Note 1: `xil_convolve` is accelerated for 3 x 3, 5 x 5, and 7 x 7 kernels.

Note 2: `xil_decompress` is accelerated for the following cases:

- `xil_decompress` + `color_convert` (JPEG compressed image or sequence and MPEG1 compressed sequence)
- `xil_decompress` + `color_convert` + `display` (JPEG compressed image or sequence and MPEG1 compressed sequence)
- `xil_decompress` + `color_convert` + `scale` + `display` (MPEG1 compressed sequence)

This decoder adheres to full-precision 24-bit CCIR 601 YCC to RGB709 color space conversion.

There are a few instances when decompression of streams will not be accelerated.

- Decompression of JPEG or MPEG1 streams which are not in one contiguous buffer in memory is not accelerated. For example, streams split up using `xil_cis_put_bits_ptr` might not be accelerated.
- If one frame in a stream is not accelerated for some reason (e.g. the decompressor encountered invalid data in the frame), subsequent frames in the stream will not be accelerated.

- Acceleration is also disabled if one tries to seek backwards or forwards in a stream.

Note 3: `xil_rescale + xil_threshold + xil_threshold + display molecule` is accelerated using the Creator depth-cueing hardware. However, some restrictions apply, as follows:

- The first threshold must have a high value of 255. The low and map values must be equal (any number N between 0 and 255.)
- The second threshold must have a low value of 0. The high and map values must be equal (any number M between 0 and N).
- The parameters for `xil_rescale` must be chosen such that y values of the line represented must span the range of values between N and M while the x values are within 0 and 255. See FIGURE 4-1.
- The images must be 1-banded `XIL_BYTE` images.

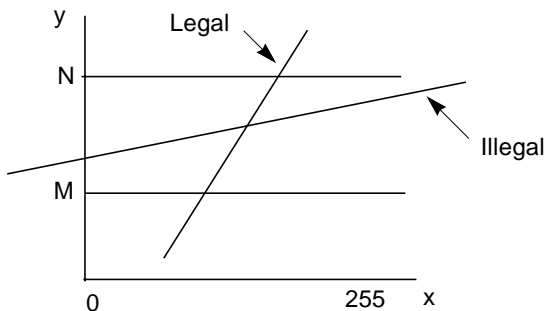

FIGURE 4-1 Creator Depth-cueing

The following code is an example of a correct call to invoke this molecule:

```
float scale[1] = 1.5;
float offset[1] = -10;
float t1_lo[1] = 255;
float t1_hi[1] = 240;
float t1_map[1] = 240;
float t2_lo[1] = 0;
float t2_hi[1] = 15;
float t2_map[1] = 15;
xil_rescale(src,tmp1,scale,offset);
xil_threshold(tmp1,tmp2,t1_lo,t1_hi,t1_map);
xil_threshold(tmp2,tmp3,t2_lo,t2_hi,t2_map);
xil_display(tmp3,display);
```

However, if the same calling sequence is done with `scale[1] = .40`, the molecule will not be invoked because the line `y = 0.40*x -10` only spans the range $y = -10$ to $y = (255*0.40) - 10 = 92$ between $x = 0$ and $x = 255$. For the molecule to execute, `y` must span at least the range $y = 15$ to $y = 240$ for x between 0 and 255.

Note 4: `xil_get_pixel`, `xil_set_pixel`, and `xil_tablewarp` are accelerated only as display molecules. For `xil_tablewarp`, only `interpolation = "nearest"` is accelerated.

Note 5: All the molecules (other than a single `xil` function + display) that are accelerated are as follows:

- `xil_decompress + xil_colorconvert [+ display] (for JPEG)`
- `xil_decompress + xil_colorconvert [+ display] (for MPEG1)`
- `xil_decompress + xil_colorconvert + xil_scale + display (for MPEG1)`
- `xil_threshold + xil_threshold [+ display]`
- `[xil_rescale] + [xil_threshold] + [xil_threshold] + [xil_cast] + display`
- `xil_scale + xil_lookup + display (the accelerated molecules are for 8- or 16-bit bilinear scale followed by 8-to-8 bit or 16-to-8 bit lookup)`

Note 6: There are some restrictions on the acceleration of `xil_affine`, `xil_scale`, and `xil_rotate`: `xil_affine` and `xil_rotate` are accelerated only for 1-, 3-, and 4-banded images with "nearest" interpolation, and only for 1- and 3-banded images with "bilinear" and "bicubic" interpolation. The restriction for `xil_scale` is that in the case of `interpolation = "general"` the size of the resampling kernels are limited to 8 x 8 for 8-bit images, and 8 x 4 for 16-bit images.

Double Buffer Support

XIL supports double buffers on hardware where double buffers are available (e.g. the Creator family). This section describes the double buffer support functions and their usage.

The functions are:

- `xil_create_double_buffered_window`
- `xil_set_active_buffer`
- `xil_get_active_buffer`
- `xil_swap_buffers`

If you want to use a display image as a double-buffered display image, then instead of using `xil_create_from_window`, use `xil_create_double_buffered_window` to create the image. Trying to use `xil_create_double_buffered_window` on hardware that does not support double buffers returns a NULL device. The developer must catch the failure and call `xil_create_from_window` instead.

If the image was created with `xil_create_double_buffered_window` and the hardware supports double buffers, then `XilBufferId` makes sense and can take two values, `XIL_BACK_BUFFER` and `XIL_FRONT_BUFFER`. For such a window, one of the buffers is considered to be active at any time, and all functions writing to the image will be writing the active buffer (for example a copy to the image will copy the pixels to the active buffer of the image). On the other hand, the front buffer is the one that is visible, i.e. displayed on the screen. At creation time, the active buffer is `XIL_BACK_BUFFER`.

To start using the display image as a double buffered image after it has been created by `xil_create_double_buffered_window`, you need to take no special action since the active buffer is `XIL_BACK_BUFFER`. If the active buffer has been set to `XIL_FRONT_BUFFER`, the image will not be used as a double-buffered image (although imaging operations will not fail). To start using it again as a double-buffered image, make a call like the following:

```
xil_set_active_buffer(dest, XIL_BACK_BUFFER)
```

which will cause output to go to the back buffer. Note that in this case, the content of the image will not be displayed (i.e., visible) without some action from the user. The action to take is a call like the following:

```
xil_swap_buffers(dest)
```

This will make the content of the image visible. When the image is not needed as a double-buffered image any longer, make a call like the following:

```
xil_set_active_buffer(dest, XIL_FRONT_BUFFER)
```

This ensures that the write and display buffers of the hardware are reset to their default values.

The following is a typical code segment for using double buffers:

```
dest =
xil_create_double_buffered_window(state,display,dwindow);
...
for (i=0; i<repeat; i++) {
...
xil_lookup(src,dest,lut);
xil_swap_buffers(dest);
}
xil_set_active_buffer(dest,XIL_FRONT_BUFFER);
```

PGX Graphics Accelerator

This chapter describes how to change the display resolution on the PGX Graphics Accelerator.

You can change the PGX screen and associated graphics hardware through the `m64config` utility. Options are specified on the command line. The specified options can be stored in the `OWconfig` file to provide persistence of the options across window system sessions and system reboots.

Use the `m64config` utility to:

- Specify the video mode (screen resolution and refresh rate).
- Specify the `OWconfig` file to update.
- Reset all option values to their default values.
- Print the current values of all PGX options in the `OWconfig` file.
- Print the PGX hardware configuration.

Note – `m64` is the UNIX device name for the PGX Graphics Accelerator.

Supported Screen Resolutions

TABLE 5-1 lists the screen resolutions that are supported by the PGX Graphics Accelerator.

TABLE 5-1 PGX-supported Screen Resolutions

Screen Resolution	Vertical Refresh Rate	Description
1600 x 1000	76 Hz	Non-interlaced
1600 x 1000	66 Hz	Non-interlaced
1440 x 900	76 Hz	Non-interlaced
1280 x 1024	76 Hz	Non-interlaced
1280 x 1024	75 Hz	Non-interlaced
1280 x 1024	67 Hz	Non-interlaced
1280 x 1024	60 Hz	Non-interlaced
1280 x 800	76 Hz	Non-interlaced
1152 x 900	76 Hz	Non-interlaced
1152 x 900	66 Hz	Non-interlaced
1024 x 768	75 Hz	Non-interlaced
1024 x 768	70 Hz	Non-interlaced
1024 x 768	60 Hz	SVGA (non-interlaced)
800 x 600	75 Hz	Non-interlaced
768 x 575	50 Hz	PAL (interlaced)
640 x 480	60 Hz	NTSC (interlaced)

Changing the Screen Resolution Temporarily

This example changes the screen resolution temporarily. It can be used to verify that the monitor supports the specified resolution.

```
/usr/sbin/m64config -res video-mode try
```

TABLE 5-2 lists the *video-mode* options. You are given ten seconds to confirm the video mode by typing *y*.

TABLE 5-2 PGX-screen Resolution Formats

Video Mode		
WidthxHeightxRate	Symbolic Name	Resolution
1600x1000x76		1600 x 1000 at 76 Hz
1600x1000x66		1600 x 1000 at 66 Hz
1440x900x76		1440 x 900 at 76 Hz
1280x1024x76	1280	1280 x 1024 at 76 Hz
1280x1024x75		1280 x 1024 at 75 Hz
1280x1024x67		1280 x 1024 at 67 Hz
1280x1024x60		1280 x 1024 at 60 Hz
1280x800x76		1280 x 800 at 76 Hz
1152x900x76	1152	1152 x 900 at 76 Hz
1152x900x66		1152 x 900 at 66 Hz
1024x768x75		1024 x 768 at 75 Hz
1024x768x70		1024 x 768 at 70 Hz
1024x768x60	svga	1024 x 768 at 60 Hz
800x600x75		1024 x 600 at 75 Hz
768x575x50i	pal	768 x 575 at 50 Hz, interlaced
640x480x60i	ntsc	640 x 480 at 60 Hz, interlaced
	none	The video mode currently programmed for the device

For example, to try the 1152 x 900 resolution at 76 Hz, enter one of the following formats:

This example uses the WidthxHeightxRate format

```
/usr/sbin/m64config -res 1152x900x76 try
```

This example uses the symbolic name format.

```
/usr/sbin/m64config -res 1152 try
```

Printing the PGX Hardware Configuration

- **To print the PGX hardware configuration information, type:**

```
/usr/sbin/m64config -prconf
```

The following is a typical display of the hardware configuration information:

```
--- Hardware Configuration for /dev/fbs/m640 ---
ASIC: version 0x41004754
DAC: version 0x0
PROM: version 0x0
Card possible resolutions: 640x480x60, 800x600x75, 1024x768x60
    1024x768x70, 1024x768x75, 1280x1024x75, 1280x1024x76
    1280x1024x60, 1152x900x66, 1152x900x76, 1280x1024x67
    960x680x112S, 960x680x108S, 640x480x60i, 768x575x50i,
1280x800x76
    1440x900x76, 1600x1000x66, 1600x1000x76, vga, svga, 1152, 1280
Monitor possible resolutions: 720x400x70, 720x400x88, 640x480x60
    640x480x67, 640x480x72, 640x480x75, 800x600x56, 800x600x60
    800x600x72, 800x600x75, 832x624x75, 1024x768x87, 1024x768x60
    1152x900x76, 1280x1024x67, 960x680x112S, vga, svga, 1152, 1280
    stereo
Current resolution setting: 1280x1024x76
Current depth: 8
```

For More Information

The examples in this chapter are only two of the simpler uses of the `m64config` utility. For more information on `m64config`, see the `m64config` man page.

PEX Library Bug Workaround

Some 3D applications may experience problems when run on the PGX frame buffer. Problems may range from incorrect rendering to window system crashes.

The work-around for these problems is to set the environment variable `XGLNOPEX` before executing any 3D applications. For example:

```
setenv XGLNOPEX
```

You do not have to assign any particular value to this environment variable, just create it.

PGX32 Graphics Accelerator

This chapter describes how to change the display resolution on the PGX32 Graphics Accelerator.

You can use the `GFXconfig` menu-style interface utility any time to change screen resolutions. See the `GFXconfig` man page for a detailed description.

Note – `gfx` is the UNIX device name for the PGX32 Graphics Accelerator.

Interactive Configuration

- To use `GFXconfig` to configure your PGX32 card, type:

```
# GFXconfig -i
```

The PGX32 configuration window is displayed (FIGURE 6-1).

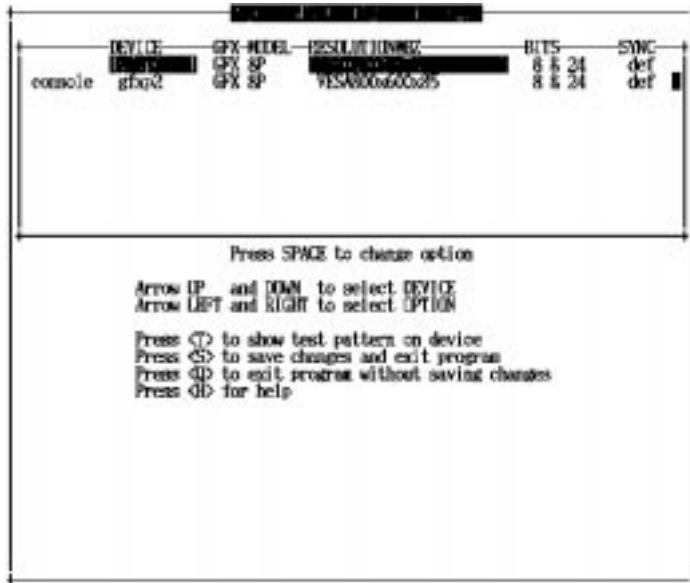

FIGURE 6-1 PGX32 Configuration Window

<Selemparanum describes the PGX32 configuration window.

TABLE 6-1 PGX32 Configuration Window

Function	Description
Up and down arrows	Selects the desired PGX32 device to modify.
Left and right arrows	Selects the parameter to modify (for example, screen resolution, bit-depth, or synchronization).
Space bar	Used to modify the parameter for the given PGX32 device (brings up a menu when applicable).
T	Puts a test pattern on the entire display. Press any key to return to the main screen.
S	Saves the current settings and exits the configuration window.
H	Help
Q	Exits the program without saving any changes.

Noninteractive Configuration

Sometimes it is convenient to configure the PGX32 card noninteractively. This method is especially useful when configuring many systems identically or when you know which configuration is appropriate for the system.

GFXconfig uses the same conventions as the m64config utility. m64config is used for all ATI-based graphics which includes the Sun Ultra 5 and Sun Ultra 10 motherboard graphics (both 8-bit and 24-bit systems) and PGX 8-bit PCI frame buffer. You can set all of the parameters that can be set using the interactive version by specifying the correct flag followed by a desired value. <Selemparanum describes these parameters.

TABLE 6-2 Noninteractive Configuration Parameters

Parameter	Description
-dev <i>device</i>	Displays the device to configure.
-res <i>resolution</i>	Displays the resolution name.
-res \?	Shows resolutions.
-file <i>filename</i>	Displays the configuration file: system or machine.
-depth <i>depth</i>	Shows the bit depth (8 or 24, default is 24).
-defaults	Resets the device to the default parameters.
-24only (true/false)	Forces all windows to use 24-bit visuals. This may prohibit some 8-bit applications from working.
-gfile <i>gamma file</i>	Lists the gamma file.
-gvalue <i>gamma value</i>	Lists the gamma value.
-propt	Displays the current settings.
-prconf	Displays hardware information.
-help	Shows usage information.

Note – By default, the bit depth is set to 8/24 for resolutions of 1280 x 1024 and less, or 8 only for higher resolutions.

Examples

- **To configure the resolution on the PGX32 to 1152 x 900 at 66, type:**

```
# GFXconfig -res 1152x900x66
```

To verify the resolution prior to setting it permanently, add the word “try” after the resolution name. This option displays a test pattern on the screen until you press the Return key. Then you can accept or reject the resolution. For example:

```
# GFXconfig -res 1152x900x66 try -dev /dev/fbs/gfxp0
```

- **To set the resolution to 1024 x 768 at 60 with a single TrueColor visual (no 8-bit PseudoColor visual), type:**

```
# GFXconfig -res 1024x768x60 -24only true
```

- **To see the current settings for /dev/fbs/gfxp0, type:**

```
# GFXconfig -propt -dev /dev/gfx/gfxp0
```

Other Methods for Changing the Screen Resolution

Normally, the default screen resolution is sufficient for most users. However, you may need to change the default resolution if:

- You change the X Windows depth from the default listed in the table, then you should configure the screen depth to match the X Windows depth.
- The monitor does not “sync up” at the default screen resolution, then you need to choose a different screen resolution.

Guidelines

The general guidelines to follow when changing the default screen resolutions are:

- To run the X Windows environment in 8/24 mode, set the screen resolution to 24 bit-depth.
- By default, screen resolutions 1280 x 1024 and lower will automatically be set to 24 bit. Higher resolutions will default to 8-bit mode.
- Use `GFXconfig -i` to test a resolution before configuring the screen to that resolution.

Methods

The procedures for changing the screen resolution described in this chapter include:

- EDID Auto-Detect feature
- Output device method
- Video-Mode method
- Video-Timing method

EDID Auto-detect Feature for PGX32

If you are using a monitor with DDC2B/EDID protocol, the default resolution will be determined using the Auto-Detect feature. With this protocol, the GFX card first checks the Standard Timing Identifiers (taking the first one supported), then tries to match the Established Timings. Failing the above method, the card will default to 1152 x 900 x 66.

Note – The monitor must be turned *on* prior to booting the system in order for the PGX32 to communicate with it.

The methods described in this appendix will override any information obtained via EDID.

output-device Method

It is possible to specify the screen resolution of PGX32 card via the `output-device` environment variable by using the format `screen:rAxBxC`, where: *A* is the desired horizontal resolution, *B* is the desired vertical resolution, and *C* is the desired refresh rate.

The system will check these values against an internal list of resolutions (see TABLE 6-3), and use the corresponding entry as the screen resolution.

For example, to use VESA1024 x 768 at 75 as the screen resolution, type the following at the `ok` prompt:

```
ok setenv output-device screen:r1024x768x75
ok reset
```

Note – The new screen resolution will take effect following the reset, and will hold the resolution information until the `output-device` variable is changed manually.

Video Mode Method

At the `ok` prompt in Boot PROM mode, the screen resolution can be easily set on the PGX32 cards by using one of the 34 preinstalled resolution modes. These resolution settings are identified by video modes 0-33 (TABLE 6-3).

Note – Use video modes 0-25 to select a screen depth of 24 bits, or video modes 26-33 to select a screen depth of 8 bits.

TABLE 6-3 PGX32 Screen Resolutions

Mode	Resolution
0	640 x 480 @ 60
1	640 x 480 @ 72
2	640 x 480 @ 75
3	640 x 480 @ 85
4	800 x 600 @ 60
5	800 x 600 @ 72
6	800 x 600 @ 75
7	800 x 600 @ 85
8	1024 x 768 @ 60
9	1024 x 768 @ 70
10	1024 x 768 @ 75
11	1024 x 768 @ 77 *
12	1024 x 768 @ 85

TABLE 6-3 PGX32 Screen Resolutions (*Continued*)

Mode	Resolution
13	1024 x 800 @ 85 *
14	1152 x 900 @ 60
15	1152 x 900 @ 66 *
16	1152 x 900 @ 70
17	1152 x 900 @ 75
18	1152 x 900 @ 76 *
19	1152 x 900 @ 85
20	1280 x 800 @ 76 *
21	1280 x 1024 @ 60
22	1280 x 1024 @ 67 *
23	1280 x 1024 @ 75
24	1280 x 1024 @ 76 *
25	1280 x 1024 @ 85
26	1600 x 1200 @ 66 *
27	1600 x 1200 @ 76 *
28	1600 x 1200 @ 60
29	1600 x 1200 @ 65
30	1600 x 1200 @ 70
31	1600 x 1200 @ 75
32	1600 x 1200 @ 76
33	1600 x 1200 @ 80 *

Note – See “Using `nvedit` to Modify NVRAM” on page 80 for a description of `nvedit` commands.

For example, to set the screen resolution to 1024 x 768 at 60Hz, video-mode 8, type:

```
ok nvedit
   0: 8 value video-mode  1: <ctrl-c>
ok nvstore
ok setenv use-nvramrc? true
ok reset
```

Note – The last three commands enable the NVRAM. Without these lines, the changes you make with `nvedit` will be ignored.

Video Timing Method

If all of the previously described methods fail for your configuration, it is possible to specify the exact timing numbers for a particular resolution. The last method for setting the screen resolution also uses `nvedit`. This method is more involved and requires knowledge of all timing parameters for the desired resolution. Therefore, this method is only meant for monitors whose resolutions are not available in the Video-Mode Method. See “Using `nvedit` to Modify NVRAM” on page 80 for a description of `nvedit` commands.

Note – You should use this method *only* if the previous methods have been unsuccessful.

For example, to set the screen resolution to 1280 x 1024 at 76 Hz:

```
ok nvedit
  0: : video-timing " 1280, 384, 32, 64, \
    1024, 43, 3, 8, 135000000, 0" ;
  1: <ctrl-c>
ok nvstore
ok setenv use-nvramrc? true
ok reset
```

Note – The syntax is very important. The spaces must be present exactly as they appear in the example.

Note – The last three commands enable the NVRAM. Without these lines, the changes you make with `nvedit` will be ignored.

Following is a brief description of the ten parameters used in this method.

- horizontal resolution (in pixels)
- horizontal blanking total
- horizontal front porch
- horizontal sync width

- vertical resolution (in lines)
- vertical blanking total
- vertical front porch
- vertical sync width
- dotclock in Hz
- sync value (see TABLE 6-4). Add the values together to select more than one.

TABLE 6-4 Sync Values

Sync Value	Meaning
1	separate sync
1	sync on green
512	positive vertical sync pulse
1024	positive horizontal sync pulse
2048	composite sync

Note – To obtain the timing parameters required to use this method, contact SunService at 1-800-USA-4SUN with your monitor requirements.

Setting PGX32 as the Console (Optional)

To use the PGX32 software as the console device, use the procedures in the sections that follow.

PGX32 Card as the Only Frame Buffer

Sun Ultra 5 and Sun Ultra 10 Systems

To use the PGX32 card as the system console in an Sun Ultra 5 or Sun Ultra 10 system as the only frame buffer, first disable the 8-bit or 24-bit onboard graphics, that comes standard with these systems.

- **To disable the 8-bit or 24-bit graphics device built into the motherboard, type:**

```
ok setenv pcib-probe-list 1,3
ok reset
```

Once the system is reset, all console messages are directed to the PGX32 card.

- **To restore the motherboard 8-bit or 24-bit graphics device as the console for any reason, simply add it back to `pcib-probe-list` by typing:**

```
ok setenv pcib-probe-list 1,2,3
ok reset
```

Sun Ultra 30 and Sun Ultra 60 Systems

If no other frame buffers are present in a Sun Ultra 30 or Sun Ultra 60, then the PGX32 card will be the console by default, provided that the board is in a valid probed PCI slot.

PGX32 Card With a Secondary Frame Buffer

The PGX32 card can be made the console device when other secondary frame buffers are present in the system.

Onboard Graphics (Ultra 5 and Ultra 10 Only)

The Sun Ultra 5 and Sun Ultra 10 standard onboard graphics and PGX32 card(s) can only coexist in the system if the onboard graphics device is the console. Otherwise, the onboard graphics device must be disabled as described above in “PGX32 Card as the Only Frame Buffer” on page 75.”

Systems With UPA Bus Frame Buffers

To configure the PGX32 card as the console when UPA frame buffers are in the system, the output-device variable in NVRAM must be changed to the actual path of the desired PGX32 cards. This path can best be determined by searching for the string `TSI` in the `/` tree at the `ok` prompt.

For example, to find the `pci` devices, type:

```
ok cd /pci@1f,4000
ok ls
```

When you are in the correct location, you should see at least one entry containing the string `TSI` (that is, `TSI,gfxp@#` where `#` is a digit representing your PGX32 slot location).

Use this entry as the console device for your desired PGX32 card. For example, if the path is `/pcid@1f,4000` (as shown above) to the device `TSI,gfxp@#`, type:

```
ok setenv output-device /pci@1f,4000/TSI,gfxp@#
ok reset
```

Note – Replace `#` with whatever your PGX32 device requires.

Once the system is reset, all console messages will be directed to that PGX32 card.

To restore the default graphics device as the console for any reason, simply set the `output-device` variable back to its default value of the screen. To do this, type:

```
ok setenv output-device screen
ok reset
```

Other PCI Frame Buffers

To make the PGX32 the console device when other PCI frame buffers are present in the system, it may be necessary to change the `pcia-probe-list` to probe the PGX32 slot before that of the secondary frame buffer (in addition to the changes described above in “PGX32 Card as the Only Frame Buffer” on page 75.)

- **Determine the slot numbers that correspond to these frame buffers, then ensure that the PGX32 slot number precedes that of the secondary frame buffer in the `pcia-probe-list`.**

For example, if the PGX32 is located in slot 3, and the secondary frame buffer is located in slot 1, then update the `pcia-probe-list` so that slot 3 is probed before slot 1. A possible configuration is:

```
ok setenv pcia-probe-list 3,2,1,4
ok reset
```

Once the system is reset, all console messages will be directed to the PGX32 card.

Starting the Desktop Environment

This section describes how to start the OpenWindows environment, Common Desktop Environment (CDE), and the X Display Manager on the PGX32 card.

OpenWindows Environment

The following sections describe how to start the OpenWindows environment as a console or with multiple PGX32 cards. The PGX32 device name is `gfxp#`.

Using the PGX32 Card as the Console

- If the PGX32 card is the console, type:

```
# openwin
```

Using Multiple PGX32 Cards

- To start the OpenWindows environment on two PGX32 devices, `gfxp0` and `gfxp1`, type:

```
# openwin -dev /dev/fbs/gfxp0 -dev /dev/fbs/gfxp1
```

Note – In the above example, the `gfxp` device numbers are 0 and 1. These may be different in your configuration. Please check `/dev/fbs/` or `dmesg` for correct device numbers.

Common Desktop Environment (CDE)

If you have installed CDE and would like CDE to appear on the PGX32 display, you need to modify your `/etc/dt/config/Xservers` file. If the SunForum card is the console device, you do not need to modify the `Xservers` file.

The following sample `Xservers.gfx` file assumes that the SunForum card is the only frame buffer on which to start CDE:

```
:0 Local Local_uid@console root /usr/openwin/bin/Xsun \  
:0 -dev /dev/fbs/gfxp0 -nobanner
```

Note – If for some reason the name of your SunForum device is something other than `gfxp0`, you need to substitute the correct name in the file.

You can add any other desired command line arguments to the end of this line. For example, you can start CDE on multiple displays.

- **To do this, list each display device following the convention above.**

The following example configuration displays CDE on the display named `/dev/fbs/gfxp0` and uses the device named `/dev/fbs/m640` (the built-in graphics device on the Sun Ultra 5 and Sun Ultra 10 systems) as a secondary frame buffer.

```
:0 Local Local_uid@console root /usr/openwin/bin/Xsun \  
:0 -dev /dev/fbs/gfxp0 -dev /dev/fbs/m640
```

X Display Manager

The SunForum card also supports the X display manager (`xdm`). A simple configuration file is provided as `/usr/openwin/lib/X11/xdm/Xservers`.

If you had an `Xservers` file already in place, the SunForum software installation will have saved it as `/usr/openwin/lib/X11/xdm/Xservers.nogfx`.

By default, the installation will have added the following line, which assumes that the SunForum is the only frame buffer on which to start `xdm`:

```
:0 Local Local /usr/openwin/lib/xdm/StartOW \  
:0 -dev /dev/fbs/gfxp0
```

You can add any other desired command line arguments to the end of this line. For example, you can start `xdm` on multiple displays.

- **To do this, list each display device following the convention above.**

The following example configuration displays `xdm` on the display named `/dev/fbs/gfxp0` and uses the device named `/dev/fbs/m640` (the built-in graphics device on the Sun Ultra 5 and Sun Ultra 10 systems) as a secondary frame buffer:

```
:0 Local Local_uid@console root /usr/openwin/bin/Xsun \  
:0 -dev /dev/fbs/gfxp0 -dev /dev/fbs/m640
```

Using `nvedit` to Modify NVRAM

- **To edit the NVRAM, begin the `nvedit` editor at the `ok` prompt:**

```
ok nvedit
```

See “Video Timing Method” on page 74 for using the `nvedit` editor. There are several key sequences that you must use to edit the variables in NVRAM:

TABLE 6-5 NVRAM Editor

Key Sequence	Description
Backspace	Delete the character preceding the cursor
ctrl-l	List NVRAM current values
ctrl-p	Move to the previous line
ctrl-n	Move to the next line
ctrl-b	Move to the previous character
ctrl-l	Delete to the beginning of the line

TABLE 6-5 NVRAM Editor

Key Sequence	Description
ctrl-k	Join the current and next line
ctrl-u	Delete the current line
ctrl-c	Exit <code>nvr</code> editor (return to <code>ok</code> prompt)

The changes will take effect only if they are stored using the `nvstore` command, entered at the `ok` prompt. Once the changes are stored, the NVRAM must be enabled before the system will execute it. This is done by setting the environment variable `use-nvramrc?` to `true`.

Elite3D Graphics Accelerator

This chapter describes how to change the Elite3D Graphics Accelerator screen resolution to work properly with different monitors.

You can change the Elite3D X11 screen and associated graphics hardware through the `afbconfig` utility. Options are specified on the command line. The specified options are stored in the `OWconfig` file. You use these options to initialize the Elite3D device the next time Xsun is run on that device. Updating options in the `OWconfig` file provides persistence of these options across Xsun sessions and system reboots.

Note – `afb` is the UNIX device name for the Elite3D family of graphics accelerators.

Use the `afbconfig` utility to specify the following:

- Video mode (screen resolution and refresh rate)
- Type of visuals (linear or nonlinear)
- Whether to use 8-bit pseudocolor visual (overlay visual)
- Whether linear visuals will be reported before their nonlinear counterparts in the screen visuals list
- How to set the default screen visual
- How OpenGL visuals will be supported
- Whether Server Overlay Visuals (SOV) will be available
- The maximum number of Elite3D X channel pixels reserved for use as WIDs
- Whether the pseudocolor overlay visual will come before the pseudocolor underlay visual in the screen visuals list
- Configurable gamma correction by specifying a gamma value or a file containing a gamma-correction table
- Extended overlay option enables a full 256-color overlay and hardware-accelerated transparency visuals

Default Screen Resolutions

The Elite3D system reads the VESA standard Extended Display Identification Data (EDID) from the monitor to determine the default screen resolution. If the EDID data is not available for the monitor, the monitor ID sense code is used to determine the default screen resolution.

<Selempanum lists the default screen resolutions by monitor ID sense code.

TABLE 7-1 Elite 3D Graphics Accelerator Monitor Sense Codes

Code	Screen Resolution
7	1152 x 900 at 66 Hz
6	1152 x 900 at 76 Hz
5	1024 x 768 at 60 Hz
4	1280 x 1024 at 67 Hz
3	1152 x 900 at 66 Hz
2	1280 x 1024 at 76 Hz
1	1152 x 900 at 66 Hz
0	1024 x 768 at 77Hz

If the Elite3D system is unable to determine the monitor type, such as for non-Sun monitors, it defaults to a resolution of 1152 x 900 at 66 Hz.

Supported Screen Resolutions

<Selempanum lists the Elite3D-supported screen resolutions.

TABLE 7-2 Elite 3D-supported Screen Resolutions

Screen Resolution	Vertical Refresh Rate	Description	Video Mode Format	Symbolic Name
1280 x 1024	76 Hz	Non-interlaced	1280x1024x76	1280
1280 x 1024	67 Hz	Non-interlaced	1280x1024x67	
1280 x 1024	60 Hz	Non-interlaced	1280x1024x60	

TABLE 7-2 Elite 3D-supported Screen Resolutions (*Continued*)

Screen Resolution	Vertical Refresh Rate	Description	Video Mode Format	Symbolic Name
1280 x 1024	85 Hz	Non-interlaced	1280x1024x85	
1280 x 800	76 Hz	Non-interlaced	1280x800x76	
1152 x 900	76 Hz	Non-interlaced	1152x900x76	1152
1152 x 900	66 Hz	Non-interlaced	1152x900x66	
1024 x 800	84 Hz	Non-interlaced	1024x800x84	
1024 x 768	77 Hz	Non-interlaced	1024x768x77	
1024 x 768	75 Hz	Non-interlaced	1024x768x75	
1024 x 768	70 Hz	Non-interlaced	1024x768x70	
1024 x 768	60 Hz	SVGA	1024x768x60	svga
960 x 680	112 Hz	Stereo, non-interlaced, 56 Hz field rate per eye	960x680x112s	stereo
960 x 680	108 Hz	Stereo, non-interlaced, 54 Hz field rate per eye	960x680x108s	
768 x 575	50 Hz	Interlaced – PAL	768x575x50i	pal
640 x 480	60 Hz	Interlaced – NTSC	640x480x60i	ntsc
640 x 480	60 Hz	Non-interlaced	640x480x60	

Some monitors may not support some the resolutions supported by the Elite3D system. You can get the list of resolutions supported by the Elite3D and the connected monitor using the `afbconfig` command.

To assure monitor synchronization of supported resolutions, you must install the following Solaris patches before running `afbconfig`. TABLE 7-3 lists the required patches:

TABLE 7-3 Solaris Patches for Elite3D Monitor Synchronization

Solaris Release	Patch
Solaris 2.5.1	105791-30
Solaris 2.6	105363-29
Solaris 2.7	
afb patch	106144-18
xfb patch	106148-11
Solaris 8	N/A

Note – When the `afb` and `xfb` patches are required, you must install both patches as a pair.

Changing Screen Resolutions (`-res`)

▼ To Find Resolutions Supported By Elite3D and the Connected Monitor

- Use the `afbconfig` command as follows:

```
afbconfig -res \?
```

You can change the screen resolution temporarily as a test to determine if the monitor supports the specified resolution.



Caution – Do not change screen resolution while the window system is running. Changing screen resolution while the window system is running may put the screen display in an unusable state.

▼ To Change Screen Resolutions Temporarily

- Use the `afbconfig` command as follows:

```
afbconfig -res video-mode try
```

See `<$elemparamum` for the list of *video-mode* options (see the “Video Mode Format” and “Symbolic Name” columns in the table). You will have five seconds to confirm the video mode by typing `y`.

▼ To Change the Screen Resolution to Stereo

- Enter the following:

```
afbconfig -res stereo
```

This changes the resolution to 960 x 680 at 112 Hz stereo the next time Xsun is run.

Changing Screen Visuals List

The X server screen visuals list can be altered through `afbconfig`. The `afbconfig` options in TABLE 7-4 can be used to configure the list of the exported visuals for the specified device.

TABLE 7-4 The Default Settings of the `afbconfig` Visual Flags

Name	Possible Values	Defaults in Solaris2.5.1/2.5.1 SHWP	Defaults in Solaris 2.6
<code>linearorder</code>	<code>first/last</code>	<code>last</code>	<code>last</code>
<code>deflinear</code>	<code>true/false</code>	<code>false</code>	<code>false</code>
<code>overlayorder</code>	<code>first/last</code>	<code>last</code>	<code>last</code>
<code>defoverlay</code>	<code>true/false</code>	<code>false</code>	<code>false</code>
<code>expvis</code>	<code>enable/disable</code>	<code>disable</code>	<code>enable</code>
<code>sov</code>	<code>enable/disable</code>	<code>disable</code>	<code>enable</code>

Changing the Visual List Order (`-linearorder`, `-overlayorder`)

By default, the nonlinear visual comes before the linear visual on the screen visual list. You can modify the order of the visual list by using the `afbconfig` command.

Most 3D applications require a linear visual. Some 3D applications do not search for a linear visual using `XSolarisGetVisualGamma(3)`. Instead, these applications search the screen visual list for the first 24-bit TrueColor visual they find. To enable

these applications to run with the correct visual, use the `-linearorder` option to change the visual list order so that the linear 24-bit TrueColor visual is the first one the application finds.

The desired visual ordering in the screen visuals list will be available whenever the window system is restarted.

- **To change the setting, enter the `afbconfig` command with one of the `-linearorder` options.**

For example:

```
afbconfig -linearorder first
```

By default, the 8-bit PseudoColor visual comes before the 8-bit PseudoColor Overlay visual on the screen visual list. You can modify the order of the visual list by using the `afbconfig` command.

Some applications that use the 8-bit PseudoColor Overlay visual, search the visual list for the first 8-bit PseudoColor visual they find. To enable these applications to run with the correct visual, use the `-overlayorder` option to change the visual list order so that the 8-bit PseudoColor Overlay visual is the first 8-bit PseudoColor visual the application finds.

The desired visual ordering in the screen visuals list will be available whenever the window system is restarted.

- **To change the setting, enter the `afbconfig` command with one of the `-overlayorder` options.**

For example:

```
afbconfig -overlayorder first
```

Changing the Default Visual (`-deflinear`, `-defoverlay`)

By default, the 8-bit PseudoColor underlay visual is the default visual of the screen. The default visual can be changed to either a linear underlay visual or an overlay visual through `afbconfig`.

- To set the default visual to be a linear visual, enter the `afbconfig` command as follows:

```
afbconfig -deflinear true
```

- To set the default visual to be an overlay visual, enter the `afbconfig` command as follows:

```
afbconfig -defoverlay true
```



Caution – Since there is no linear overlay visual, the user should not specify both “-deflinear true” and “-defoverlay true” simultaneously, or the result will be undefined.



Caution – Note that the visual ordering options (`overlayorder` and `linearorder`) are independent of the default visual options (`defoverlay` and `deflinear`). Moving the overlay visual groups, for example, to the front does not automatically make it a default visual. Some applications make this assumption and hence receive a “BADMATCH” X error when they try to match the colormap created by the default visual and the first 8-bit PseudoColor visual they can find.

Changing OpenGL Visual Support (`-expvis`)

Solaris 2.6 SHWP supports the OpenGL visual expansion. With visual expansion, five visual groups: the 8-bit PseudoColor, 24-bit TrueColor (Linear and Non-Linear), 24-bit DirectColor, and 8-bit PseudoColor Overlay, are expanded from a single visual to multiple visual instances of the same visual type. Different instances of the same visual groups represent different GLX capabilities (e.g., single-buffer or double-buffer capable, monoscopic or stereoscopic capable, or a combination of both). The number of visual instances depends on whether the X server is started in monoscopic or stereoscopic mode.

▼ To Activate OpenGL Visual Support (Visual Expansion)

- Enter the following:

```
afbconfig -expvis enable
```

Changing SERVER_OVERLAY_VISUALS Support (-sov)

SERVER_OVERLAY_VISUALS is one of the root window's properties that contains the visual ID, transparent type, transparent value, and layer of the server overlay visuals (SOV) of the screen. You can toggle the advertisement of this property and the export of the transparent server overlay visuals using `afbconfig`.

▼ To Advertise SERVER_OVERLAY_PROPERTY and Export SOV

- Enter the following:

```
afbconfig -sov enable
```

Setting Gamma Correction (-g, -gfile)

Gamma correction may be set by specifying a gamma correction value or by specifying a file that contains a gamma table.

The `-g` option will set the gamma table entries based on the gamma value specified. A gamma value of 2.22 represents linear gamma correction and matches the fixed value on the Elite3D products. This value is a per-screen value and therefore all gamma corrected or linear visuals will use this value.

▼ To Set the Gamma Correction Using a Value

- Enter the following:

```
afbconfig -g 2.22
```

The `-gfile` option will set the gamma table entries explicitly from a file containing three columns of 256 integers ranging from 0 to 255. The format is three integers separated by a newline character. Each line contains the RGB value to be put in the table for that entry. This value is a per-screen value and therefore all gamma-corrected or linear visuals will use this value.

▼ To Set the Gamma Correction Using a File

- Enter the following:

```
afbconfig -gfile filename
```

Choosing Extended Overlay (-extovl)

In extended overlay mode, the overlay visuals will have 256 opaque colors. The server overlay visuals (SOV) will have 255 opaque colors and one transparent color. The extended overlay mode also enables hardware-accelerated transparency, which provides better performance for windows using the SOV visuals. In extended overlay mode, there are 64 WindowIDs (WIDs) for windows using non-overlay visuals and three WIDs for windows using the overlay visuals.

If extended overlay mode is disabled, the number of colors for overlay visuals is 256 minus the value set for the maxwids option (default 32). The SOV-capable visuals also have (256 - maxwids) colors and a software emulation of transparency.

▼ To Select Extended Overlay Mode

- Enter the following:

```
afbconfig -extovl enable
```

TABLE 7-5 lists the default settings for the `afbconfig -extovl` options.

TABLE 7-5 Default Settings for `afbconfig -extovl` Options

Possible Values	Defaults in Solaris 2.5.1	Defaults in Solaris 2.6
enable/disable	disable	enable

Choosing the Number of WIDs and Colors in the Overlay (-maxwids)

This option is available only if the extended overlay mode is disabled. This `maxwids` option specifies the maximum number of Elite3D X channel pixel values that are reserved for use as window IDs (WIDs). The remaining pixel values are the number of colors available for overlay windows. The legal values for the `maxwids` option are 1, 2, 4, 8, 16, 32, or 64.

▼ To Select the Number of WIDs

- Enter the following:

```
afbconfig -maxwids number_of_WIDs
```

TABLE 7-6 lists the default settings for `afbconfig -maxwids` options.

TABLE 7-6 Default Settings for `afbconfig -maxwids` Options

Possible Values	Defaults in Solaris 2.5.1	Defaults in Solaris 2.6
1, 2, 4, 8, 16, 32, 64	32	Not available

Impact on Screen Visual List by Various `afbconfig` Visual Flags

Effect on the Default Visual and the Visual Group Ordering

In summary, the appearance of the X server screen visual list can be changed to fit the user's needs using any of the `afbconfig` visual flags (e.g., `linearorder`, `overlayorder`, `expvis`, `sov`, etc.). This section briefly shows the effect of these visual options on the visual list.

Without any alteration using `afbconfig`, the X server screen visual list can roughly be categorized in the following visual groups and order:

- 8-bit PseudoColor
- 8-bit Miscellaneous (StaticColor, Non-linear StaticGray, etc)
- 8-bit Linear StaticGray
- 8-bit PseudoColor Overlay
- 24-bit Non-linear TrueColor
- 24-bit DirectColor
- 24-bit Linear TrueColor

The default screen visual will be the 8-bit PseudoColor visual. The `deflinear` and `defoverlay` options will alter this pointer to point to the first 8- or 24-bit linear visual, depending on the X server depth when it starts up, and the first 8-bit overlay visual, respectively. You can rearrange the entire “8-bit PseudoColor Overlay” group, the “8-bit Linear StaticGray” group, and the “24-bit Linear TrueColor” group to be ahead of all other visual groups of the same depth by using the `linearorder` and `overlayorder` flags. For example, if you specify the following:

```
afbcfg -overlayorder first
```

The screen visuals list will be rearranged in the following order:

- 8-bit PseudoColor Overlay
- 8-bit PseudoColor
- 8-bit Miscellaneous (StaticColor, Non-linear StaticGray, etc.)
- 8-bit Linear StaticGray
- 24-bit Non-linear TrueColor
- 24-bit DirectColor
- 24-bit Linear TrueColor

Effect on the Number of Visual Instances Within Selected Groups

The `expv` flag will change the number of visual instances in the following visual groups:

- 8-bit PseudoColor
- 8-bit PseudoColor Overlay
- 24-bit Non-linear TrueColor
- 24-bit DirectColor
- 24-bit Linear TrueColor

The number of instances that `expv` will alter depends on whether the monitor is in monoscopic or stereoscopic resolution. In monoscopic resolution, if `expv` is enabled, the order of the screen visual groups will be preserved, but within each group mentioned above, a “double-buffer capable” visual instance will be added. In stereoscopic resolution, two additional visual instances: “double-buffer, stereo capable” and “single-buffer, stereo capable”, will be added. The “double-buffer capable” visual instances, if present, will always come ahead of the “single-buffer capable” visual instances, and the monoscopic visual instances will always come ahead of the stereoscopic ones.

For example, if you specify the following in stereoscopic resolution:

```
afbconfig -overlayorder first -expvis enable
```

the screen visual list will be:

- 8-bit PseudoColor Overlay (Mono, Stereo)
- 8-bit PseudoColor (DB Mono, SB Mono, DB Stereo, SB Stereo)
- 8-bit Miscellaneous (StaticColor, Non-linear StaticGray... etc)
- 8-bit Linear StaticGray
- 24-bit Linear TrueColor (DB Mono, SB Mono, DB Stereo, SB Stereo)
- 24-bit Non-linear TrueColor (DB Mono, SB Mono, DB Stereo, SB Stereo)
- 24-bit DirectColor (DB Mono, SB Mono, DB Stereo, SB Stereo)

Note – There is no double-buffer capable overlay visual instance.

Addition of the SERVER_OVERLAY_VISUALS Property and the Transparent SOV Visuals in the 8-bit Overlay Group

Without the `sov` option being enabled, the only overlay visuals available are the ones without transparency. Enabling the `sov` option will add the transparent SOV visual instances into the screen visual list and also add the `SERVER_OVERLAY_VISUALS` property to the root window property. The transparent SOV visual instances belong to the “8-bit PseudoColor Overlay” visual group. The `SERVER_OVERLAY_VISUALS` property will contain the visuals’ ID, transparent type, value, and layer of all available overlay visuals of the screen.

For example, if you specify the following in stereoscopic resolution:

```
afbconfig -overlayorder first -expvis enable -sov enable
```

the screen visuals list will be:

- 8-bit PseudoColor Overlay (Mono, Stereo, Mono SOV, Stereo SOV)
- 8-bit PseudoColor (DB Mono, SB Mono, DB Stereo, SB Stereo)
- 8-bit Miscellaneous (StaticColor, Non-linear StaticGray, etc.)
- 8-bit Linear StaticGray
- 24-bit Linear TrueColor (DB Mono, SB Mono, DB Stereo, SB Stereo)

- 24-bit Non-linear TrueColor (DB Mono, SB Mono, DB Stereo, SB Stereo)
- 24-bit DirectColor (DB Mono, SB Mono, DB Stereo, SB Stereo)

and the SERVER_OVERLAY_VISUALS property will contain the following information:

```

=====
                        SERVER OVERLAY VISUALS (SOV) Info
=====
No. of SOV visuals = 4
SOV #0, ID 0x36, TRANSPARENT_TYPE 0, VALUE 0, LAYER 1
SOV #1, ID 0x37, TRANSPARENT_TYPE 0, VALUE 0, LAYER 1
SOV #2, ID 0x38, TRANSPARENT_TYPE 1, VALUE 255, LAYER 1
SOV #3, ID 0x39, TRANSPARENT_TYPE 1, VALUE 255, LAYER 1
=====

```



Stereo Connector

The stereo connector allows connection of stereo goggles to the Elite3D Graphics Accelerator. The stereo connector for the Elite3D board is a seven-pin DIN connector as shown in FIGURE 7-1.

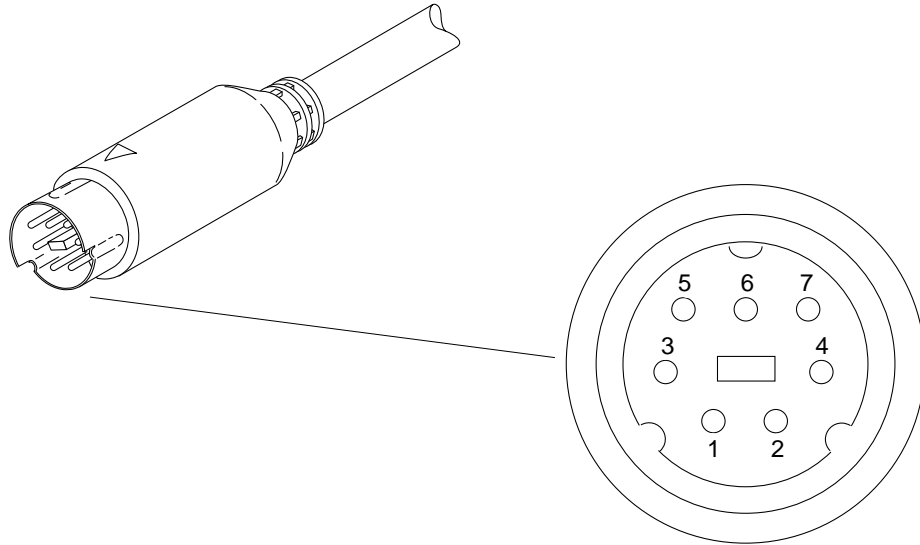

FIGURE 7-1 Elite3D Stereo Connector

TABLE 7-7 lists the stereo cable signals.

TABLE 7-7 Elite3D Stereo Connector Signals

Pin	Description
1	Ground
2	No connection
3	+12V
4	STEREO signal
5	No connection
6	No connection
7	No connection

Stereo Signal

The STEREO signal is a TTL-level, 50 percent duty cycle signal that switches between left and right stereo shutters, as shown in FIGURE 7-2.

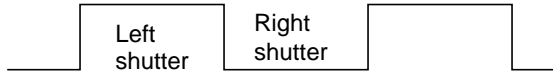

FIGURE 7-2 Elite3D Stereo Signal

A stereo cable and goggles for use with the Elite3D Graphics Accelerator are available from the following source:

StereoGraphics Corporation
2171-H East Francisco Blvd.
San Rafael, CA 94901
(415) 459-4500
FAX: 415-459-3020

Expert3D Graphics Accelerator

This chapter describes how to change the Sun Expert3D Graphics Accelerator screen resolution to work properly with different monitors. It also describes the Expert3D internal and external connectors and their use.

Note – The Expert3D-Lite software packages and configuration utilities are the same as the Expert3D graphics card.

The Expert3D graphics accelerator is a high-resolution, high-performance graphics frame buffer that provides hardware texture mapping. The Expert3D system only, supports screen resolutions up to 1920 x 1200, double-buffered, z-buffered, and 1280 x 1024 stereo.

Note – `ifb` is the UNIX device name for the Expert3D Graphics Accelerator.

Configuration Utilities

Two configuration utilities are available for the Expert3D Graphics Accelerator: `fbconfig` and `SUNWifb_config`.

The `fbconfig` Utility

The `fbconfig` utility is a generic command line interface to query and configure frame buffer attributes. `fbconfig` works with the Creator3D and Elite3D graphics accelerators, in addition to the Expert3D.

The `fbconfig` utility can be used to do the following:

- Print a list of the installed frame buffers and the associated device-specific configuration utilities that can be used
- Any of the uses described for the `SUNWifb_config` utility.

For more information on `fbconfig`, see the `fbconfig` man page.

The `SUNWifb_config` Utility

The `SUNWifb_config` utility is specific to Expert3D; it cannot be used with any other frame buffers. You can use the `SUNWifb_config` utility to:

- Specify a different screen resolution
- Type of visuals (linear or nonlinear)
- Whether to use 8-bit pseudocolor visual (overlay visual)
- Whether linear visuals will be reported before their nonlinear counterparts in the screen visuals list
- How to set the default screen visual
- How OpenGL visuals will be supported
- Specify whether Server Overlay Visuals (SOV) will be available
- Enable slave mode so that the video from this frame buffer will be synced with the video of the display that is connected to it
- Enable stereo mode
- Enable frame buffer memory to be allocated for accelerated accumulation buffer for windows
- Configurable gamma correction by specifying a gamma value or a file containing a gamma-correction table

For more information, see the `SUNWifb_config` man page.

Default Screen Resolutions

For most installations, the Expert3D automatically configures itself to the proper screen resolution and refresh rate for the attached monitor. However, if a non-Sun monitor is attached to the Expert3D, the monitor may not have the proper screen resolution.

TABLE 8-1 lists the default screen resolutions by monitor sense code.

TABLE 8-1 Expert3D Graphics Accelerator Monitor Sense Codes

Code	Screen Resolution
7	1152 x 900 at 66 Hz
6	1152 x 900 at 76 Hz
5	1024 x 768 at 60 Hz
4	1280 x 1024 at 67 Hz
3	1152 x 900 at 66 Hz
2	1280 x 1024 at 76 Hz
1	1152 x 900 at 66 Hz
0	1024 x 768 at 77Hz

If the Expert3D system is unable to determine the monitor type, such as for non-Sun monitors, it defaults to a resolution of 1152 x 900 at 66 Hz.

Supported Screen Resolutions

<selemparanum lists the Expert3D-supported screen resolutions. The `fbconfig` or `SUNwifb_config` utilities can be used to set the Expert3D system to any one of these resolutions.

TABLE 8-2 Expert3D-supported Screen Resolutions

Screen Resolution	Vertical Refresh Rate	Description	Video Mode Format	Symbolic Name
1920 x 1200	75 Hz	Non-interlaced	1920x1200x75	
1920 x 1200	70 Hz	Non-interlaced	1920x1200x70	
1920 x 1080	76 Hz	Non-interlaced	1920x1080x76	
1920 x 1080	72 Hz	Non-interlaced	1920x1080x72	
1792 x 1344	75 Hz	Non-interlaced	1792x1344x75	
1600 x 1280	76 Hz	Non-interlaced	1600x1280x76	
1600 x 1000	76 Hz	Non-interlaced	1600x1000x76	
1600 x 1000	66 Hz	Non-interlaced	1600x1000x66	

TABLE 8-2 Expert3D-supported Screen Resolutions (*Continued*)

Screen Resolution	Vertical Refresh Rate	Description	Video Mode Format	Symbolic Name
1440 x 900	76 Hz	Non-interlaced	1440x900x76	
1280 x 1024	112 Hz	Stereo, non-interlaced, 56 Hz field rate per eye	1280x1024x112	
1280 x 1024	85 Hz	Non-interlaced	1280x1024x85	
1280 x 800	76 Hz	Non-interlaced	1280x800x76	1280
1280 x 1024	67 Hz	Non-interlaced	1280x1024x67	
1280 x 1024	60 Hz	Non-interlaced	1280x1024x60	
1280 x 800	76 Hz	Non-interlaced, Creator	1280x800x76	
1152 x 900	76 Hz	Non-interlaced	1152x900x76	1152
1152 x 900	66 Hz	Non-interlaced	1152x900x66	
1024 x 768	77 Hz	Non-interlaced	1024x768x77	
1024 x 768	75 Hz	Non-interlaced	1024x768x75	
1024 x 768	70 Hz	Non-interlaced	1024x768x70	
1024 x 768	60 Hz	SVGA	1024x768x60	svga
960 x 680	112 Hz	Stereo, non-interlaced, 56 Hz field rate per eye	960x680x112s	stereo
960 x 680	108 Hz	Stereo, non-interlaced, 54 Hz field rate per eye	960x680x108s	
768 x 575	50 Hz	Interlaced – PAL	768x575x50i	pal
640 x 480	60 Hz	Interlaced – NTSC	640x480x60i	ntsc
640 x 480	60 Hz	Non-interlaced	640x480x60	

Changing Screen Resolutions (-res)

▼ To Find Resolutions Supported By Expert3D and the Connected Monitor

- Use the `SUNwifb_config` command as follows:

```
SUNwifb_config -res \?
```

You can change the screen resolution temporarily as a test to determine if the monitor supports the specified resolution.

Caution – Do not change screen resolution while the window system is running. Changing screen resolution while the window system is running may put the screen display in an unusable state.

▼ To Change Screen Resolutions Temporarily

- Use the `SUNwifb_config` command as follows:

```
SUNwifb_config -res video-modetry
```

See `<$lemparanum` for the list of *video-mode* options (see the “Video Mode Format” and “Symbolic Name” columns in the table). You will have five seconds to confirm the video mode by typing `y`.

▼ To Change the Screen Resolution to Stereo

- Enter the following:

```
SUNwifb_config -res stereo
```

This changes the resolution to 960 x 680 at 112 Hz stereo the next time Xsun is run.

Changing Screen Visuals List

The X server screen visuals list can be altered through `SUNwifb_config`. The `SUNwifb_config` options in TABLE 8-3 can be used to configure the list of the exported visuals for the specified device.

TABLE 8-3 The Default Settings of the `SUNwifb_config` Visual Flags

Name	Possible Values	Defaults
<code>linearorder</code>	<code>first/last</code>	<code>last</code>
<code>deflinear</code>	<code>true/false</code>	<code>false</code>
<code>overlayorder</code>	<code>first/last</code>	<code>last</code>
<code>defoverlay</code>	<code>true/false</code>	<code>false</code>
<code>expvis</code>	<code>enable/disable</code>	<code>enable</code>
<code>sov</code>	<code>enable/disable</code>	<code>enable</code>

Changing the Visual List Order (`-linearorder`, `-overlayorder`)

By default, the nonlinear visual comes before the linear visual on the screen visual list. You can modify the order of the visual list by using the `SUNwifb_config` command.

Most 3D applications require a linear visual. Some 3D applications do not search for a linear visual using `XSolarisGetVisualGamma(3)`. Instead, these applications search the screen visual list for the first 24-bit TrueColor visual they find. To enable these applications to run with the correct visual, use the `-linearorder` option to change the visual list order so that the linear 24-bit TrueColor visual is the first one the application finds.

The desired visual ordering in the screen visuals list will be available whenever the window system is restarted.

- **To change the setting, enter the `SUNwifb_config` command with one of the `-linearorder` options.**

For example:

```
SUNwifb_config -linearorder first
```

By default, the 8-bit PseudoColor visual comes before the 8-bit PseudoColor Overlay visual on the screen visual list. You can modify the order of the visual list by using the `SUNWifb_config` command.

Some applications that use the 8-bit PseudoColor Overlay visual, search the visual list for the first 8-bit PseudoColor visual they find. To enable these applications to run with the correct visual, use the `-overlayorder` option to change the visual list order so that the 8-bit PseudoColor Overlay visual is the first 8-bit PseudoColor visual the application finds.

The desired visual ordering in the screen visuals list will be available whenever the window system is restarted.

- **To change the setting, enter the `SUNWifb_config` command with one of the `-overlayorder` options.**

For example:

```
SUNWifb_config -overlayorder first
```

Changing the Default Visual (`-deflinear`, `-defoverlay`)

By default, the 8-bit PseudoColor underlay visual is the default visual of the screen. The default visual can be changed to either a linear underlay visual or an overlay visual through `SUNWifb_config`.

- **To set the default visual to be a linear visual, enter the `SUNWifb_config` command as follows:**

```
SUNWifb_config -deflinear true
```

- **To set the default visual to be an overlay visual, enter the `SUNWifb_config` command as follows:**

```
SUNWifb_config -defoverlay true
```

Caution – Since there is no linear overlay visual, the user should not specify both “`-deflinear true`” and “`-defoverlay true`” simultaneously, or the result will be undefined.

Caution – Note that the visual ordering options (`overlayorder` and `linearorder`) are independent of the default visual options (`defoverlay` and `deflinear`). Moving the overlay visual groups, for example, to the front does not automatically make it a default visual. Some applications make this assumption and hence receive a “BADMATCH” X error when they try to match the colormap created by the default visual and the first 8-bit PseudoColor visual they can find.

Changing OpenGL Visual Support (`-expvis`)

Solaris supports the OpenGL visual expansion. With visual expansion, five visual groups: the 8-bit PseudoColor, 24-bit TrueColor (Linear and Non-Linear), 24-bit DirectColor, and 8-bit PseudoColor Overlay, are expanded from a single visual to multiple visual instances of the same visual type. Different instances of the same visual groups represent different GLX capabilities (e.g. single-buffer or double-buffer capable, monoscopic or stereoscopic capable, or a combination of both). The number of visual instances depends on whether the X server is started in monoscopic or stereoscopic mode.

▼ To Activate OpenGL Visual Support (Visual Expansion)

- Enter the following:

```
SUNWifb_config -expvis enable
```

Changing `SERVER_OVERLAY_VISUALS` Support (`-sov`)

`SERVER_OVERLAY_VISUALS` is one of the root window’s properties that contains the visual ID, transparent type, transparent value, and layer of the server overlay visuals (SOV) of the screen. You can toggle the advertisement of this property and the export of the transparent server overlay visuals using `SUNWifb_config`.

▼ To Advertise `SERVER_OVERLAY_PROPERTY` and Export SOV

- Enter the following:

```
SUNWifb_config -sov enable
```

Setting Gamma Correction (`-g`, `-gfile`)

Gamma correction may be set by specifying a gamma correction value or by specifying a file that contains a gamma table.

The `-g` option will set the gamma table entries based on the gamma value specified. A gamma value of 2.22 represents linear gamma correction and matches the fixed value on the Expert3D system. This value is a per-screen value and therefore all gamma corrected or linear visuals will use this value.

▼ To Set the Gamma Correction Using a Value

- Enter the following:

```
SUNWifb_config -g 2.22
```

The `-gfile` option will set the gamma table entries explicitly from a file containing three columns of 256 integers ranging from 0 to 255. The format is three integers separated by a newline character. Each line contains the RGB value to be put in the table for that entry. This value is a per-screen value and therefore all gamma-corrected or linear visuals will use this value.

▼ To Set the Gamma Correction Using a File

- Enter the following:

```
SUNWifb_config -gfile filename
```

Choosing Extended Overlay (-extovl)

Enabling the extended overlay option will switch the Expert3D system to the extended overlay functionality. The extended overlay mode enables full 256-color overlays and hardware-accelerated Server Overlay Visuals. The maximum number of underlay Window IDs (WIDs) is increased from 32 to 64 and three new overlay WIDs are provided.

▼ To Configure for Extended Overlay Mode

- Enter the following:

```
SUNWifb_config -extovl enable
```

Multiple Monitor Configuration

To run more than one frame buffer, you need to modify your `/etc/config/Xservers` file. The Expert3D device is identified as `ifbx` (for example, `ifb0` and `ifb1` for two Expert3D devices). To do this:

1. **Become superuser and open the `/etc/dt/config/Xservers` file.**

```
# cd /etc/dt/config
# vi Xservers
```

2. Modify the file by adding the device locations for the applicable frame buffers being used.

The following example shows the Xservers configuration file modified for one Creator card and two Expert3D cards:

```
:0 Local local_uid@console root /usr/openwin/bin/Xsun :0 -dev /dev/fbs/ffb0  
-dev /dev/fbs/ifb1 -dev /dev/fbs/ifb0 -nobanner
```

See “Multiview Ports” on page 113 for information on configuring multiple Expert3D cards in a single system.

Defining the Expert3D Card as the Default Console

On a multiple-monitor system, you may wish to define which of the monitors is your default console. To make your Expert3D card be the default console display:

1. At the OpenBoot prompt, type the following:

```
ok show_displays
```

The Expert3D system will output a list of the available frame buffers, similar to the following:

```
a) /PCI@@11, 2000/SUNW,Expert3D@1
b) /PCI@@15, 2000/SUNW,afb@1
q) NO SELECTION
```

The Expert3D-Lite system will output a list of the available frame buffers, similar to the following:

```
a) /pci@1f,0/SUNW,m64B@13
b) /pci@1f,0/pci@5/SUNW,Expert3D@1
q) NO SELECTION
Enter Selection, q to quit: b
/pci@1f,0/pci@5/SUNW,Expert3D@1 has been selected.
Type ^Y ( Control-Y ) to insert it in the command line.
e.g. ok nvalias mydev ^Y
    for creating devalias mydev for
/pci@1f,0/pci@5/SUNW,Expert3D@1
ok nvalias myscreen /pci@1f,0/pci@5/SUNW,Expert3D@1
ok setenv output-device myscreen
output-device =          myscreen
```

2. Select the option for the device you want to use as the console.

In the above example, you would select option **a** if you want to make the Expert3D device be the console.

3. Set this device to be the console device.

At the OpenBoot prompt, enter the following:

```
ok setenv output-device <Control-Y> <ENTER>
ok reset
```

You can also create an alias for the Expert3D system to simplify future OpenBoot commands. After running the `show-displays` command and choosing the Expert3D device from the menu, type the following:

```
ok nvalias screen1 <Control-Y>
ok nvstore
```

To verify that this alias is correctly set, type the following:

```
ok devaliases
```

You can then refer to `screen1` for the Expert3D device. For example:

```
ok setenv output-device screen1
```

Expert3D External I/O Connectors

The Expert3D board has both internal and external I/O connectors. The internal connectors are used for multiviewing and the external ports are used for external video synchronization and stereo. FIGURE 8-1 shows the external I/O connectors.

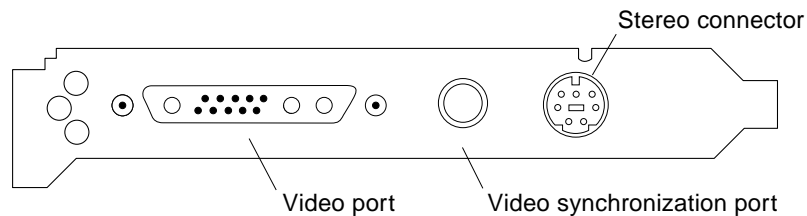

FIGURE 8-1 Expert3D External I/O Port Connectors

FIGURE 8-2 shows the Expert3D-Lite I/O port connectors. The Expert3D-Lite graphics card does not support external video synchronization. The Expert3D-Lite installation kit provides an HD15 to 13W3 monitor adaptor cable.

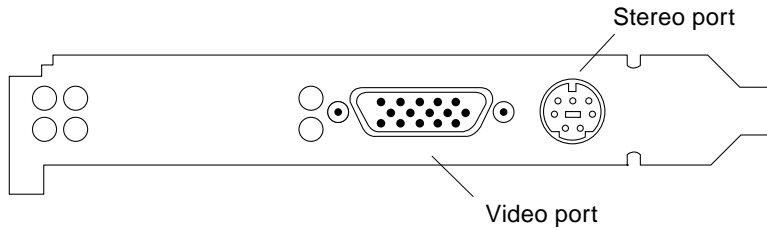

FIGURE 8-2 Expert3D-Lite External I/O Port Connectors

Stereo Connector

The stereo connector allows connection of stereo goggles to the Expert3D Graphics Accelerator. The stereo connector is a seven-pin DIN connector, as shown in FIGURE 8-3.

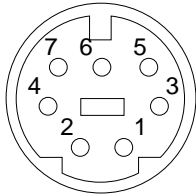

FIGURE 8-3 Expert3D Stereo Connector

<selemparanum lists the stereo cable signals.

TABLE 8-4 Expert3D Stereo Connector Signals

Pin	Description
1	Ground
2	5.0V (fused, will supply up to 300 mA, limited to 1.0A)
3	+12V (fused, will supply up to 300 mA, limited to 1.0A)
4	STEREO signal
5	No connection
6	No connection
7	No connection

The STEREO signal is a TTL-level, 50 percent duty cycle signal that switches between left and right stereo shutters, as shown in FIGURE 8-4.

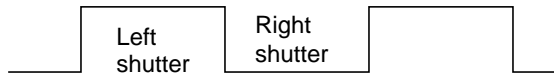

FIGURE 8-4 Expert3D Stereo Signal

A stereo cable and goggles for use with the Expert3D Graphics Accelerator are available from the following source:

StereoGraphics Corporation
2171-H East Francisco Blvd.
San Rafael, CA 94901
(415) 459-4500
FAX: 415-459-3020

Video Synchronization Port (Expert3D Only)

The video synchronization port provides an input to the Expert3D board used to provide a periodic signal to which the display system attempts to lock its vertical refresh rate. This port uses a 75 ohm BNC male connector. A 75 ohm coax cable terminated with a female BNC connector is needed to connect to this port.

The video synchronization port supports the following formats:

- NTSC composite video
- PAL composite video
- TTL, LVTTTL, or CMOS-level compatible signal (50 Hz to 180 Hz), with a minimum low or high pulse of 100 nS (TBV)

Multiview Ports

The internal Multiview In and Multiview Out ports on the Expert3D card, shown as J1 and J2 in FIGURE 8-5, are used for cable connections from one Expert3D card to another. These ports are accessible only inside the system chassis.

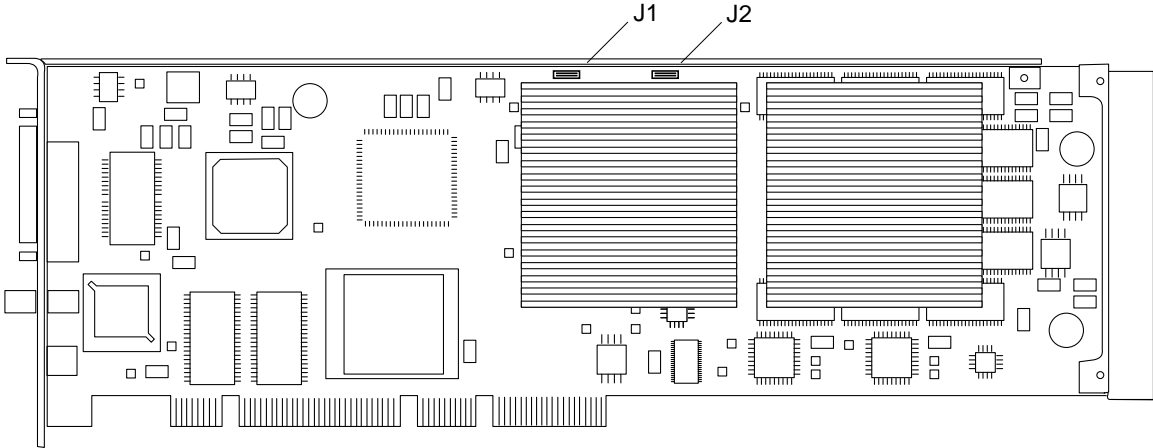

FIGURE 8-5 Expert3D Multiview In and Multiview Out Connectors

Configuring Multiple Expert3D Graphics Cards

You can frame lock only two Expert3D cards for multiviewing. When two Expert3D cards are used in a multiviewing configuration, one of the cards is designated as the *master* and the other as the *slave*.

- When your system is first started, Solaris places all Expert3D cards in the system in master mode. To use the Expert3D cards for multiviewing, use the `SUNWifb_config` utility to set one of the cards to be the slave.
- There can only be one master Expert3D card in a system.
- You must choose a screen resolution supported by Expert3D and assure that each Expert3D monitor in frame lock is set to that resolution.
- Refer to the `boot` man page for device location and device numbering information for how devices are numbered based on their physical location. You may select any device (that is, `ifb0` or `ifb1`) to be the master Expert3D device.

To configure two Expert3D cards for multiviewing through frame locking:

- 1. Select an Expert3D card to designate as the master for the system.**

One solution for designating an Expert3D to be the master is to use the Expert3D card that serves as the boot/console head for the system.

2. Make sure that each Expert3D card installed has the same screen resolution as the Expert3D in the master mode.

If the resolution on each Expert3D card is not the same, you must change it to match the Expert3D in master mode.

To check the resolution of an Expert3D card, use the `SUNWifb_config` utility. For example:

```
% SUNWifb_config -dev /dev/fbs/ifb0 -prconf
```

You must repeat this command for each Expert3D card in the system.

The `SUNWifb_config` utility displays the current screen resolution setting. It also displays additional information, such as whether the Expert3D card is a master or a slave.

If you need to change the resolution of an Expert3D card, use the `SUNWifb_config` utility. For example:

```
% SUNWifb_config -dev /dev/fbs/ifb1 -res 1280x1024x76 now nocheck
```

3. Connect the frame lock multiview cable to each Expert3D card.

See FIGURE 8-5.

- a. **Connect the top of the multiview frame lock cable assembly to the Multiview-out J2 connector of the master Expert3D card.**
- b. **Connect the other end of the multiview frame lock cable to the Multiview-in J1 connector of the slave Expert3D card.**

4. From the master Expert3D card display window, configure the other Expert3D card in slave mode.

To do this, use the `SUNWifb_config` utility.

```
% SUNWifb_config -dev /dev/fbs/ifb1 -slave on
```

You must configure each card separately.

Your system is now ready for frame lock and buffer swap synchronization software applications.

To reconfigure your Expert3D card from slave mode back to master mode, do one of the following:

- Power cycle the system.

- Use the `SUNwifb_config` utility. For example:

```
% SUNwifb_config -dev /dev/fbs/ifb1 -slave off
```

You must configure each card in slave mode separately.

Multiple Monitors on a System

This chapter describes how to use multiple monitors on a SPARCstation system. Skip this chapter if you do not run multiple monitors on your system.

Most SPARCstations and UltraSPARC systems support multiple monitor configurations, providing that additional SBus slots (or PCI slots for some systems) are available.

The procedures described in this chapter require some knowledge of UNIX and basic editing tools such as `vi` or `emacs`.

Multiple Monitor Configuration

Sun Ultra Systems

To run more than one framebuffer, you need to modify your `/etc/dt/config/Xservers` file. Identify the device name for the frame buffers you are using. To do this:

- 1. Become superuser and open the `/etc/dt/config/Xservers` file.**

```
# cd /etc/dt/config
# vi Xservers
```

- 2. Modify the file by adding the device locations for the applicable frame buffers being used.**

The following example shows the `Xservers` configuration file modified for one Creator (`ffb0`) card and two Expert3D cards (`ifb0` and `ifb1`):

```
:0 Local local_uid@console root /usr/openwin/bin/Xsun :0 -dev /dev/fbs/ffb0
-dev /dev/fbs/ifb1 -dev /dev/fbs/ifb0 -nobanner
```

Sun SPARCstation SBus Systems

When the system is booted, it looks for the `sbus-probe-list`, which determines the order in which the SBus devices are addressed. For the SPARCstation 10, SBus address `f` is reserved for the CPU and should always be the first address in the `sbus-probe-list`.

To determine the system information and `sbus-probe-list`, type:

```
% eeprom
.
.
.
sbus-probe-list=0123
.
.
```

The addressing numbers are 0, 1, 2, and 3. However, 0 is reserved for the CPU and should always be the first address in the `sbus-probe-list` for all SPARCstation systems except the SPARCstation 10 system.

The following system information and `sbus-probe-list` (starting with `f`) will be displayed if you have a SPARCstation 10 system:

```
% eeprom
.
.
.
sbus-probe-list=f0123
.
.
```

Device File Names

If you are using OpenWindows™ software on multiple monitors, you should be familiar with the way frame buffer devices are assigned to UNIX device file names. Multiple frame buffers used with OpenWindows software require that you supply UNIX device file names for frame buffers on the command line when either is started.

The UNIX boot messages identify the frame buffer as `/dev/fb` (where `fb` is the type of frame buffer). The `/dev/fb` usually has another device file name such as `/dev/fbs/cgsix0`, `/dev/fbs/bwtwo0`, or `/dev/fbs/leo0`, depending on the type of frame buffer. When a second frame buffer is added, the system decides which is `/dev/fb` based on the SBus slot number of each frame buffer and the `sbus-probe-list` EEPROM variable. The `/dev/fb` is the frame buffer in the first SBus slot defined in the `sbus-probe-list`.

If a TurboGXplus card is added to the system with an existing GX frame buffer, the `sbus-probe-list` also determines which is `/dev/fbs/cgsix0` and which is `/dev/fbs/cgsix1`.

For example, assume that the `sbus-probe-list` on a SPARCstation 10 system has the default value of `f0123` and that SBus slots 2 and 3 contain TurboGXplus cards. The TurboGXplus card in slot 2 will be known as `/dev/fb` and `/dev/fbs/cgsix0`; the TurboGXplus card in slot 3 will be known as `/dev/fbs/cgsix1`.

The command line examples shown in this chapter use possible device file names to refer to frame buffers. Substitute the device file name that is appropriate for your system.

Checking the Available Frame Buffers

If you do not know the names of the frame buffer devices in your system, check them by entering:

```
% /etc/dmesg | more
```

The system configuration is displayed, including the types of available frame buffers in your system and the slots they occupy. The list of messages might be lengthy. Look for the lines that start with `cg` or `leo` (for color frame buffers) and `bw` (for black and white frame buffers).

```
.
.
cgsix0 at SBus0: SBus slot 1 0x0 SBus level 5 sparc ipl 7
cgsix0 is /sbus@1,f8000000/chsix@1,0
cgsix0: screen 1152x900, single buffered, 1M mappable, rev1
.
.
```

Note – Executing the `dmesg` command may result in numerous messages. The system configuration messages shown below may not even be displayed. In this case, reboot your system. After rebooting, repeat the command shown previously.

Starting OpenWindows from the Console

The following is an example of a `.login` file configured to start OpenWindows from the console.

```
#
# if possible, start the windows system. Give user a chance to bail out
#
if ( `tty` == "/dev/console" && $TERM == "sun" ) then
  if ( ${?OPENWINHOME} == 0 ) then
    setenv OPENWINHOME /usr/openwin
  endif
  echo ""
  echo -n "Starting OpenWindows in 5 seconds (type Control-C to interrupt)"
  sleep 5
  echo ""
  $OPENWINHOME/bin/openwin
  clear      # get rid of annoying cursor rectangle
  logout    # logout after leaving windows system
endif
```

Running OpenWindows on Multiple Monitors

To run multiple monitors with OpenWindows Version 3

1. **Set up the OpenWindows Version 3 environment by typing the following command (use the actual pathname for `/usr/local` where OpenWindows Version 3 software is located):**

```
% setenv OPENWINHOME [/usr/local/openwin]
```

2. **Verify that a device file already exists for the desired frame buffer by typing:**

```
# ls -l /dev/fbs/cgsix1
```

If the device file already exists, a message similar to the one shown below is displayed. If so, skip Steps 3, 4, and 5 and go to Step 6. If the "not found" message is displayed, continue to Step 3.

```
crw-rw-rw- 1 root      67,   0 Jan 10 1991 /dev/fbs/cgsix1
```

3. **Become superuser, halt the system, and perform a reconfiguration boot, as follows:**

```
# boot -r
```

The system probes all of the attached hardware devices and creates the device file for the second frame buffer.

4. **Verify the newly created file by typing:**

```
# ls -l /dev/fbs/cgsix1
```

A message similar to the following is displayed, indicating that the device file was successfully created:

```
crw-rw-rw- 1 root      67,   0 Jan 10 1991 /dev/fbs/cgsix1
```

5. Exit the superuser mode.

6. Specify the screens that you want to run by typing:

```
% $OPENWINHOME/bin/openwin -dev /dev/fb -dev /dev/fbs/cgsix1
```

Note – The order in which the devices are listed is important. The first device corresponds to the left screen; the second device corresponds to the right screen. The names of your devices (for example, `/dev/fbs/cgsix1`) may differ. Use the device file name that is appropriate for your system.

Changing the Polling Order

This section provides information about the SBus polling order and how to change it. Skip this section if you know the order in which the SBus devices are addressed, or if you do not want to change the current order.

SBus Addresses

Two-slot SPARCstation systems, such as the SPARCstation IPX and LX, have four SBus addresses: 0, 1, 2, and 3. SBus address 0 is located on the main logic board and is reserved for system use. SBus slots (SBus addresses) 1 and 2 are for customer-installable SBus cards. SBus slots 1 and 2 are the only physical slots. SBus address 3 is the frame buffer on the main logic board.

The SPARCstation 2 system has no on-board frame buffer. Slots 1, 2, and 3 in this system are used to install SBus cards.

There is also no on-board frame buffer on the SPARCstation 10 and SPARCstation 20 systems. SBus address `f` is reserved for the CPU and should always be the first address in the `sbus-probe-list`. In SPARCstation 10 and 20 systems, SBus address lines 0, 1, 2, and 3 are used for customer-installable SBus cards.

Polling Order

The polling order is determined by the `sbus-probe-list` parameter in the system OpenBoot™ PROM. For the SPARCstation 10 and 20 systems, you must begin with `f`. This parameter is set up to poll the slots in order from 0 to 3. You can change the order of slots 1, 2, and 3, but you must begin with slot 0.

For example, if you install a frame buffer card into an SBus slot in SPARCclassic™, SPARCstation IPX, and SPARCstation LX systems, the system looks first for the frame buffer at the SBus slot rather than on the on-board frame buffer. If it finds a frame buffer at an SBus slot, the system establishes the video connection at that slot and looks no further. To have the system look first at the on-board frame buffer, you have to change the polling order to 0, 3, 1, 2.

Note – If you change the `sbus-probe-list` in a SPARCstation IPX or LX system and select 3 as the console device, make sure that a monitor is attached to the on-board frame buffer. Otherwise, the system will not recognize any other monitor regardless of polling order.

Changing the `sbus-probe-list`

The following procedure describes how to change the `sbus-probe-list`.



Caution – The procedure described in this section is for experienced SunOS™ software users only. If you have only one monitor or do not need to change the probe list, do not follow this procedure. Any changes made to the system information displayed after typing the `eeprom` command will alter the system configuration.

To change the `sbus-probe-list`

● **As superuser, type:**

```
# eeprom sbus-probe-list=0xyz (or fwxyz for a SPARCstation 10 system)
```

where xyz or wxyz is the order of SBus slots to be probed.

For example, in a SPARCclassic, SPARCstation IPX, and SPARCstation LX configuration, 0312 would cause SBus slot 3 (on-board frame buffer) to be probed first. After slot 3 is probed, SBus slots 1 and 2 will be probed, respectively. Here is what you would type for this example

```
# eeprom sbus-probe-list=0312
```

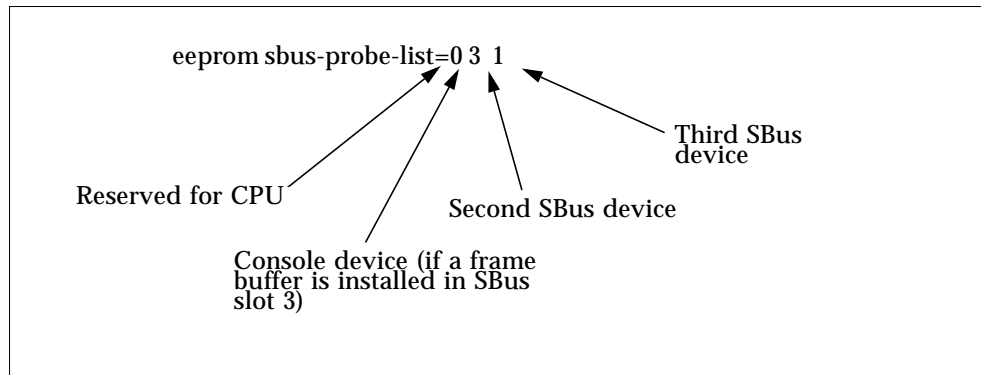

FIGURE 9-1 SBus Probe List Explanation

The leftmost character, except 0, in `eeprom sbus-probe-list` indicates the device that will be probed first. This will be the console device, regardless of its physical location.

Note – If you are using a SPARCstation 10 or 20 system, the leftmost character in `sbus-probe-list` will be `f` (not 0) which is reserved for the CPU.

1. **Be sure a monitor is connected to the frame buffer identified as the console.**
2. **Reboot the system.**

Index

NUMERICS

24-bit TrueColor Linear Visual, 43
24-bit TrueColor Visual, 40, 45
8-bit PseudoColor, 40
8-bit StaticGray Linear Visual, 43
8R visual, 42
8X visual, 42

A

accelerated XIL functions, 54
afbconfig utility, 83
available frame buffers, 119

B

BadAlloc failure, 48

C

CDE, running on Creator Graphics Accelerator, 46
cgsix frame buffer, 18
changing the polling order, 122
checking available frame buffers, 119
color LUT, 43
colormap flashing, 45
colormap flashing, reducing, 40

Common Desktop Environment (CDE) on
PGX32, 79
configuring monitors using a UNIX script
(TurboGXplus Frame Buffer), 19
creating a device file name, 121
Creator Graphics Accelerator, 23 to 38
 cursor management, 48
 default screen resolutions, 24
 default visual, 46
 overlay/underlay structure, 42
 performance notes, 50
 stereo connector, 36
 visuals, 40 to 42
 window manager implications, 44
 window system, 39 to 52
 XIL acceleration on, 53 to 59
cursor management (Creator Graphics
Accelerator), 48

D

DBZ (Creator 3D), 39
default screen resolutions
 Creator Graphics Accelerator, 24
 Elite3D Graphics Accelerator, 84
 TurboGXplus Frame Buffer, 16
default visual, 40
 Creator Graphics Accelerator, 46
defdepth modes, 47
device file names, 119, 121

Direct Xlib, not supported on Creator Graphics Accelerator, 50
display molecules, 54
double buffer support on Creator, 57
double buffering, hardware, 49

E

Elite3D Graphics Accelerator
 default screen resolutions, 84
 stereo connector, 95
Expert3D Graphics Accelerator, 99 to 116
 configuration utilities, 99
 connectors, 111
 default screen resolutions, 100
 default visual, 105
 extended overlay, 108
 gamma correction, 107
 multiple monitors, 108
 OpenGL visual support, 106
 screen visuals list, 104
 supported screen resolutions, 101
 visual list order, 104

F

fbconfig utility, 99
FFB (Fast Frame Buffer), 40
ffbconfig utility, 23, 42, 49

G

gamma correction, 43
GFXconfig utility, 67 to 81

H

hardware cursor, 48
hardware double buffering, 49
hardware Window ID (WID), 47

I

ifbconfig utility, 100

L

linear visual, 28, 29, 43, 87, 88, 104

M

m640, built-in graphics device, 80
m64config utility, 61 to 65
maxwids, 42, 48
MBX hardware double buffering support, 49
MITSHM extension, 50
monitor ID sense code, 24, 84
monitors supported by TurboGXplus Frame Buffer, 15
multiple monitors, 117 to 124
 configuration, 117
 OpenWindows on, 121
 programming screen resolution on TurboGXplus Frame Buffer, 17

N

nonlinear visual, 28, 29, 87, 88, 104
non-Sun monitor
 on Creator Graphics Accelerator, 24
 on Elite3D Graphics Accelerator, 84
 on TurboGXplus Frame Buffer, 16
nvedit, using to modify NVRAM, 74, 80
NVRAM, modifying with nvedit, 74, 80
nvramrc, 17

O

opaque pixels, 47
OpenBoot PROM, 123
OpenWindows on multiple monitors, 121
overlay 8-bit PseudoColor visual, 42
overlay pixel codes, 47
OWconfig file, 23, 83

P

- PGX Graphics Accelerator, 61 to 65
 - supported screen resolutions, 62
 - video modes, 72
- PGX32 Graphics Accelerator, 67 to 81
 - as console, 77, 78
 - Common Desktop Environment (CDE) on, 79
 - configuration window, 68
 - screen resolutions, 72
 - video timing, 74
- polling order, changing, 122
- PROM method
 - configuring monitors (TurboGXplus Frame Buffer), 19
 - single monitor configuration (TurboGXplus Frame Buffer), 20

S

- SB (Creator), 39
- sbus-probe-list, 123
- screen resolutions
 - Creator and Creator3D Graphics Accelerator, 25
 - Elite3D Graphics Accelerator, 84
 - PGX Graphics Accelerator, 62
 - TurboGXplus Frame Buffer, 17
- setting up a single monitor using a UNIX script (TurboGXplus Frame Buffer), 21
- setting up a single monitor using the PROM method (TurboGXplus Frame Buffer), 20
- ShowMe Whiteboard snap region slow-down, 51
- stereo cable, 38, 97
- StereoGraphics Corporation, 38, 97, 113
- SunForum card, 79
- supported monitors
 - TurboGXplus Frame Buffer, 15

T

- TurboGXplus Frame Buffer, 15 to 21
 - default screen resolution, 16
 - screen resolutions, 17
 - supported monitors, 15

U

- UltraSPARC Visual Instruction Set (VIS), 53
- underlay 8-bit PseudoColor visual, 42
- UNIX script
 - for single monitor configuration (TurboGXplus Frame Buffer), 21
 - to configure monitors (TurboGXplus Frame Buffer), 19

V

- video modes, PGX32 Graphics Accelerator, 72
- video timing, PGX32 Graphics Accelerator, 74
- Visual Instruction Set (VIS), 53

W

- window system, Creator Graphics Accelerator, 39 to 52

X

- X display manager (xdm), 79
- X shared memory transport feature, 50
- x11perf benchmark, 51
- X-channel architecture, 42
- XGetVisualInfo, 43, 44
- XGL double buffering support, 49
- XGLNOPEX environment variable, 65
- XIL
 - accelerated functions, 54
 - acceleration on Creator Graphics Accelerator, 53 to 59
 - data types, 53
- XSolarisGetVisualGamma, 43
- XSolarisOvlSelectBestOverlay, 44

