

Sun™ StorEdge™ PCI FC-100 Host Adapter Installation Manual



THE NETWORK IS THE COMPUTER™

Sun Microsystems Computer Company

A Sun Microsystems, Inc. Business
901 San Antonio Road
Palo Alto, CA 94303-4900 USA
650 960-1300 fax 650 969-9131

Part No.: 805-3682-10
Revision A, February 1998

Send comments about this document to: smcc-docs@sun.com

Copyright 1998 Sun Microsystems, Inc. 901 San Antonio Road • Palo Alto, CA 94303 USA. All rights reserved.

This product or document is protected by copyright and distributed under licenses restricting its use, copying, distribution, and decompilation. No part of this product or document may be reproduced in any form by any means without prior written authorization of Sun and its licensors, if any. Third-party software, including font technology, is copyrighted and licensed from Sun suppliers.

Parts of the product may be derived from Berkeley BSD systems, licensed from the University of California. UNIX is a registered trademark in the U.S. and other countries, exclusively licensed through X/Open Company, Ltd.

Sun, Sun Microsystems, the Sun logo, AnswerBook, SunDocs, SunVTS, Sun Enterprise Network Array, StorEdge, and Solaris are trademarks, registered trademarks, or service marks of Sun Microsystems, Inc. in the U.S. and other countries. All SPARC trademarks are used under license and are trademarks or registered trademarks of SPARC International, Inc. in the U.S. and other countries. Products bearing SPARC trademarks are based upon an architecture developed by Sun Microsystems, Inc.

The OPEN LOOK and Sun™ Graphical User Interface was developed by Sun Microsystems, Inc. for its users and licensees. Sun acknowledges the pioneering efforts of Xerox in researching and developing the concept of visual or graphical user interfaces for the computer industry. Sun holds a non-exclusive license from Xerox to the Xerox Graphical User Interface, which license also covers Sun's licensees who implement OPEN LOOK GUIs and otherwise comply with Sun's written license agreements.

RESTRICTED RIGHTS: Use, duplication, or disclosure by the U.S. Government is subject to restrictions of FAR 52.227-14(g)(2)(6/87) and FAR 52.227-19(6/87), or DFAR 252.227-7015(b)(6/95) and DFAR 227.7202-3(a).

DOCUMENTATION IS PROVIDED "AS IS" AND ALL EXPRESS OR IMPLIED CONDITIONS, REPRESENTATIONS AND WARRANTIES, INCLUDING ANY IMPLIED WARRANTY OF MERCHANTABILITY, FITNESS FOR A PARTICULAR PURPOSE OR NON-INFRINGEMENT, ARE DISCLAIMED, EXCEPT TO THE EXTENT THAT SUCH DISCLAIMERS ARE HELD TO BE LEGALLY INVALID.

Copyright 1998 Sun Microsystems, Inc., 901 San Antonio Road • Palo Alto, CA 94303 Etatis-Unis. Tous droits réservés.

Ce produit ou document est protégé par un copyright et distribué avec des licences qui en restreignent l'utilisation, la copie, la distribution, et la décompilation. Aucune partie de ce produit ou document ne peut être reproduite sous aucune forme, par quelque moyen que ce soit, sans l'autorisation préalable et écrite de Sun et de ses bailleurs de licence, s'il y en a. Le logiciel détenu par des tiers, et qui comprend la technologie relative aux polices de caractères, est protégé par un copyright et licencié par des fournisseurs de Sun.

Des parties de ce produit pourront être dérivées des systèmes Berkeley BSD licenciés par l'Université de Californie. UNIX est une marque déposée aux Etats-Unis et dans d'autres pays et licenciée exclusivement par X/Open Company, Ltd.

Sun, Sun Microsystems, le logo Sun, AnswerBook, SunDocs, SunVTS, Sun Enterprise Network Array, StorEdge, et Solaris sont des marques de fabrique ou des marques déposées, ou marques de service, de Sun Microsystems, Inc. aux Etats-Unis et dans d'autres pays. Toutes les marques SPARC sont utilisées sous licence et sont des marques de fabrique ou des marques déposées de SPARC International, Inc. aux Etats-Unis et dans d'autres pays. Les produits portant les marques SPARC sont basés sur une architecture développée par Sun Microsystems, Inc.

L'interface d'utilisation graphique OPEN LOOK et Sun™ a été développée par Sun Microsystems, Inc. pour ses utilisateurs et licenciés. Sun reconnaît les efforts de pionniers de Xerox pour la recherche et le développement du concept des interfaces d'utilisation visuelle ou graphique pour l'industrie de l'informatique. Sun détient une licence non exclusive de Xerox sur l'interface d'utilisation graphique Xerox, cette licence couvrant également les licenciés de Sun qui mettent en place l'interface d'utilisation graphique OPEN LOOK et qui en outre se conforment aux licences écrites de Sun.

CETTE PUBLICATION EST FOURNIE "EN L'ETAT" ET AUCUNE GARANTIE, EXPRESSE OU IMPLICITE, N'EST ACCORDEE, Y COMPRIS DES GARANTIES CONCERNANT LA VALEUR MARCHANDE, L'APTITUDE DE LA PUBLICATION A REpondre A UNE UTILISATION PARTICULIERE, OU LE FAIT QU'ELLE NE SOIT PAS CONTREFAISANTE DE PRODUIT DE TIERS. CE DENI DE GARANTIE NE S'APPLIQUERAIT PAS, DANS LA MESURE OU IL SERAIT TENU JURIDIQUEMENT NUL ET NON AVENU.



Adobe PostScript

Regulatory Compliance Statements

Your Sun product is marked to indicate its compliance class:

- Federal Communications Commission (FCC) — USA
- Department of Communications (DOC) — Canada
- Voluntary Control Council for Interference (VCCI) — Japan

Please read the appropriate section that corresponds to the marking on your Sun product before attempting to install the product.

FCC Class A Notice

This device complies with Part 15 of the FCC Rules. Operation is subject to the following two conditions:

1. This device may not cause harmful interference.
2. This device must accept any interference received, including interference that may cause undesired operation.

Note: This equipment has been tested and found to comply with the limits for a Class A digital device, pursuant to Part 15 of the FCC Rules. These limits are designed to provide reasonable protection against harmful interference when the equipment is operated in a commercial environment. This equipment generates, uses and can radiate radio frequency energy and, if not installed and used in accordance with the instruction manual, may cause harmful interference to radio communications. Operation of this equipment in a residential area is likely to cause harmful interference in which case the user will be required to correct the interference at his own expense.

Shielded Cables: Connections between the workstation and peripherals must be made using shielded cables in order to maintain compliance with FCC radio frequency emission limits. Networking connections can be made using unshielded twisted-pair (UTP) cables.

Modifications: Any modifications made to this device that are not approved by Sun Microsystems, Inc. may void the authority granted to the user by the FCC to operate this equipment.

FCC Class B Notice

This device complies with Part 15 of the FCC Rules. Operation is subject to the following two conditions:

1. This device may not cause harmful interference.
2. This device must accept any interference received, including interference that may cause undesired operation.

Note: This equipment has been tested and found to comply with the limits for a Class B digital device, pursuant to Part 15 of the FCC Rules. These limits are designed to provide reasonable protection against harmful interference in a residential installation. This equipment generates, uses and can radiate radio frequency energy and, if not installed and used in accordance with the instructions, may cause harmful interference to radio communications. However, there is no guarantee that interference will not occur in a particular installation. If this equipment does cause harmful interference to radio or television reception, which can be determined by turning the equipment off and on, the user is encouraged to try to correct the interference by one or more of the following measures:

- Reorient or relocate the receiving antenna.
- Increase the separation between the equipment and receiver.
- Connect the equipment into an outlet on a circuit different from that to which the receiver is connected.
- Consult the dealer or an experienced radio/television technician for help.

Shielded Cables: Connections between the workstation and peripherals must be made using shielded cables in order to maintain compliance with FCC radio frequency emission limits. Networking connections can be made using unshielded twisted pair (UTP) cables.

Modifications: Any modifications made to this device that are not approved by Sun Microsystems, Inc. may void the authority granted to the user by the FCC to operate this equipment.

DOC Class A Notice - Avis DOC, Classe A

This Class A digital apparatus meets all requirements of the Canadian Interference-Causing Equipment Regulations.
Cet appareil numérique de la classe A respecte toutes les exigences du Règlement sur le matériel brouilleur du Canada.

DOC Class B Notice - Avis DOC, Classe B

This Class B digital apparatus meets all requirements of the Canadian Interference-Causing Equipment Regulations.
Cet appareil numérique de la classe B respecte toutes les exigences du Règlement sur le matériel brouilleur du Canada.

VCCI 基準について

第一種 VCCI 基準について

第一種VCCIの表示があるワークステーションおよびオプション製品は、第一種情報装置です。これらの製品には、下記の項目が該当します。

この装置は、第一種情報装置(商工業地域において使用されるべき情報装置)で商工業地域での電波障害防止を目的とした情報処理装置等電波障害自主規制協議会(VCCI)基準に適合しております。したがって、本製品を、住宅地域または住宅地域に隣接した地域でご使用になりますと、ラジオ、テレビジョン受信機等に受信障害を与えることがあります。

取り扱い説明書に従って正しくお取り扱いください。

第二種 VCCI 基準について

第二種VCCIの表示  があるワークステーションおよびオプション製品は、第二種情報装置です。これらの製品には、下記の項目が該当します。

この装置は、第二種情報装置(住宅地域または住宅地域に隣接した地域において使用されるべき情報装置)で住宅地域での電波障害防止を目的とした情報処理装置等電波障害自主規制協議会(VCCI)基準に適合しております。しかし、本製品を、ラジオ、テレビジョン受信機に近接してご使用になりますと、受信障害の原因となることがあります。

取り扱い説明書に従って正しくお取り扱いください。

Safety Agency Compliance Statements

Read this section before beginning any procedure. The following text provides safety precautions to follow when installing a Sun Microsystems product.

Safety Precautions

For your protection, observe the following safety precautions when setting up your equipment:

- Follow all cautions and instructions marked on the equipment.
- Ensure that the voltage and frequency of your power source match the voltage and frequency inscribed on the equipment's electrical rating label.
- Never push objects of any kind through openings in the equipment. Dangerous voltages may be present. Conductive foreign objects could produce a short circuit that could cause fire, electric shock, or damage to your equipment.

Symbols

The following symbols may appear in this book:



Caution – There is risk of personal injury and equipment damage. Follow the instructions.



Caution – Hot surface. Avoid contact. Surfaces are hot and may cause personal injury if touched.



Caution – Hazardous voltages are present. To reduce the risk of electric shock and danger to personal health, follow the instructions.



On – Applies AC power to the system.

Depending on the type of power switch your device has, one of the following symbols may be used:



Off – Removes AC power from the system.



Standby – The On/Standby switch is in the *standby* position.

Modifications to Equipment

Do not make mechanical or electrical modifications to the equipment. Sun Microsystems is not responsible for regulatory compliance of a modified Sun product.

Placement of a Sun Product



Caution – Do not block or cover the openings of your Sun product. Never place a Sun product near a radiator or heat register. Failure to follow these guidelines can cause overheating and affect the reliability of your Sun product.

SELV Compliance

Safety status of I/O connections comply to SELV requirements.

Power Cord Connection



Caution – Sun products are designed to work with single-phase power systems having a grounded neutral conductor. To reduce the risk of electric shock, do not plug Sun products into any other type of power system. Contact your facilities manager or a qualified electrician if you are not sure what type of power is supplied to your building.



Caution – Not all power cords have the same current ratings. Household extension cords do not have overload protection and are not meant for use with computer systems. Do not use household extension cords with your Sun product.



Caution – Your Sun product is shipped with a grounding type (three-wire) power cord. To reduce the risk of electric shock, always plug the cord into a grounded power outlet.

The following caution applies only to devices with a **Standby** power switch:



Caution – The power switch of this product functions as a standby type device only. The power cord serves as the primary disconnect device for the system. Be sure to plug the power cord into a grounded power outlet that is nearby the system and is readily accessible. Do not connect the power cord when the power supply has been removed from the system chassis.

System Unit Cover

You must remove the cover of your Sun computer system unit in order to add cards, memory, or internal storage devices. Be sure to replace the top cover before powering up your computer system.



Caution – Do not operate Sun products without the top cover in place. Failure to take this precaution may result in personal injury and system damage.

Laser Compliance Notice

Sun products that use laser technology comply with Class 1 laser requirements.

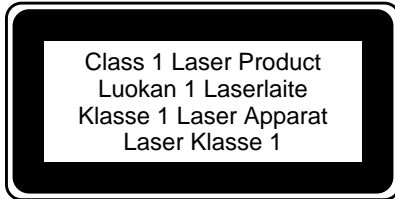

Einhaltung sicherheitsbehördlicher Vorschriften

Auf dieser Seite werden Sicherheitsrichtlinien beschrieben, die bei der Installation von Sun-Produkten zu beachten sind.

Sicherheitsvorkehrungen

Treffen Sie zu Ihrem eigenen Schutz die folgenden Sicherheitsvorkehrungen, wenn Sie Ihr Gerät installieren:

- Beachten Sie alle auf den Geräten angebrachten Warnhinweise und Anweisungen.
- Vergewissern Sie sich, daß Spannung und Frequenz Ihrer Stromquelle mit der Spannung und Frequenz übereinstimmen, die auf dem Etikett mit den elektrischen Nennwerten des Geräts angegeben sind.
- Stecken Sie auf keinen Fall irgendwelche Gegenstände in Öffnungen in den Geräten. Leitfähige Gegenstände könnten aufgrund der möglicherweise vorliegenden gefährlichen Spannungen einen Kurzschluß verursachen, der einen Brand, Stromschlag oder Geräteschaden herbeiführen kann.

Symbole

Die Symbole in diesem Handbuch haben folgende Bedeutung:



Achtung – Gefahr von Verletzung und Geräteschaden. Befolgen Sie die Anweisungen.



Achtung – Hohe Temperatur. Nicht berühren, da Verletzungsgefahr durch heiße Oberfläche besteht.



Achtung – Gefährliche Spannungen. Anweisungen befolgen, um Stromschläge und Verletzungen zu vermeiden.

Ein – Setzt das System unter Wechselstrom.

Je nach Netzschaltertyp an Ihrem Gerät kann eines der folgenden Symbole benutzt werden:



Aus – Unterbricht die Wechselstromzufuhr zum Gerät.



Wartezustand (Stand-by-Position) - Der Ein-/Wartezustand-Schalter steht auf Wartezustand. Änderungen an Sun-Geräten.

Nehmen Sie keine mechanischen oder elektrischen Änderungen an den Geräten vor. Sun Microsystems, übernimmt bei einem Sun-Produkt, das geändert wurde, keine Verantwortung für die Einhaltung behördlicher Vorschriften

Aufstellung von Sun-Geräten



Achtung – Um den zuverlässigen Betrieb Ihres Sun-Geräts zu gewährleisten und es vor Überhitzung zu schützen, dürfen die Öffnungen im Gerät nicht blockiert oder verdeckt werden. Sun-Produkte sollten niemals in der Nähe von Heizkörpern oder Heizluftklappen aufgestellt werden.

Einhaltung der SELV-Richtlinien

Die Sicherung der I/O-Verbindungen entspricht den Anforderungen der SELV-Spezifikation.

Anschluß des Netzkabels



Achtung – Sun-Produkte sind für den Betrieb an Einphasen-Stromnetzen mit geerdetem Nulleiter vorgesehen. Um die Stromschlaggefahr zu reduzieren, schließen Sie Sun-Produkte nicht an andere Stromquellen an. Ihr Betriebsleiter oder ein qualifizierter Elektriker kann Ihnen die Daten zur Stromversorgung in Ihrem Gebäude geben.



Achtung – Nicht alle Netzkabel haben die gleichen Nennwerte. Herkömmliche, im Haushalt verwendete Verlängerungskabel besitzen keinen Überlastungsschutz und sind daher für Computersysteme nicht geeignet.



Achtung – Ihr Sun-Gerät wird mit einem dreidadrigen Netzkabel für geerdete Netzsteckdosen geliefert. Um die Gefahr eines Stromschlags zu reduzieren, schließen Sie das Kabel nur an eine fachgerecht verlegte, geerdete Steckdose an.

Die folgende Warnung gilt nur für Geräte mit Wartezustand-Netzschalter:



Achtung – Der Ein/Aus-Schalter dieses Geräts schaltet nur auf Wartezustand (Stand-By-Modus). Um die Stromzufuhr zum Gerät vollständig zu unterbrechen, müssen Sie das Netzkabel von der Steckdose abziehen. Schließen Sie den Stecker des Netzkabels an eine in der Nähe befindliche, frei zugängliche, geerdete Netzsteckdose an. Schließen Sie das Netzkabel nicht an, wenn das Netzteil aus der Systemeinheit entfernt wurde.

Gehäuseabdeckung

Sie müssen die obere Abdeckung Ihres Sun-Systems entfernen, um interne Komponenten wie Karten, Speicherchips oder Massenspeicher hinzuzufügen. Bringen Sie die obere Gehäuseabdeckung wieder an, bevor Sie Ihr System einschalten.



Achtung – Bei Betrieb des Systems ohne obere Abdeckung besteht die Gefahr von Stromschlag und Systemschäden.

Einhaltung der Richtlinien für Laser

Sun-Produkte, die mit Laser-Technologie arbeiten, entsprechen den Anforderungen der Laser Klasse 1.

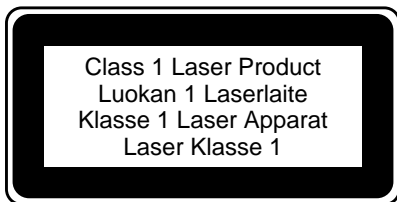

Conformité aux normes de sécurité

Ce texte traite des mesures de sécurité qu'il convient de prendre pour l'installation d'un produit Sun Microsystems.

Mesures de sécurité

Pour votre protection, veuillez prendre les précautions suivantes pendant l'installation du matériel :

- Suivre tous les avertissements et toutes les instructions inscrites sur le matériel.
- Vérifier que la tension et la fréquence de la source d'alimentation électrique correspondent à la tension et à la fréquence indiquées sur l'étiquette de classification de l'appareil.

- Ne jamais introduire d'objets quels qu'ils soient dans une des ouvertures de l'appareil. Vous pourriez vous trouver en présence de hautes tensions dangereuses. Tout objet conducteur introduit de la sorte pourrait produire un court-circuit qui entraînerait des flammes, des risques d'électrocution ou des dégâts matériels.

Symboles

Vous trouverez ci-dessous la signification des différents symboles utilisés :



Attention : risques de blessures corporelles et de dégâts matériels. Veuillez suivre les instructions.



Attention : surface à température élevée. Evitez le contact. La température des surfaces est élevée et leur contact peut provoquer des blessures corporelles.



Attention : présence de tensions dangereuses. Pour éviter les risques d'électrocution et de danger pour la santé physique, veuillez suivre les instructions.



MARCHE – Votre système est sous tension (courant alternatif).

Un des symboles suivants sera peut-être utilisé en fonction du type d'interrupteur de votre système:



ARRET – Votre système est hors tension (courant alternatif).



VEILLEUSE – L'interrupteur Marche/Veilleuse est en position « Veilleuse ».

Modification du matériel

Ne pas apporter de modification mécanique ou électrique au matériel. Sun Microsystems n'est pas responsable de la conformité réglementaire d'un produit Sun qui a été modifié.

Positionnement d'un produit Sun



Attention : pour assurer le bon fonctionnement de votre produit Sun et pour l'empêcher de surchauffer, il convient de ne pas obstruer ni recouvrir les ouvertures prévues dans l'appareil. Un produit Sun ne doit jamais être placé à proximité d'un radiateur ou d'une source de chaleur.

Conformité SELV

Sécurité : les raccordements E/S sont conformes aux normes SELV.

Connexion du cordon d'alimentation



Attention : les produits Sun sont conçus pour fonctionner avec des alimentations monophasées munies d'un conducteur neutre mis à la terre. Pour écarter les risques d'électrocution, ne pas brancher de produit Sun dans un autre type d'alimentation secteur. En cas de doute quant au type d'alimentation électrique du local, veuillez vous adresser au directeur de l'exploitation ou à un électricien qualifié.



Attention : tous les cordons d'alimentation n'ont pas forcément la même puissance nominale en matière de courant. Les rallonges d'usage domestique n'offrent pas de protection contre les surcharges et ne sont pas prévues pour les systèmes d'ordinateurs. Ne pas utiliser de rallonge d'usage domestique avec votre produit Sun.



Attention : votre produit Sun a été livré équipé d'un cordon d'alimentation à trois fils (avec prise de terre). Pour écarter tout risque d'électrocution, branchez toujours ce cordon dans une prise mise à la terre.

L'avertissement suivant s'applique uniquement aux systèmes équipés d'un interrupteur VEILLEUSE:



Attention : le commutateur d'alimentation de ce produit fonctionne comme un dispositif de mise en veille uniquement. C'est la prise d'alimentation qui sert à mettre le produit hors tension. Veuillez donc à installer le produit à proximité d'une prise murale facilement accessible. Ne connectez pas la prise d'alimentation lorsque le châssis du système n'est plus alimenté.

Couvercle

Pour ajouter des cartes, de la mémoire, ou des unités de stockage internes, vous devrez démonter le couvercle de l'unité système Sun. Ne pas oublier de remettre ce couvercle en place avant de mettre le système sous tension.



Attention : il est dangereux de faire fonctionner un produit Sun sans le couvercle en place. Si l'on néglige cette précaution, on encourt des risques de blessures corporelles et de dégâts matériels.

Conformité aux certifications Laser

Les produits Sun qui font appel aux technologies lasers sont conformes aux normes de la classe 1 en la matière.

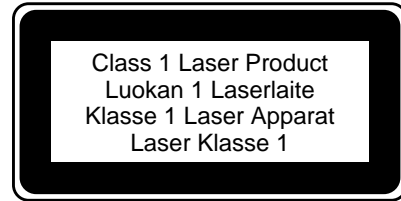

Normativas de seguridad

El siguiente texto incluye las medidas de seguridad que se deben seguir cuando se instale algún producto de Sun Microsystems.

Precauciones de seguridad

Para su protección observe las siguientes medidas de seguridad cuando manipule su equipo:

- Siga todas los avisos e instrucciones marcados en el equipo.
- Asegúrese de que el voltaje y la frecuencia de la red eléctrica concuerdan con las descritas en las etiquetas de especificaciones eléctricas del equipo.
- No introduzca nunca objetos de ningún tipo a través de los orificios del equipo. Pueden haber voltajes peligrosos. Los objetos extraños conductores de la electricidad pueden producir cortocircuitos que provoquen un incendio, descargas eléctricas o daños en el equipo.

Símbolos

En este libro aparecen los siguientes símbolos:



Precaución – Existe el riesgo de lesiones personales y daños al equipo. Siga las instrucciones.



Precaución – Superficie caliente. Evite el contacto. Las superficies están calientes y pueden causar daños personales si se tocan.



Precaución – Voltaje peligroso presente. Para reducir el riesgo de descarga y daños para la salud siga las instrucciones.



Encendido – Aplica la alimentación de CA al sistema.

Según el tipo de interruptor de encendido que su equipo tenga, es posible que se utilice uno de los siguientes símbolos:



Apagado – Elimina la alimentación de CA del sistema.



En espera – El interruptor de Encendido/En espera se ha colocado en la posición de *En espera*.

Modificaciones en el equipo

No realice modificaciones de tipo mecánico o eléctrico en el equipo. Sun Microsystems no se hace responsable del cumplimiento de las normativas de seguridad en los equipos Sun modificados.

Ubicación de un producto Sun



Precaución – Para asegurar la fiabilidad de funcionamiento de su producto Sun y para protegerlo de sobrecalentamientos no deben obstruirse o taparse las rejillas del equipo. Los productos Sun nunca deben situarse cerca de radiadores o de fuentes de calor.

Cumplimiento de la normativa SELV

El estado de la seguridad de las conexiones de entrada/salida cumple los requisitos de la normativa SELV.

Conexión del cable de alimentación eléctrica



Precaución – Los productos Sun están diseñados para trabajar en una red eléctrica monofásica con toma de tierra. Para reducir el riesgo de descarga eléctrica, no conecte los productos Sun a otro tipo de sistema de alimentación eléctrica. Póngase en contacto con el responsable de mantenimiento o con un electricista cualificado si no está seguro del sistema de alimentación eléctrica del que se dispone en su edificio.



Precaución – No todos los cables de alimentación eléctrica tienen la misma capacidad. Los cables de tipo doméstico no están provistos de protecciones contra sobrecargas y por tanto no son apropiados para su uso con computadores. No utilice alargadores de tipo doméstico para conectar sus productos Sun.



Precaución – Con el producto Sun se proporciona un cable de alimentación con toma de tierra. Para reducir el riesgo de descargas eléctricas conéctelo siempre a un enchufe con toma de tierra.

La siguiente advertencia se aplica solamente a equipos con un interruptor de encendido que tenga una posición "En espera":



Precaución – El interruptor de encendido de este producto funciona exclusivamente como un dispositivo de puesta en espera. El enchufe de la fuente de alimentación está diseñado para ser el elemento primario de desconexión del equipo. El equipo debe instalarse cerca del enchufe de forma que este último pueda ser fácil y rápidamente accesible. No conecte el cable de alimentación cuando se ha retirado la fuente de alimentación del chasis del sistema.

Tapa de la unidad del sistema

Debe quitar la tapa del sistema cuando sea necesario añadir tarjetas, memoria o dispositivos de almacenamiento internos. Asegúrese de cerrar la tapa superior antes de volver a encender el equipo.



Precaución – Es peligroso hacer funcionar los productos Sun sin la tapa superior colocada. El hecho de no tener en cuenta esta precaución puede ocasionar daños personales o perjudicar el funcionamiento del equipo.

Aviso de cumplimiento con requisitos de láser

Los productos Sun que utilizan la tecnología de láser cumplen con los requisitos de láser de Clase 1.

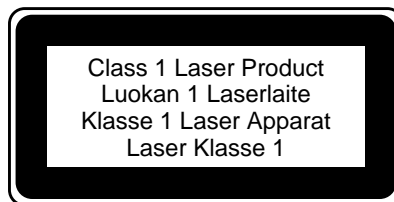

Declaration of Conformity

Marketing Part Numbers: 6729A, X6729A

Product Name: Sun StorEdge PCI FC-100 Host Adapter

This product has been tested and complies with:

EMC

USA—FCC Class B

This device complies with Part 15 of the FCC Rules. Operation is subject to the following two conditions:

1. This device may not cause harmful interference.
2. This device must accept any interference received, including interference that may cause undesired operation.

European Union-EC

This equipment complies with the following requirements of the EMC Directive 89/336/EEC

EN55022 / CISPR22 (1985)		Class B
EN50082-1	IEC801-2 (1991)	4 kV (Direct), 8 kV (Air)
	IEC801-3 (1984)	3 V/m
	IEC801-4 (1988)	1.0 kV Power Lines, 0.5 kV Signal Lines

Supplementary Information

This product was tested and complies with all the requirements for the CE Mark.

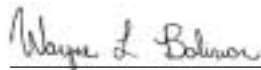

6 Feb 1998

Wayne L. Bolivar
Manager, Qualification Engineering

Sun Microsystems Computer Company
4 Omni Way UCHL04-203
Chelmsford, MA 01824 USA
Tel: (978) 442-0599
Fax: (978) 250-5059

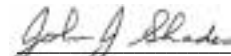

6 Feb 1998

John Shades
Quality Assurance Manager

Sun Microsystems Limited
Springfield, Linlithgow
West Lothian, EH49 7LR
Scotland, United Kingdom
Tel: 1506 670000
Fax: 1506 672323

Contents

Preface xv

1. Installation 1-1

1.1 Tools and Equipment Needed 1-1

1.2 Preparing for Installation 1-2

1.3 Installing the Host Adapter 1-5

1.4 Testing the Installation With SunVTS 1-8

A. Specifications A-1

A.1 PCI Card A-1

A.2 Fibre Channel Interface Specifications A-1

A.3 Performance Specifications A-2

A.4 Power Requirements A-2

A.5 Physical Dimensions A-3

A.6 Regulatory Compliance A-3

A.7 PCI Edge Connector Pin Definitions A-4

Preface

The *Sun StorEdge PCI FC-100 Host Adapter Installation Manual* describes how to install Sun™ StorEdge™ PCI FC-AL 33-MHz, 100 Mbytes/sec Host Adapters. These instructions are designed for an experienced system administrator or trained service provider.

Using UNIX Commands

This document does not contain information on basic UNIX® commands and procedures such as shutting down the system, booting the system, and configuring devices.

See one or more of the following for this information:

- *Solaris 2.x Handbook for SMCC Peripherals*
- AnswerBook™ online documentation for the Solaris™ 2.x software environment
- Other software documentation that you received with your system

Typographic Conventions

TABLE P-1 Typographic Conventions

Typeface or Symbol	Meaning	Examples
AaBbCc123	The names of commands, files, and directories; on-screen computer output.	Edit your <code>.login</code> file. Use <code>ls -a</code> to list all files. % You have mail.
AaBbCc123	What you type, when contrasted with on-screen computer output.	% su Password:
<i>AaBbCc123</i>	Book titles, new words or terms, words to be emphasized. Command-line variable; replace with a real name or value.	Read Chapter 6 in the <i>User's Guide</i> . These are called <i>class</i> options. You <i>must</i> be <code>root</code> to do this. To delete a file, type <code>rm filename</code> .

Shell Prompts

TABLE P-2 Shell Prompts

Shell	Prompt
C shell	<i>machine_name%</i>
C shell superuser	<i>machine_name#</i>
Bourne shell and Korn shell	\$
Bourne shell and Korn shell superuser	#

Related Documentation

Refer to the *Sun StorEdge A5000 Installation Tasks and Documentation Guide*, Part Number 805-1903, for a list of related documentation

Ordering Sun Documents

SunDocsSM is a distribution program for Sun Microsystems technical documentation. Contact SunExpress for easy ordering and quick delivery. You can find a listing of available Sun documentation on the World Wide Web.

TABLE P-3 SunExpress Contact Information

Country	Telephone	Fax
Belgium	02-720-09-09	02-725-88-50
Canada	1-800-873-7869	1-800-944-0661
France	0800-90-61-57	0800-90-61-58
Germany	01-30-81-61-91	01-30-81-61-92
Holland	06-022-34-45	06-022-34-46
Japan	0120-33-9096	0120-33-9097
Luxembourg	32-2-720-09-09	32-2-725-88-50
Sweden	020-79-57-26	020-79-57-27
Switzerland	0800-55-19-26	0800-55-19-27
United Kingdom	0800-89-88-88	0800-89-88-87
United States	1-800-873-7869	1-800-944-0661

World Wide Web: <http://www.sun.com/sunexpress/>

Sun Documentation on the Web

The `docs.sun.com` web site enables you to access Sun technical documentation on the World Wide Web. You can browse the `docs.sun.com` archive or search for a specific book title or subject at `http://docs.sun.com`.

Sun Welcomes Your Comments

We are interested in improving our documentation and welcome your comments and suggestions. You can email your comments to us at `smcc-docs@sun.com`. Please include the part number of your document in the subject line of your email.

Installation

This chapter describes how to install the Sun StorEdge PCI FC-100 Host Adapter in a system.

1.1 Tools and Equipment Needed

You may need to order fiber optic cables. You can order them in the following lengths:

- 2-meter, part number X973A
- 15-meter, part number X978A

You will also need:

- A No. 2 Phillips screwdriver
- An antistatic wrist strap
- A padded antistatic mat

1.2 Preparing for Installation

1. For installation with a Sun StorEdge A5000 array, use the array's front panel module (FPM) to ensure that the firmware level of the interface boards is at least 1.05.

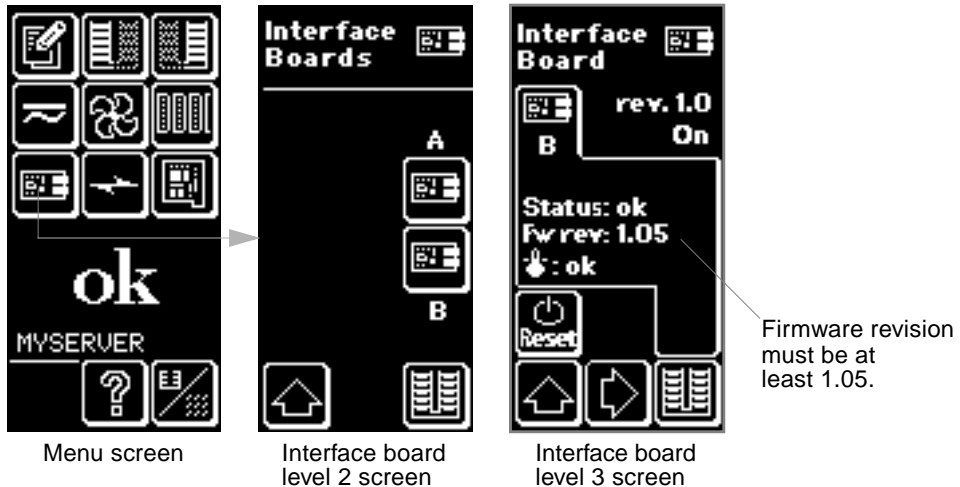

FIGURE 1-1 Checking the A5000 Array Interface Board Firmware Level

If the firmware level is less than 1.05, you must upgrade the firmware using an SBus-based host system before you can connect the array to the Sun StorEdge PCI FC-100 Host Adapter. The instructions for obtaining the upgrade patch are in Step 3.

2. Determine which version of the operating system you are running.

Look at the `/etc/release` file and make sure the operating system installed is at least Solaris 2.6. If you don't have an `/etc/release` file, you probably need to upgrade your operating system to at least Solaris 2.6.

3. Get the required patches, if any.

a. Go to the <http://docs.sun.com> web site.

b. Go to the Storage & Peripherals section and read the *Sun StorEdge A5000 Installation Supplement*.

c. Download the patches from:

<http://sunsolve.sun.com/sunsolve/pubpatches/patches.html>

Contact your support service provider if you cannot access these web sites.

Note – Be sure to read and follow the directions in the README file for each patch.

4. Log in as `root` on your system.

5. Verify that the `SUNWses`, `SUNWssadv`, and `SUNWvts` packages have been installed on your system.

Use the `/usr/bin/pkginfo` command and `grep` for each of the above patches. For example:

```
# /usr/bin/pkginfo | grep SUNWvts
system          SUNWvts          Online Validation Test Suite
```

If you are missing any of these patches, you can get them from the *Updates for Solaris Operating Environment 2.6* CD-ROM.

6. Insert the CD-ROM that was shipped with the host adapter.

- If the CD-ROM is mounted automatically, go to Step 7.
- If the CD-ROM is not mounted automatically, type:

```
# mount -F hsfs -r /dev/dsk/c0t6d0s2 /cdrom
```

7. Change to the following directory:

```
# cd /cdrom/sun_pci_fc100_1_0/Product
```

8. Install all the packages on the CD-ROM:

```
# pkgadd -d .
```

This command is interactive. Answer the questions when you are prompted to do so. For example:

```
The following packages are available:
 1  SUNWifp      Sun Fibre Channel Arbitrated Loop Device Driver
      (sparc) 11.6,REV=1998.02.05.16.47
 2  SUNWifph    Sun Fibre Channel Arbitrated Loop Driver Header Files
      (sparc) 11.6,REV=1998.02.05.16.47
 3  SUNWvtsfp   SunVTS IFP Controller Test
      (sparc) 2.1.2,REV=12.98.01.30

Select package(s) you wish to process (or 'all' to process
all packages). (default: all) [?,??,q]:
```

9. Exit the operating environment.

To inform any mounted users that the system will be going down, use the `shutdown` command. Otherwise, use the `init 0` command. See the man pages for these commands or the Solaris AnswerBook online documentation.

10. Power off the system.

Refer to the service documentation that came with your system.



Caution – Do not disconnect the power cord at this time. This connection provides the ground path necessary to remove and install printed circuit boards and components without damage.

11. Choose a slot into which to install the host adapter.

Follow the procedures in the documentation supplied with your system.

For systems that have more than one system board, you must also select and remove a system board that has an available PCI slot. Refer to your system documentation for specific instructions.

12. **Attach the antistatic wrist strap to your wrist and to a metal component on the system chassis.**

The wrist strap between you and the chassis provides the ground path necessary to safely remove and install the printed circuit boards and components without damaging them.

13. **For systems with a standby-type power switch, disconnect the power cord.**

Standby-type power switches have a  icon.

14. **Open the system.**

Refer to your system documentation for specific instructions.



Caution – If you need to remove a system board for the installation, place the board on a padded antistatic mat to prevent breakage.

1.3 Installing the Host Adapter

1. **Pull the two dust covers out of the gigabit interface converter (GBIC) connectors (FIGURE 1-2).**

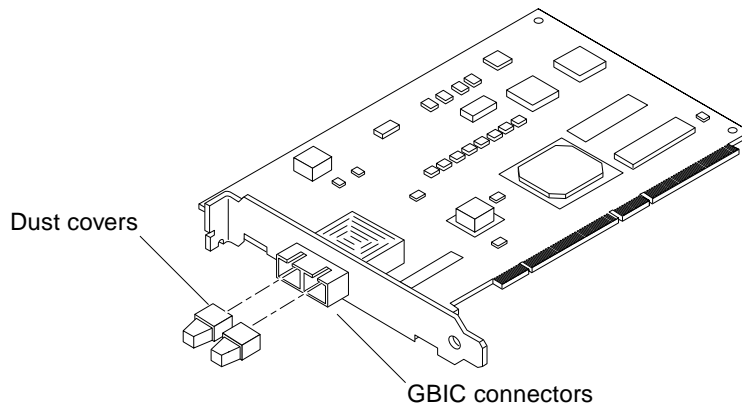

FIGURE 1-2 Sun StorEdge PCI FC-100 Host Adapter

2. **Install the host adapter in the PCI slot you have chosen.**

Installation details vary for each system. Refer to your system documentation for specific instructions.

3. Reassemble the system.

Refer to your system documentation for specific instructions.

4. Disconnect the wrist strap.

5. Push the fiber optic cable connector into the GBIC until you hear a click

(FIGURE 1-3).



Caution – Fiber optic cables have keyed connectors; they can only be inserted into GBICs as shown in FIGURE 1-3.

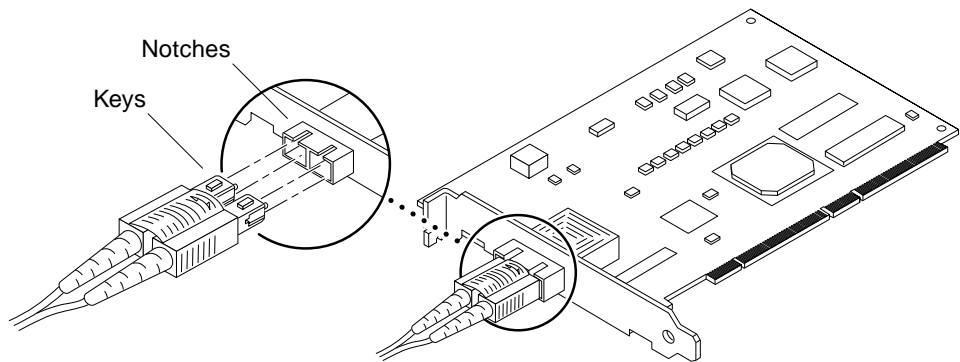

FIGURE 1-3 Connecting a Fiber Optic Cable to a GBIC

6. Connect the other end of the fiber optic cable to a device such as a disk array or hub.

Refer to the *Sun StorEdge A5000 Hardware Configuration Guide*, part number 805-0264, and the documentation that came with the device for specific instructions.

7. Power on your peripherals and then your system.

Note – If your system starts to reboot, interrupt the reboot process by pressing the Stop-A keys.

The system should now be at the `ok` prompt. If a `>` prompt is showing, type `n` to switch to the `ok` prompt.

8. Make sure that the host adapter is recognized by the system.

Use the `show-devs` command to locate the host adapter directory and the `show-children` command to display the FC-AL devices connected to your system. For example:

```
ok show-devs
/pci@6,2000
/pci@6,4000
/pci@4,2000
/pci@4,4000
/SUNW,ffb@1d,0
/SUNW,UltraSPARC-II@0,0
/mc@0,0
/pci@1f,2000
/pci@1f,4000
/counter-timer@1f,1c00
/associations
/virtual-memory
/memory@0,0
/aliases
/options
/openprom
/chosen
/packages
/pci@4,4000/SUNW,ifp@4
/pci@4,4000/SUNW,ifp@4/ssd
...
ok select select /pci@4,4000/SUNW,ifp@4
ok show-children
LiD  HA  --- Port WWN  ---  --- Disk description  ---
1d  1d  5080020000007c22  SUN   SENA           1.05P|
10  10  21000020370710ac  SEAGATE ST19171FCSUN9.0G10789735C05778
11  11  2100002037076b25  SEAGATE ST19171FCSUN9.0G10789735H45113
12  12  2100002037072a4f  SEAGATE ST19171FCSUN9.0G10789735D25090
13  13  21000020370729fe  SEAGATE ST19171FCSUN9.0G10789735C59513
14  14  21000020370751a1  SEAGATE ST19171FCSUN9.0G10789735E83001
15  15  2100002037075299  SEAGATE ST19171FCSUN9.0G10789735E83803
16  16  2100002037075302  SEAGATE ST19171FCSUN9.0G10789735E83720
...
```

In the example, `pci@4,4000/SUNW,ifp@4` is the Sun StorEdge PCI FC-100 Host Adapter and the disks shown by using the `show-children` command are in a Sun StorEdge A5000 array (SENA).

9. Reboot your system using the `boot -r` command.

1.4 Testing the Installation With SunVTS

SunVTS™ is a diagnostic program that exercises your system to verify the functionality, reliability, and configuration of your host adapter card. Run the SunVTS program if you are having problems accessing the host adapter or attached disks..

This section provides a brief set of instructions for running the SunVTS program. For more details, refer to the *SunVTS 2.X User's Guide*.

1. **Log in as root on your system.**
2. **Bring up the SunVTS window.**

```
# /opt/SUNWvts/bin/sunvts
```

3. **Select a disk drive that is attached to the host adapter card you just installed.**
4. **Start the test.**
5. **Verify that no errors have occurred by checking the SunVTS status window.**
6. **If no problems occur, stop SunVTS.**

Your host adapter card is ready to run applications.

Specifications

A.1 PCI Card

The Sun StorEdge PCI FC-100 Host Adapter is a single-loop Fibre Channel PCI card with an onboard gigabit interface converter (GBIC). This host adapter is PCI Version 2.1 compliant.

A.2 Fibre Channel Interface Specifications

TABLE A-1 Fibre Channel Interface Specifications

Specification	Value
ANSI Standards	Fibre Channel FC-PH X3.230-1995 SCSI Fibre Channel Protocol X3.269-1996
GBIC	100 MBytes/sec (1 Gbits/sec) full duplex Shortwave laser, Module Definition 5
Fiber cable type	50 micrometer multimode
Maximum cable length	500 meters

A.3 Performance Specifications

TABLE A-2 Performance Specifications

Feature	Specification
PCI clock	66 MHz max.
PCI data burst transfer rate	528 MBytes/sec burst rate
FC-AL transfer rate payload	100 Mbytes/sec
DMA transfer size 32-bit	4 Gbyte max.
PCI data/address lines	AD63-0
PCI modes	Master/slave
Capacitance per PCI signal line	≤ 10 pF, except for CLK between 5 to 12 pF and IDSEL ≤ 8pF
FC-AL Interface	1 Gbit optical (1.026 bits/sec)

A.4 Power Requirements

TABLE A-3 Power Requirements

Specification	Rating
Power Requirements	
5V ±5%	3A
3.3V ±9%	130 mA
Ripple	100 mV

A.5 Physical Dimensions

TABLE A-4 Physical Dimensions

Height	Width	Depth	Weight
.6 inches	4.2 inches	6.875 inches	3.6 oz
15 mm	106.68 mm	174.63 mm	109g

A.6 Regulatory Compliance

TABLE A-5 Requirements Met or Exceeded by the Host Adapter

Category	Rating
Safety	UL 1950
	CSA 950
	TUV EN 60950
	Class 1 laser requirements per CFR 21, Part 1040 and IEC 825
RFI/EMI	FCC Class B
	DOC Class B
	VCCI Class 1
	EMC Directive (89/336/EEC), EN55022
Immunity	EMC Directive (89/336/EEC), EN55082-1

A.7 PCI Edge Connector Pin Definitions

TABLE A-6 PCI Edge Connector Pin Definitions (Top)

Pin	Description	Pin	Description	Pin	Description	Pin	Description
1	-12V	25	+3.3V	49	GND	73	Ground
2	TCK	26	C_BE3	50	KEYWAY	74	AD[55]
3	GND	27	AD23	51	KEYWAY	75	AD[53]
4	TDO	28	GND	52	AD08	76	Ground
5	+5V	29	AD21	53	AD07	77	AD[51]
6	+5V	30	AD19	54	+3.3V	78	AD[49]
7	INTB	31	+3.3V	55	AD05	79	+5V
8	INTD	32	AD17	56	AD03	80	AD[45]
9	GND (PRSNT1)	33	C_BE2	57	GND	81	AD[47]
10	RESERVED	34	GND	58	AD01	82	Ground
11	GND (PRSNT2)	35	IRDY	59	5V	83	AD[43]
12	KEYWAY	36	+3.3V	60	ACK64	84	AD[41]
13	KEYWAY	37	DEVSEL	61	+5V	85	Ground
14	RESERVED	38	GND	62	+5V	86	AD[39]
15	GND	39	LOCK	63	Reserved	87	AD[37]
16	CLK	40	PERR	64	Ground	88	+5V
17	GND	41	+3.3V	65	C/BE#[6]	89	AD[35]
18	REQ	42	SERR	66	C/BE#[4]	90	AD[33]
19	5V	43	+3.3V	67	Ground	91	Ground
20	AD31	44	C_BE1	68	AD[63]	92	Reserved
21	AD29	45	AD14	69	AD[61]	93	Reserved
22	GND	46	GND	70	+5V	94	Ground
23	AD27	47	AD12	71	AD[59]		
24	AD25	48	AD10	72	AD[57]		

TABLE A-7 PCI Edge Connector Pin Definitions (Bottom)

Pin	Description	Pin	Description	Pin	Description	Pin	Description
1	TRST	25	AD24	49	AD09	73	AD[56]
2	+12V	26	IDSEL	50	KEYWAY	74	AD[54]
3	TMS	27	+3.3V	51	KEYWAY	75	+5V
4	TDI	28	AD22	52	C_BE0	76	AD[52]
5	+5V	29	AD20	53	+3.3V	77	AD[50]
6	INTA	30	GND	54	AD06	78	Ground
7	INTC	31	AD18	55	AD04	79	AD[48]
8	+5V	32	AD16	56	GND	80	AD[46]
9	RESERVED	33	+3.3V	57	AD02	81	Ground
10	5V	34	FRAME	58	AD00	82	AD[44]
11	RESERVED	35	GND	59	5V	83	AD[42]
12	KEYWAY	36	TRDY	60	REQ64	84	+5V
13	KEYWAY	37	GND	61	+5V	85	AD[40]
14	RESERVED	38	STOP	62	+5V	86	AD[38]
15	RST	39	+3.3V	63	Ground	87	Ground
16	5V	40	SDONE	64	C/BE#[7]	88	AD[36]
17	GNT	41	SBO	65	C/BE#[5]	89	AD[34]
18	GND	42	GND	66	+5V	90	Ground
19	RESERVED	43	PAR	67	PAR64	91	AD[32]
20	AD30	44	AD15	68	AD[62]	92	Reserved
21	+3.3V	45	+3.3V	69	Ground	93	Ground
22	AD28	46	AD13	70	AD[60]	94	Reserved
23	AD26	47	AD11	71	AD[58]		
24	GND	48	GND	72	Ground		

