

SPARCstation 2 Field Service Manual

Sun Microsystems, Inc.
2500 Garcia Avenue
Mountain View, CA 94043
U.S.A.

Part No: 800-5166-10
Revision A of February 1991

© 1991 by Sun Microsystems, Inc.—Printed in USA.
2550 Garcia Avenue, Mountain View, California 94043-1100

All rights reserved. No part of this work covered by copyright may be reproduced in any form or by any means—graphic, electronic or mechanical, including photocopying, recording, taping, or storage in an information retrieval system— without prior written permission of the copyright owner.

The OPEN LOOK and the Sun Graphical User Interfaces were developed by Sun Microsystems, Inc. for its users and licensees. Sun acknowledges the pioneering efforts of Xerox in researching and developing the concept of visual or graphical user interfaces for the computer industry. Sun holds a non-exclusive license from Xerox to the Xerox Graphical User Interface, which license also covers Sun's licensees.

RESTRICTED RIGHTS LEGEND: Use, duplication, or disclosure by the government is subject to restrictions as set forth in subparagraph (c)(1)(ii) of the Rights in Technical Data and Computer Software clause at DFARS 252.227-7013 (October 1988) and FAR 52.227-19 (June 1987).

The product described in this manual may be protected by one or more U.S. patents, foreign patents, and/or pending applications.

TRADEMARKS

The Sun logo, Sun Microsystems, Sun Workstation, NeWS, and SunLink are registered trademarks of Sun Microsystems, Inc. in the United States and other countries.

Sun, Sun-2, Sun-3, Sun-4, Sun386i, SunCD, SunInstall, SunOS, SunView, NFS, and OpenWindows are trademarks of Sun Microsystems, Inc.

UNIX and OPEN LOOK are registered trademarks of UNIX System Laboratories, Inc.

PostScript is a registered trademark of Adobe Systems Incorporated. Adobe also owns copyrights related to the PostScript language and the PostScript interpreter. The trademark PostScript is used herein only to refer to material supplied by Adobe or to programs written in the PostScript language as defined by Adobe.

X Window System is a product of the Massachusetts Institute of Technology.

SPARC is a registered trademark of SPARC International, Inc. Products bearing the SPARC trademark are based on an architecture developed by Sun Microsystems, Inc. SPARCstation is a trademark of SPARC International, Inc., licensed exclusively to Sun Microsystems, Inc.

All other products or services mentioned in this document are identified by the trademarks, service marks, or product names as designated by the companies who market those products. Inquiries concerning such trademarks should be made directly to those companies.

Contents

About This Book	xiii
1. System Overview.	1
Major Components	8
Main Logic Board	8
CPU Core	9
SBus Slots	10
Memory Management Unit+.	10
S4 DMA+.	11
Dynamic RAM	11
Input/Output	11
Eight Bit Devices.	12
Single Inline Memory Modules (SIMMs).	14
SBus Boards	14
Mass Storage Devices.	15
Power Supply	16

Monitors	17
2. Diagnostics Overview	19
How It Fits Together	21
When to Use Diagnostics	22
Boot PROM Diagnostics	24
Power-On Self-Test (POST)	24
On-Board Diagnostics	29
Sundiag System Exerciser	30
SunDiagnostic Executive	31
Monitor and Forth Toolkit	31
3. Preparing to Work on the System	33
Halting the System	33
Tools Needed	36
Disconnecting Desktop Storage Packs	36
Disconnecting External Storage Modules	36
Removing the System Unit's Cover	37
Attaching a Wrist Strap	39
4. FRU Replacement	41
Before You Begin	42
Removing and Replacing FRUs	42
FRU Identification	42
Single Inline Memory Modules (SIMMs)	46
Determining Faulty SIMM Locations	46
SBus Boards	54

Power Supply	58
Hard Disk Drive	60
Diskette Drive	68
Fan Assembly	72
Main Logic Board	75
Serial Port Jumpers.	76
Main Logic Board Voltage Test Points	79
Before Replacing the Main Logic Board	83
Removing the Main Logic Board	88
Preparing Main Logic Board for Replacement	89
Replacing the Main Logic Board.	90
Boot PROM	93
NVRAM/TOD.	94
Speaker.	95
Replacing the System Unit's Cover	98
Connecting the Desktop Storage Pack	99
Connecting the External Storage Module	99
Video Monitors	100
Mouse.	100
Keyboard	100
How to Turn the Power Back On	100
A. System Specifications	103
Regulatory Compliance	103
Input Power Requirements	104

Environmental Requirements	104
Physical Specifications	105
B. Illustrated Parts Breakdown	107
Parts Breakdown	107
C. FRU List	113
FRU List	113
D. Open Boot PROM	115
Open Boot PROM	115
Glossary	119
Index	125

Figures

Figure 1-1	SPARCstation 2 Block Diagram.	2
Figure 1-2	Top View of the System With the Cover Removed	3
Figure 1-3	The Workstation's Main Logic Board.	4
Figure 1-4	Block Level Diagram of the Main Logic Board.	7
Figure 2-1	Default Boot Mode	20
Figure 2-2	Arrangement of Keyboard LEDs.	25
Figure 2-3	Keyboard LED Diagnostic Codes.	26
Figure 2-4	Location of SIMM Slots in System Unit	27
Figure 2-5	SIMM Slot Locations on Main Logic Board.	28
Figure 2-6	Halting the System and Displaying On-Board Diagnostics . .	30
Figure 3-1	System Unit Back Panel	38
Figure 3-2	The System Unit's Cover	38
Figure 4-1	Top View of the System With the Cover Removed	43
Figure 4-2	Boards and Modules (continued on next page)	44
Figure 4-2	Boards and Modules (continued)	45
Figure 4-3	SIMM Extraction Tool.	49

Figure 4-4	Inserting the SIMM Extraction Tool	49
Figure 4-5	Final Manual Removal of a SIMM	50
Figure 4-6	Location of SIMM Slots in System Unit	51
Figure 4-7	SIMM Slot Location on Main Logic Board.	52
Figure 4-8	4 Megabyte SIMM: Horizontally-mounted Chips	53
Figure 4-9	Removing and Replacing the Power Supply.	60
Figure 4-10	Hard Disk Drive with 6 Jumpers—Jumper Setting for Drive 1	64
Figure 4-11	Hard Disk Drive with 5 Jumpers—Jumper Setting for Drive 1	64
Figure 4-12	Hard Disk Drive with 6 Jumpers—Jumper Setting for Drive 2	65
Figure 4-13	Hard Disk Drive with 5 Jumpers—Jumper Setting for Drive 2	65
Figure 4-14	Removing and Replacing the Hard Disk Drive.	67
Figure 4-15	Connecting Power and Data Cables to the Hard Disk Drive .	68
Figure 4-16	Removing and Replacing the Diskette Drive	70
Figure 4-17	Connecting Power and Data Cables to the Diskette Drive . . .	72
Figure 4-18	Removing and Replacing the Fan Assembly.	74
Figure 4-19	Connecting "Y" Power Cable to Fan Assembly.	75
Figure 4-20	Top View of System Unit's Internal Parts	77
Figure 4-21	Serial Port Jumpers	78
Figure 4-22	Preset RS-423 Jumper Positions.	78
Figure 4-23	RS-232 Jumper Positions.	79
Figure 4-24	Pin Location of Power Supply Connector (J0701).	80
Figure 4-25	Main Logic Board Layout.	81
Figure 4-26	Removing and Replacing the Main Logic Board	92
Figure 4-27	Replacing the System Unit's Cover.	99
Figure B-1	System Interconnection	108

Figure B-2	Exploded View of the System Unit.	109
Figure B-3	Exploded View of the System Unit Showing Drive Bracket. . .	110
Figure B-4	Exploded View of the Main Logic Board in the System Unit. . .	111

Tables

Table 1-1	Main Logic Board Parts Layout: Legend	5
Table 1-2	List of Acronyms	6
Table 1-3	Video Monitor Types	17
Table 2-1	Summary of Available Diagnostic Tool	23
Table 2-2	Table of Memory Banks	28
Table 4-1	Table of Memory Banks	52
Table 4-2	Table of Hard Disk ID Jumper Settings	62
Table 4-3	Main Logic Board Parts layout: Legend	82
Table 4-4	List of Acronyms	83
Table A-1	Regulatory Compliance Information	103
Table A-2	Input Power Requirements and Power Dissipation for the System Unit	104
Table A-3	Table of Environmental Requirements	104
Table A-4	Table of Physical Specifications	105
Table B-1	System Components and Their Part Numbers	108
Table C-1	FRU List (continued on next page)	113

About This Book

The *SPARCstation™ 2 Field Service Manual* describes how to diagnose system problems by running diagnostic programs and removing and replacing field replaceable units (FRUs). Appendix C lists the FRU part numbers.

Who Should Read This Book

This book is written for Sun Field Service representatives, original equipment manufacturers (OEMs), value-added resellers (VARs), and other customers with self-maintenance contracts.

What This Book Contains

This book contains four chapters, four appendices and a glossary:

- **System Overview—Chapter 1**
This chapter presents a high-level description of the SPARCstation 2 system, followed by brief descriptions of each subsystem. Read this chapter to gain a general familiarity with the hardware.
- **Diagnostics Overview—Chapter 2**
This chapter describes the different types of diagnostics and how they are related. This chapter also briefly discusses the Forth Toolkit. Read this chapter to gain general knowledge about the diagnostic and Forth Toolkit tools available to you.

-
- **Preparing to Work on the System—Chapter 3**
This chapter explains how to halt the system, tools you will need, how to disconnect the Desktop Storage Pack and the External Storage Module from the system unit, how to remove the system unit's top cover, and how to attach a wrist strap to your wrist and to the system chassis. **Read this chapter before replacing any hardware.**
 - **FRU Replacement—Chapter 4**
This chapter explains how to locate, remove, and replace defective field-replaceable units (FRUs) or install new ones. Drawings and callouts are provided to illustrate the process. **Read this chapter before attempting to replace any hardware.**
 - **System Specifications—Appendix A**
This appendix contains system specifications, including dimensions, electrical and power requirements, environmental constraints, and compliance with various electrical and safety regulations.
 - **Illustrated Parts Breakdown—Appendix B**
This appendix contains illustrations of global views of the system.
 - **FRU list—Appendix C**
This appendix contains the FRU list for SPARCstation 2.
 - **OpenBoot PROM—Appendix D**
This appendix contains the Alias and Boot Paths table and the Non-Volatile Random Access Memory (NVRAM) parameters used during reset. These parameters control the system configuration.
 - **Glossary**
The glossary contains definitions of technical terms, abbreviations, and acronyms.

Before Reading This Book

Before reading this book, you should have performed hardware installation. If you are connecting to a network, you should also be proficient with system administration and networking procedures. If you are not proficient in these areas, please read the following books before attempting to repair your system:

- *SPARCstation 2 Installation Guide*
- *Sun System & Network Manager's Guide*

Typographic Conventions

This book uses a number of typographic conventions:

- *This font* is used for emphasis and for the title of a book. For example: The heart of the SPARCstation 2 is contained in a *main chassis*, or system unit.

SPARCstation 2 Installation Guide

- `This font` indicates text the system displays on the screen. This font also indicates characters and words you enter (as shown within text).

Examples follow:

```
Syncing file systems... done
```

```
Enter passwd.
```

- `This font` indicates what you type as illustrated in screen examples. For example:

```
% sync
```

- `This font` also indicates a key that you press. For example: Press the `Delete` key.

When you see two key names, press and hold the first key, then type the second character. For example:

When you see `L1-A`, press and hold `L1`, while typing `A`.

- The term “enter” means to type the command indicated and press the Return key. For example, “enter `sync`” means to type the command indicated and press the `Return` key.

Related Books

The following books provide additional information that you may need, and are occasionally referenced in this manual:

- *Open Boot PROM 2.0 Toolkit User's Guide* provides a summary of the Forth Toolkit commands.

-
- *Sundiag User's Guide* covers information about Sundiag, a system exerciser that runs under the SunOS™ Operating System. Sundiag displays real-time use of system resources and peripherals.
 - *SPARCstation 2 Installation Guide* provides step-by-step instructions on how to install the system's hardware and software.
 - *Installing SPARCstation 2 SIMMs* provides step-by-step information on how to install SIMMs in the SPARCstation 2.
 - *Installing SPARCstation 2 Internal Drives* provides information on how to install internal drives in the SPARCstation 2.
 - *Sun System & Network Manager's Guide* describes system and network management tasks for maintaining a single Sun workstation or a small network of Sun workstations.
 - *Desktop Storage Pack Installation Guide* explains how to install and daisy-chain external storage modules.
 - *External Storage Module Installation Guide* provides step-by-step information on how to install disk and tape drives that can be connected to a SPARCstation 2.
 - *Sun System User's Guide* covers the basics of using the SPARCstation 2 so that you can get to work quickly. It will introduce you to the mouse and keyboard, to SunView™ windows, and to the SunOS operating system.
 - *SunDiagnostic Executive User's Guide for SPARCstations* explains how to run extensive, configurable tests independent of SunOS. The Sun Diagnostic Executive is the tool of choice when you need thorough diagnostics. With the Sun Diagnostic Executive you can determine which field replaceable unit needs to be replaced.

System Overview



This chapter presents an overview of the SPARCstation 2 system's hardware. This overview is helpful in servicing and maintaining hardware equipment.

The heart of the SPARCstation 2 is contained in a main chassis or *system unit*. The system unit houses the main logic board. A power supply, two optional 3 1/2-inch hard disk drives, one optional 3 1/2-inch diskette drive, and the speaker are also contained in the system unit. A frame buffer board or graphics accelerator board must reside in one of the system's three SBus expansion slots when a video monitor is connected to the system. See "SBus Boards" later in this Chapter for more information.

You can add expansion modules to increase the system's mass storage capacity. See "Mass Storage Devices" later in this chapter for more information on the expansion modules.

The figures and tables covered in this chapter include the following:

- Figure 1-1 illustrates the system's configuration with an external storage device.
- Figure 1-2 presents the top view of the system with the cover removed.
- Figure 1-3 presents the main logic board's layout.
- Table 1-1 gives the legends to be used with Figure 1-3.
- Table 1-2 lists the acronyms used for certain parts, and their full expressions.
- Figure 1-4 presents the block-level diagram of the main logic board. The balance of the chapter describes the system's components.

Figure 1-1 is a block diagram of one of the workstation's configurations.

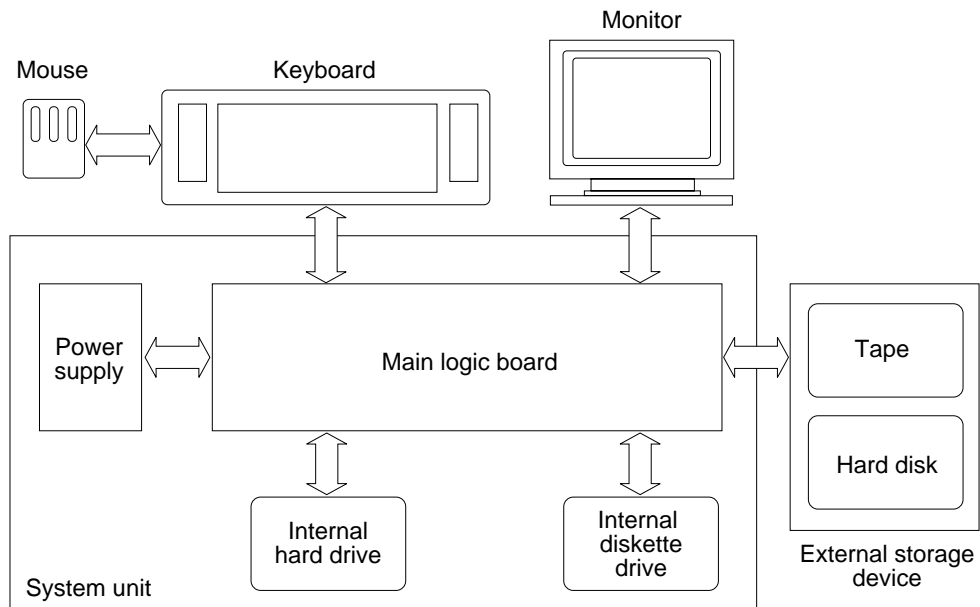

Figure 1-1 SPARCstation 2 Block Diagram

Figure 1-2 shows the top view of the system with the cover removed.

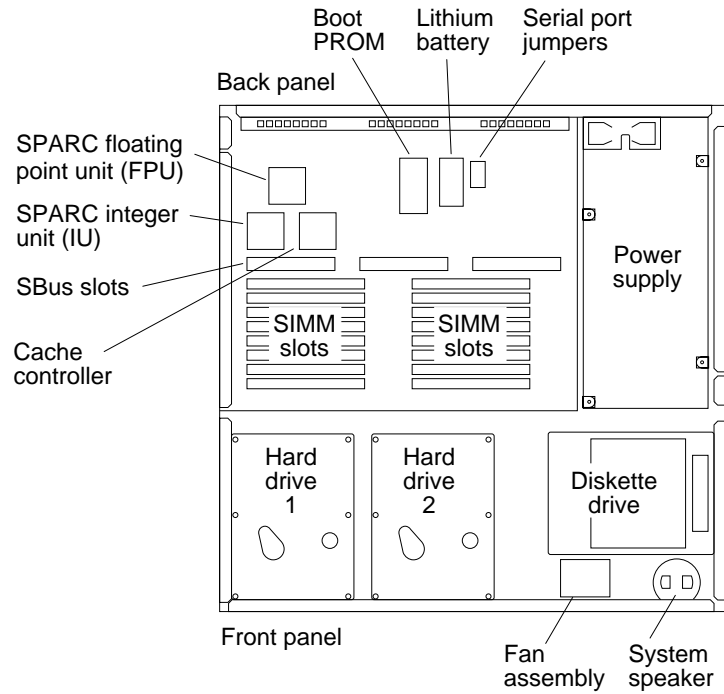

Figure 1-2 Top View of the System With the Cover Removed

Figure 1-3 illustrates the main logic board's layout. All the chips discussed in "Main Logic Board," which follows, are illustrated in this figure.

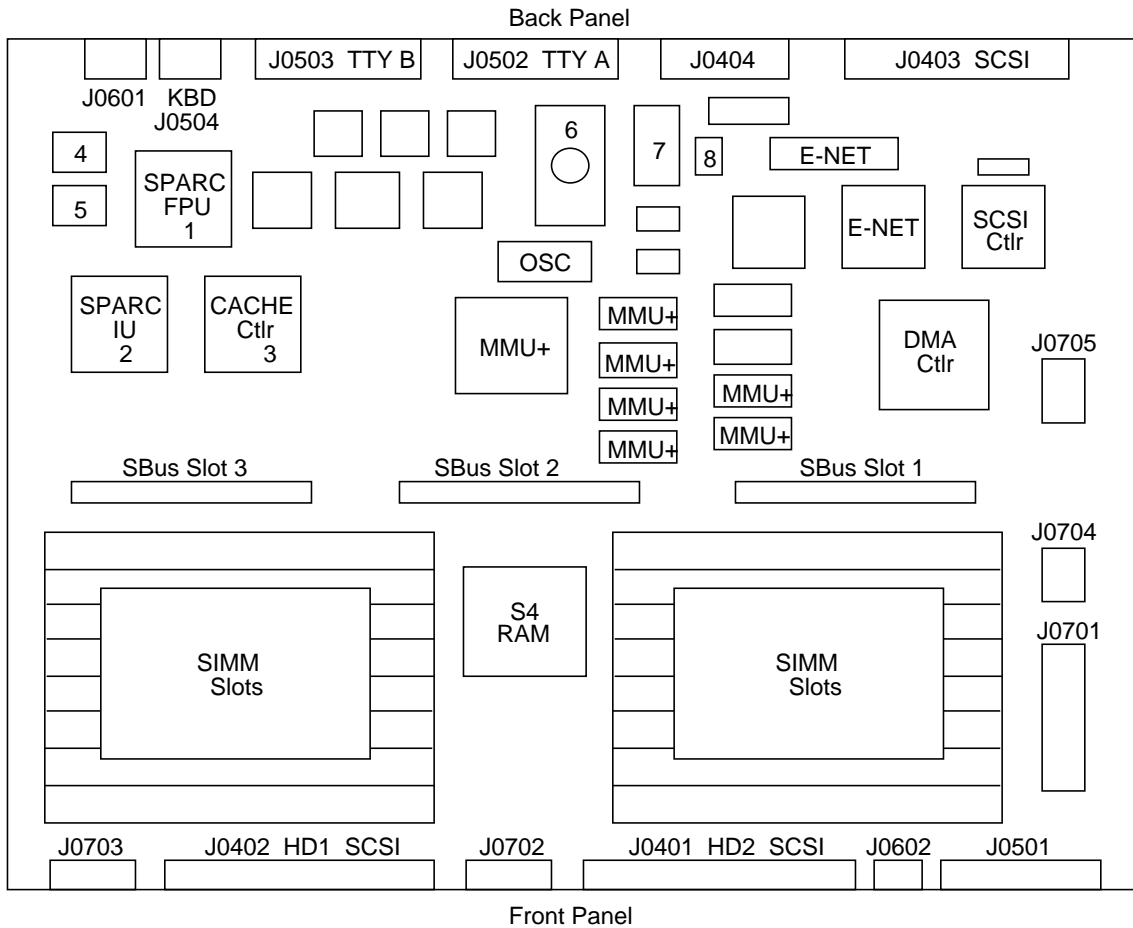

Figure 1-3 The Workstation's Main Logic Board

Table 1-1 Main Logic Board Parts Layout: Legend

Figure 1-3	Definition
1	SPARC Floating Point Unit
2	SPARC Integer Unit
3	Cache Controller
4	Cache Data RAM (chip set)
5	Cache Data RAM (chip set)
6	Boot PROM
7	NVRAM, Time-of-Day Clock, Lithium Battery
8	RS-232 and RS-423 serial port mode jumpers
DMA CTRL	DMA Controller, S4 DMA+
E-NET	Ethernet Controller (chip set)
MMU+	Memory Management Unit+ (chip set)
OSC	Oscillator
RAM CTRL	RAM Controller, S4 RAM
SCSI Ctrl	SCSI Controller
SIMM	Single Inline Memory Module
J0401	Hard Drive 2 SCSI cable connector
J0402	Hard Drive 1 SCSI cable connector
J0403	SCSI port
J0404	Ethernet port
J0501	Diskette Drive data cable connector
J0502	Serial Port A
J0503	Serial Port B
J0504	Keyboard cable connector
J0601	Audio Input/Output cable connector
J0602	System Speaker and LED connector
J0701	Power Supply connector
J0702	Hard Drive 2 power connector
J0703	Hard Drive 1 power connector
J0704	Diskette drive power connector
J0705	Memory/SBus expansion connector

Table 1-2 List of Acronyms

Acronyms	Full Expression
DMA	Direct Memory Access
MMU+	Memory Management Unit+
NVRAM	Non-Volatile Random Access Memory
PROM	Programmable Read-Only Memory
RAM	Random Access Memory
SCSI	Small Computer System Interface
SIMM	Single Inline Memory Module

Major Components

The system's major components usually consist of the following:

- The system unit
- The keyboard
- The video monitor (or a terminal)
- The mouse
- Optional external storage modules. The following are some of the external storage modules available:
 - Desktop Backup Pack 150 MB (megabyte) tape drive only
 - Desktop Disk Pack 207 MB hard disk drive only
 - Desktop SunCD Pack 644 MB (maximum) CD-ROM player only
 - External Storage Module 327 MB hard disk drive only
 - External Storage Module 327 MB hard disk drive and 150 MB cartridge tape drive
 - External Storage Module dual 327 MB hard disk drives
 - External Storage Module 669 MB hard disk drive only
 - External Storage Module dual 669 MB hard disk drives
 - External Storage Module 669 MB hard disk drive and 150 MB cartridge tape drive
 - External Storage Module 669 MB hard disk drive and 2.3 GB cartridge tape drive
 - External Storage Module 2.3 GB cartridge tape drive only

These units may be daisy-chained together. For information on installing and using external drive unit, see the *Desktop Storage Pack Installation Guide*.

Main Logic Board

The major sections of the main logic board consist of the following:

- CPU core
- SBus slots
- Memory Management Unit+ (MMU+)
- S4 Direct Memory Access+ (DMA+)

- Dynamic Random Access Memory (RAM)
- Input/Output such as the Ethernet controller chip, the SCSI controller chip, and the diskette drive controller chip
- Eight-bit devices

CPU Core

The CPU core consists of the following:

- Integer Unit (IU)
- Floating-point Unit (FPU)
- Cache memory

These components are discussed in the sections that follow.

Integer Unit

The basic core of the main logic board is the SPARC Integer Unit (IU) (see Figures 1-3 and 1-4). The IU's clock speed is 40 MHz. The IU is supported with the S4 chip set including the S4 cache+, the S4 memory management unit+, the S4 buffer, and the S4 clock.

Floating-Point Unit

The floating-point unit (see Figures 1-3 and 1-4) delivers approximately 4.0 Mflops double-precision Linpack performance.

Cache Memory

Cache memory (see Figures 1-3 and 1-4) is high-speed local memory for the IU. The chips comprising cache memory include the following:

- S4 Cache+
- Cache Data RAMs

The S4 cache chip serves as the SBus controller and the address path. The S4 buffer chip controls the data path through the cache. The S4 cache chip also controls what data is available in the cache data RAMs.

The IU asks for data from a specific address. That address is compared against information stored in the cache tags. The S4 cache chip decides if the data the IU is looking for is stored in the cache, based on the information stored in the cache tags.

If the data is in the cache, the cache data RAM transmits data to the IU as fast as the IU can receive data. If the data is not in the cache, this is referred to as a cache miss, and the IU is halted. An SBus cycle is initiated to obtain the required data from main memory. The cache data RAM is filled with the information obtained from main memory and the IU is started again.

The cache design implemented in the SPARCstation 2 is a 64 K write-through cache with one level of write buffering. The cache line size is 16 bytes, with one tag for each line.

SBus Slots

There are three SBus slots on the main logic board (see Figures 1-2 and 1-3). SBus boards such as frame buffer board, a GX graphics accelerator board, or a second ethernet board are installed in the SBus slots.

The SBus slots are connected to the SBus data bus and the SBus address bus. The SBus is a proprietary 32-bit synchronous bus. See “SBus Boards” later in this chapter for more information on specific SBus boards. “SBus Boards” in Chapter 4 explains how to remove and replace SBus boards.

Memory Management Unit+

The S4 memory management unit+ (MMU+) chip (see Figures 1-3 and 1-4) is connected to the system bus. The MMU+ maps the virtual addresses used by user programs, SunOS, and input/output devices to physical memory addresses. This is how virtual memory is implemented. Virtual memory allows a user program to have access to an address space that is larger than the physical memory present on the system.

In addition, it isolates the address space of one process from that of another, preventing errors in a user-level program from bringing the entire system down. It also controls the protections (read-only or read/write) associated with each page of memory, allowing, for example, one copy of a shared library to be used by many running programs.

S4 DMA+

Ethernet is controlled by a Local Area Network Controller for Ethernet (LANCE) controller chip (see Figures 1-3 and 1-4). It interfaces to the SBus through the S4 DMA+ chip. SCSI disk drive operations are handled through the SCSI controller chip. It also interfaces to the SBus through the S4 DMA+ chip.

Dynamic RAM

The Dynamic RAM (DRAM), is comprised of the following:

- One S4 RAM chip, illustrated in Figures 1-3 and 1-4.
- 16 Single Inline Memory Module (SIMM) slots for 4 MB SIMMs in groups of 4. See “Single Inline Memory Modules (SIMMS)” in Chapter 4 and *Installing SPARCstation 2 SIMMs* for information on how to install SIMMS.

Input/Output

The following chips, which control input/output devices, are briefly discussed in this section:

- Ethernet (LANCE) controller chip
- SCSI controller chip
- Diskette drive controller chip

Ethernet is controlled by a Local Area Network Controller for Ethernet (LANCE) controller chip (see Figures 1-3 and 1-4).

The SCSI hard disk drives are controlled by the SCSI controller chip (see Figures 1-3 and 1-4).

The diskette drive is controlled by the diskette drive controller chip (see Figure 1-4).

Eight Bit Devices

The eight-bit devices connected to the I/O data bus consist of the following:

- **Boot PROM**

The boot PROM (see Figures 1-3 and 1-4) is connected to the I/O data bus. The boot PROM is 256Kx8 in size and contains the boot code, diagnostics, and the Forth Toolkit, signified by the `ok` prompt. The Forth Toolkit does not look like other Sun Monitor programs and does not behave like the older Sun PROMs.

The boot PROM does the following:

- a. Runs startup diagnostic tests.
 - b. Initializes the host machine.
 - c. Reads non-volatile RAM (NVRAM) and executes the boot sequence. Usually, this consists of booting SunOS. In some cases, however, the SunDiagnostic Executive or standalone programs can also be run. For more information on the boot sequence, see “How It Fits Together” in Chapter 2.
 - d. Supplies program code for the abbreviated system monitor, signified by the `>` prompt and the Forth Toolkit. If the boot attempt fails, the boot PROM tries to start the abbreviated system monitor.
 - e. Supplies program code for the on-board diagnostics accessible through the Forth Toolkit. For more information on the on-board diagnostics, see “Boot PROM Diagnostics” in Chapter 2.
- **Non-volatile RAM (NVRAM) and Time-of-Day Clock**

The NVRAM chip (see Figures 1-3 and 1-4) contains the time-of-day clock and the non-volatile RAM. The NVRAM chip is connected to the I/O data bus.

The NVRAM chip contains its own battery. There is no limit on the number of times the NVRAM chip can be written to.

The non-volatile RAM stores the default system configuration parameters. The default parameters are listed in Appendix D. This defines how the system will be set up at the lowest level. You can modify these parameters

using the Forth Toolkit. If you need to change these parameters, see “Appendix B, NVRAM Configuration Parameters Summary” in the *Open Boot PROM 2.0 Toolkit User's Guide*.

- **Serial Ports A and B**

Serial ports A and B are provided on the main logic board (see Figure 1-3). These serial ports are RS-423 or RS-232 ports and can connect peripheral equipment such as terminals, printers, and modems. The serial ports on the SPARCstation 2 are set to operate in synchronous or asynchronous RS-423 mode.

The serial ports can be reconfigured by changing jumpers on the main logic board to run at RS-232 for users in the Federal Republic of Germany. Both ports must be configured for either RS-423 or RS-232 mode. The serial communications controller chips (see Figure 1-4) help to implement the serial port A and B interface. Refer to Chapter 4 “Main Logic Board” for information on how to set the serial port jumpers.

- **Keyboard and Mouse Interface**

A keyboard port, on the back of the main logic board to the left of the Serial B port (see Figure 1-3), controls the keyboard and mouse. The serial communications controller chips (see Figure 1-4) help to implement the keyboard and mouse interface.

- **Diskette Drive Controller**

The internal diskette drive is connected to the I/O data bus by the diskette drive controller chip (see Figure 1-4).

- **Audio**

The system speaker is connected to the I/O data bus by the audio chip (see Figure 1-4). There is one audio port on the back panel. You can plug the following devices into the audio input/output port:

- Dynamic, high-impedance microphone (10,000 ohms to 50,000 ohms impedance)
- Dynamic, low-impedance microphone (300 ohms to 1000 ohms impedance)
- Audio tape player equipped with attenuating adapter
- Compact disc player equipped with attenuating adapter
- Headphones (30 ohms to 100 ohms impedance)
- External amplifier and loudspeaker

The workstation's sound capabilities can be shown with Soundtool, an audio demonstration program included with SunOS. To test the workstation's sound, see "Speaker" in Chapter 4. For additional information, see "SunOS Features" in Chapter 6 of the *SPARCstation 2 Installation Guide*, and "Appendix C" in the *Sun System User's Guide*.

Single Inline Memory Modules (SIMMs)

At present, up to 64 MBs of memory, contained in 4 MB Single Inline Memory Modules (SIMMs), can be added in increments of 16 MBs (see Figures 1-2, 1-3, and 1-4). See "Single Inline Memory Modules (SIMMs)" in Chapter 4 for SIMM installation and removal instructions. Also refer to *Installing SPARCstation 2 SIMMs*.

SBus Boards

Various SBus boards can be added to the system's three SBus slots on the main logic board. Figures 1-2, 1-3 and 1-4 illustrate the SBus slots. See "SBus Boards" in Chapter 4 for information on how to remove and replace SBus boards. The following is a list of some of SBus boards available for a SPARCstation 2. Note that this is not an inclusive list of all SBus boards available for the SPARCstation 2.

- **GX Graphics Accelerator Board**
This board controls the video output from the system unit, and accelerates the generation of graphic images. The GX Graphics Accelerator board occupies two SBus slots on the main logic board.
- **Color Frame Buffer Board**
This board occupies one SBus slot. This board controls the video output from the system unit to a color monitor.
- **Second Ethernet Board**
This board provides you with an extra Ethernet port. The Ethernet board is used in applications in which your SPARCstation 2 acts as a gateway between two physically distinct Ethernet networks. This board has two connectors: standard (thick) Ethernet and thin Ethernet, and occupies one SBus slot.

- **GS Graphics Accelerator Board**
This option consists of two boards that are plugged to each other on their component sides. They are triple-wide SBus boards and occupy three SBus slots. Figure 4-2 shows the top side of GS Graphics Accelerator Board when it is installed in the system unit. This option provides 24-bit color and 3 dimensional graphics capabilities. It also requires a 76 Hz color monitor.
- **Video Frame Capture Board**
This board occupies one SBus slot. This board takes video input and displays it on color or monochrome monitors.
- **SBus Printer Card**
This board occupies one SBus slot. This board connects the system to printing, plotting and scanning devices.
- **1-Bit Analog Frame Buffer Board**
This board occupies one SBus slot. It controls the video output from the system to a monochrome monitor.

Mass Storage Devices

The following is some of the mass storage devices available. Note that the following list is not necessarily an inclusive list of mass storage devices available for SPARCstation 2.

- **Hard disk drives**
Two optional 3 1/2-inch SCSI 207 MB hard disk drives (see Figure 1-2) can be installed in the system unit. Chapter 4 describes how to replace the optional hard disk drives in the system unit.
- **Optional expansion modules. The following are available:**
 - Desktop Storage Packs (DSPs)**
 - Desktop Backup Pack 150 MB SCSI-compatible tape drive only
 - Desktop Disk Pack 207 MB hard disk drive only
 - Desktop SunCD Pack 644 MB (maximum) CD-ROM only
 - External Storage Modules (ESMs)**
 - External Storage Module 327 MB hard disk drive only
 - External Storage Module 327 MB hard disk drive and 150 MB cartridge tape drive
 - External Storage Module dual 327 MB hard disk drives

- External Storage Module 669 MB hard disk drive only
- External Storage Module dual 669 MB hard disk drives
- External Storage Module 669 MB hard disk drive and 150 MB cartridge tape drive
- External Storage Module 669 MB hard disk drive and 2.3 GB cartridge tape drive

◦ External Storage Module 2.3 GB cartridge tape drive only
These units may be daisy-chained together. By attaching optional expansion units, you can increase the system's mass storage capacity. For information on installing and using external drive units, see the *Desktop Storage Pack Installation Guide* or the *External Storage Module Installation Guide*.

- Diskette drive
An optional 3 1/2-inch 1.44 MB internal diskette drive (see Figure 1-2) can be installed in the system unit. The drive accepts a 4-pin AMP power connector and a 34-pin data cable. The data transfer rate is 1 Mbps (Mbit per second). "Diskette Drive" in Chapter 4 describes how to remove and replace the optional diskette drive in the system unit.

Power Supply

The power supply (see Figure 1-2) is housed in the system unit. It connects to the system via a 12-pin connector and provides +5, +12, and -12 volts DC. Voltages are regulated. The power supply also supplies the power-on reset signal.

Some of the power supply's features include the following:

- Switching power supply
- Overcurrent protection
- Crowbar feature
- Internal fusing

The External drive units have their own power supplies. The External Storage Module's power supply provides +5, +12, and -12 volts DC. The Desktop Storage Pack's power supply provides +5 and +12 volts DC.

Monitors

Each system accepts a keyboard, an optical mouse, and one of several types of video monitors.

See Appendix C for the available monitors. See Table 1-3 for the supported monitors.

Table 1-3 Video Monitor Types

Monitor Type	Voltage
16-inch color monitor (407 mm)	115 V
16-inch color monitor (407 mm)	240 V
19-inch standard grayscale monitor (483 mm)	90-240 V
19-inch high-resolution monochrome monitor (483 mm)	115 V
19-inch high-resolution monochrome monitor (483 mm)	240 V
17-inch grayscale (432 mm)	90-240 V
19-inch Sony color monitor (483 mm)	115 V
19-inch Sony color monitor (483 mm)	240 V
16-inch color overscan monitor (407 mm)	90-240 V
19-inch color overscan monitor (483 mm)	90-240 V
17-inch grayscale overscan monitor (432 mm)	90-240 V
19-inch grayscale overscan monitor (483 mm)	90-240 V

Diagnostics Overview



This chapter describes the different types of diagnostic firmware and software tools available to you and how they are related. The main categories of diagnostics are:

- Boot PROM diagnostics
 - Power-On Self-Test (POST)
 - On-Board Diagnostics
- Sundiag System Exerciser
- SunDiagnostic Executive

Besides these categories of diagnostics, this chapter briefly covers the Forth Toolkit, which is an interactive command interpreter based on the Forth programming language. For a more complete discussion of the Sun Forth Toolkit, see the *Open Boot PROM 2.0 Toolkit User's Guide*.

The Forth Toolkit gives you access to an extensive set of functions for performing the following:

- Hardware development
- Problem determination (fault isolation)
- Software development
- Debugging

All functions available through the Monitor `>` prompt, except entering the Forth Toolkit, are also available through the Forth Toolkit.

The flowchart in Figure 2-1 outlines the roles played by various diagnostics during the default boot mode.

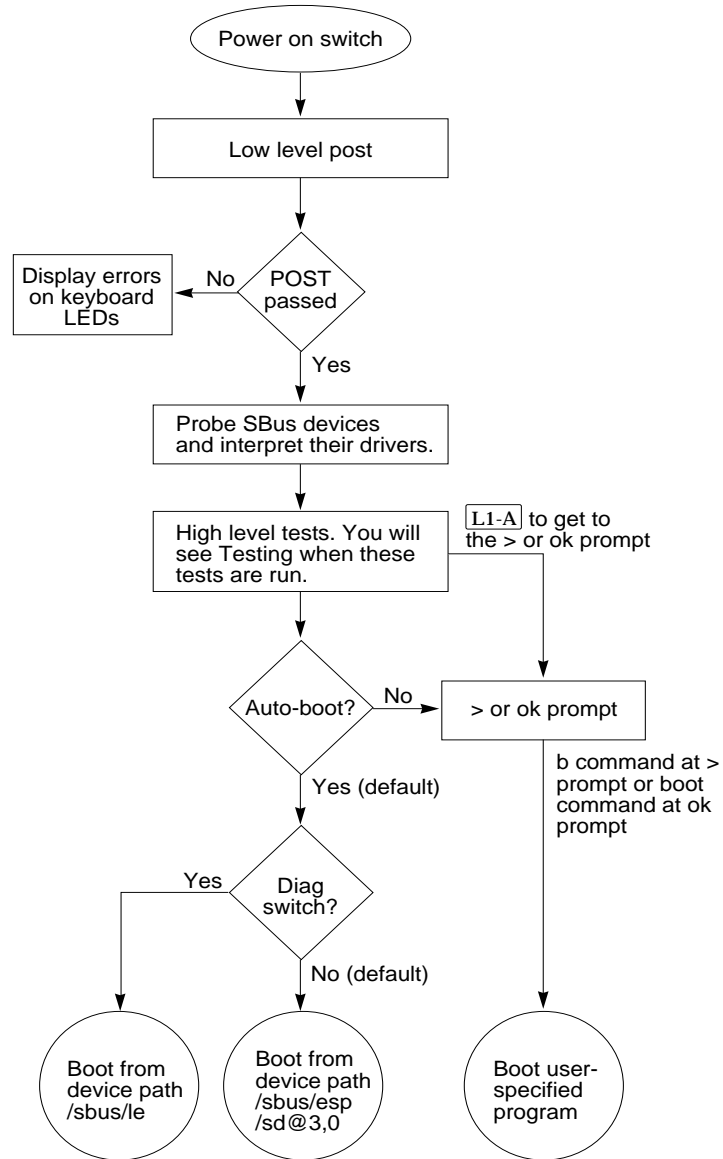

Figure 2-1 Default Boot Mode

How It Fits Together

This section describes how the various diagnostic tools work together in the different power-on modes. This description assumes you are using a graphics monitor to view test results. The flowchart in Figure 2-1 outlines the roles played by various diagnostics during the default boot mode.

When you turn on system power, the low-level POST code, stored in the boot PROM, is executed. While low-level POST code is executing, you will see the four LEDs on the keyboard flashing to indicate that testing is in progress. If a failure occurs in POST, the failing field replaceable unit (FRU) is encoded on the four LEDs located on the Type-4 keyboard. See “Power-On Self-Test” later in this chapter for more information.

If the POST passes, the system probes for SBus devices and interprets their drivers. Next, high level tests are performed. You will see the word `Testing` while the high level tests are running. After `Testing` is displayed, if you want to enter the Monitor, (indicated by the `>` prompt), press the `LI-A` keys simultaneously.

If the autoboot switch parameter is set to false (not the default), you will obtain either the `>` or `ok` prompt. The `>` prompt is the default prompt. You can change the default prompt to obtain the `ok` prompt, the Forth Toolkit prompt, as the default. To make the `ok` prompt the default prompt, see the *Open Boot PROM 2.0 Toolkit User's Guide*.

If the autoboot switch parameter is set to true (default), and the diagnostic switch parameter is set to false (default), SunOS is booted using the device path `/sbus/esp/sd@3,0`. If the autoboot switch parameter is set to true (default), and the diagnostic switch parameter is set to true (not the default), SunOS is booted using the device path `/sbus/le`.

To boot user-specified programs, such as the SunDiagnostic Executive, you must be at the `>` or `ok` prompt. See “On-Board Diagnostics” later in this chapter for a detailed procedure on how to obtain the `>` and `ok` prompts.

Autoboot Switch Parameter	Diagnostic Switch Parameter	Results
False	(Don't care)	> or ok prompt
True	False	boot SunOS (vmunix) from disk 0* (/sbus/esp/sd@3,0)
True	True	boot SunOS (vmunix) from network* (/sbus/le)

When to Use Diagnostics

You should use each type of diagnostic tool in the appropriate circumstances. Table 2-1 provides a summary of the available diagnostic tools, and lists when to use each diagnostic tool.

Table 2-1 Summary of Available Diagnostic Tool

Diagnostic Tool	When or why to use
Power-On Self-Test	Executes automatically at power-on. The POST code resides in the boot PROM and is driven by the Por signal from the power supply. POST tells you if the major hardware components of the main logic board, the frame buffer, and the hard disk fails. Described later in this chapter.
On-Board Diagnostics	Test such as the Ethernet test, and the diskette drive controller test are available. You must be in the Forth Toolkit to run on-board diagnostics. Enter n from the > prompt to enter the Forth Toolkit. The On-Board diagnostics reside in the boot PROM. Described later in this chapter.
Sundiag System Exerciser	Runs under SunOS. It displays real-time use of the system resources and peripherals. The Sundiag System Exerciser tells you if your system is functioning correctly or not. If Sundiag fails, run the Power-On Self-Test. If all power-on self-tests pass, then run the SunDiagnostic Executive to identify the problem. See the <i>Sundiag User's Guide</i> for more information.
SunDiagnostic Executive	Runs extensive, configurable subsystem tests independent of SunOS. Run the SunDiagnostic Executive if all tests pass when you run POST. Running the SunDiagnostic Executive allows you to troubleshoot which field replaceable unit needs to be replaced. See the latest version of <i>SunDiagnostic Executive User's Guide for the SPARCstations</i> for more information.
Monitor	Enters the Monitor when the operating system crashes. To bot SunOS or another program from the > prompt, enter b. To resume execution of a halted program from the > prompt, enter c. To enter the Forth Toolkit from the > prompt, enter n. Described later in this chapter.
Forth Toolkit	Performs all functions available through the Monitor, except entering the Forth Toolkit. Changing NVRAM parameters. Resetting the system. Running diagnostics. Displaying system information. Redirecting input and output. See the <i>Open Boot Prom 2.0 Toolkit User's Guide</i> for more information.

Boot PROM Diagnostics

The diagnostics stored in the boot PROM include the following:

- Power-On Self-Test
- On-Board Diagnostics

The Power-On Self-Test (POST) is the default mode. If there is system trouble, you may want to run extended on-board diagnostics to take advantage of thorough tests including — but not limited to — Ethernet, memory, and diskette drive tests. See Figure 2-3 for the table of keyboard LED diagnostic codes.

The boot PROM diagnostics are described in the following sections.

Power-On Self-Test (POST)

The Power-On Self-Test (POST) runs automatically when you turn on the system's power switch or reboot the system. The POST code, which resides in the boot PROM, is executed by the CPU (IU) when the Por signal is received from the power supply. Por is a Power-On reset TTL open collector signal from the power supply, which is activated after DC voltages have risen. The POST consists of a sequence of tests designed to test the major hardware components of the main logic board, in a short time before SunOS is booted. POST does not perform extensive testing on any component of the main logic board. Only major failures can be detected by POST. If a failure occurs in POST, a specific LED pattern is displayed on the four LEDs located on the upper right corner of your keyboard. Figure 2-2 shows the arrangement of keyboard LEDs.

Following the system's successful initialization, SunOS is booted automatically, unless the NVRAM configuration options specify not to do so.

Power-On Self-Test Detailed Description

This section describes the keyboard LED patterns as a result of POST and their meaning. Figure 2-2 shows the arrangement of keyboard LEDs.

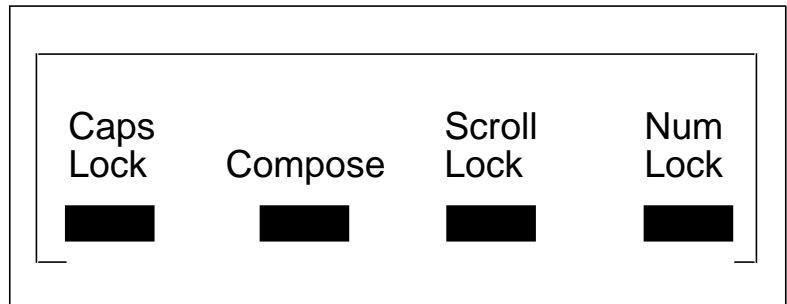

Figure 2-2 Arrangement of Keyboard LEDs

Figure 2-3 shows the LED display patterns, the field replaceable units (FRUs) that fail power-on tests, and the meaning of the display patterns.

Figure 2-4 shows the location of the SIMM slots in the system unit. Figure 2-5 shows how the SIMM slots are identified on the main logic board. Table 2-2 identifies memory banks and slots.

LED Display Pattern	FRU	Meaning of Pattern
		Unassigned. Testing completed, SunOS is booted.
	Boot PROM	Bad checksum in boot PROM.
	NVRAM/TOD	NVRAM/Time-of-Day Clock failed.
	Main Logic Board	Main Logic Board component failed.
	SIMM U0311	SIMM U0311 failed, bank 0.
	SIMM U0309	SIMM U0309 failed, bank 0.
	SIMM U0307	SIMM U0307 failed, bank 0.
	SIMM U0322	SIMM U0322 failed, bank 0.
		Reserved
		Reserved
		Reserved
		Reserved
		Reserved
		Reserved
		Reserved
		Reserved

Figure 2-3 Keyboard LED Diagnostic Codes

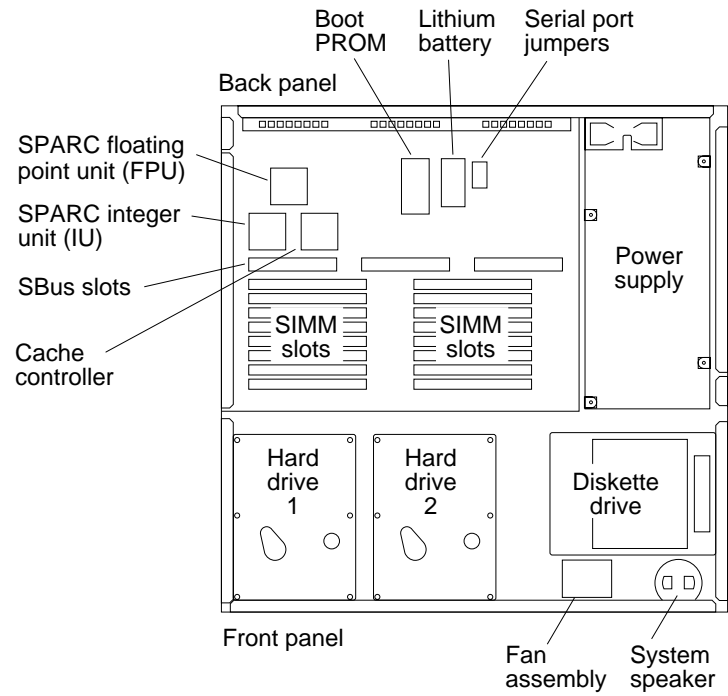

Figure 2-4 Location of SIMM Slots in System Unit

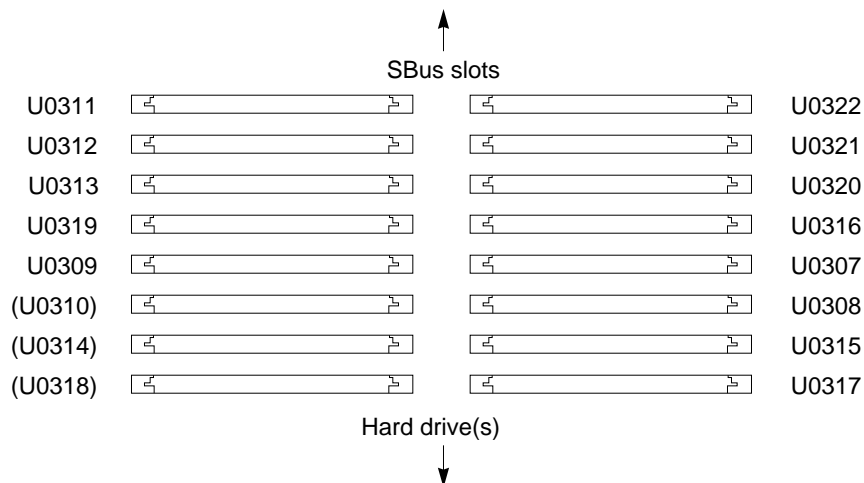

Figure 2-5 SIMM Slot Locations on Main Logic Board

Table 2-2 Table of Memory Banks

Bank:	Slots:	
0	U0311 U0309	U0322 U0307
1	U0312 (U0310)	U0321 U0308
2	U0313 (U0314)	U0320 U0315
3	U0319 (U0318)	U0316 U0317

Note – Slots U0310, U0314, and U0318 are *not* identified on the board with *any visible markings*. These slots are shown in Figure 2-5 and Table 2-2 in parentheses.

For further information about replacing the FRUs that fail, see “Removing and Replacing FRUs” in Chapter 4.

If all POST tests pass, run the SunDiagnostic Executive with the cache disabled. The SunDiagnostic Executive is an independent operating system. It runs exhaustive subsystem tests independent of SunOS. See the latest version of *SunDiagnostic Executive User's Guide for the SPARCstations*.

On-Board Diagnostics

You have access to a number of tests called On-board diagnostics. To invoke these tests, you must enter the Forth Toolkit.



Caution – In order to run On-board diagnostics, you must halt the system in an orderly manner. When the operating system or any other stand-alone program has already booted, do not use the **L1-A** keys to halt the system. Abruptly aborting program execution may cause damage to data files.

To run On-board diagnostics:

- 1. Save all your work and quit all applications.**
- 2. As root, halt the system by entering** `/usr/etc/fasthalt`.
You are presented with either the `>` prompt or the `ok` prompt. The `>` prompt is the default prompt. If you want to change the default prompt to the `ok` prompt, see the *Open Boot PROM 2.0 Toolkit User's Guide*.

If you see the `>` prompt, go to the next step. If you see the `ok` prompt, go to Step 4.
- 3. Enter `n` to enter the Forth Toolkit.**
The `ok` prompt shows that you are in the Forth Toolkit.
- 4. Enter `help diag` to get a listing of tests comprising on-board diagnostics.**

Figure 2-6 summarizes the steps you need to take to halt the system, enter the Forth Toolkit, and list the diagnostic tests.

```
hostname# /usr/etc/fasthalt
..... system messages are displayed
> n
ok help diag
Category: Diag (diagnostic routines)
test device-specifier ( -- ) run selftest method for specified device
Examples:
    test /memory      - test memory
    test /sbus/le     - test net
    test net          - test net (device-specifier is an alias)
    test floppy       - test floppy disk drive
watch-clock          (-- ) show ticks of real-time clock
probe-scsi           (-- ) show attached SCSI devices
```

Figure 2-6 Halting the System and Displaying On-Board Diagnostics

These on-board tests allow you to test the network controller, the diskette drive system, memory and the system clock. See “Diagnostic Routines” in the *Open Boot PROM 2.0 Toolkit User’s Guide* for a detailed description and step-by-step instructions of the available on-board diagnostic tests.

To return to the Monitor, > prompt, enter the following:

```
ok old-mode
>
```

Sundiag System Exerciser

The Sundiag System Exerciser, which runs under SunOS, displays real-time use of system resources and peripheral equipment such as Desktop Storage Packs and External Storage Modules. The Sundiag System Exerciser is run to verify that the system is functioning properly.

The exerciser is shipped with SunOS and preinstalled on SPARCstation 2. If it has been selected during the SunInstall (operating system loading) procedure, it can be run at any time and is found in the directory `/usr/diag/sundiag`. If the Sundiag System Exerciser is not found on the system hard disk or server,

you can load it from tape or CD. For information on how to use the Sundiag System Exerciser, see the *Sundiag User's Guide*. Appendix A, "Loopback Connectors" in the *Sundiag User's Guide* explains how to connect the external loopback connectors required for some options. If Sundiag passes, the system is operating properly. If Sundiag fails, the system is not operating properly. To identify the problem when Sundiag fails, first run the POST. If all POST tests pass, next run the SunDiagnostic Executive to isolate the problem.

SunDiagnostic Executive

The SunDiagnostic Executive is an independent operating system. It runs exhaustive subsystem tests independent of SunOS. Run the SunDiagnostic Executive if all POST tests pass in order to troubleshoot what field-replaceable unit needs to be replaced. For information on POST, see "Power-On Self-Test Detailed Description" earlier in this chapter. The SunDiagnostic Executive, which provides you with thorough diagnostics, is described in the *SunDiagnostic Executive User's Guide for the SPARCstations*.

Monitor and Forth Toolkit

The Monitor is a basic diagnostic utility. If there is any problem with your operating system, the Monitor automatically starts, indicated by the `>` prompt. You can also choose to enter the Monitor by halting the system. To enter the Forth Toolkit, indicated by the `ok` prompt, enter `n` from the `>` prompt.

The following procedure explains how to enter the Monitor and the Forth Toolkit:

1. Save all your work and quit all applications.

The following screen summarizes the steps you need to take to halt the system and enter the Forth Toolkit.

```
hostname# /usr/etc/fasthalt
syncing file systems .... done
Halted

Type b (boot), c (continue) or n (new command mode)
> n
```

2. As root, enter /usr/etc/fasthalt.

The system syncs the file systems and brings you to either the `>` or `ok` prompts. The `>` prompt is the default prompt. You will see the `ok` prompt if you reset the system parameters to have the `ok` prompt, the Forth Toolkit prompt, as the default prompt.

For Non-Volatile RAM system configuration parameters used during reset, see Appendix D. To have the `ok` prompt as the default, see the *Open Boot PROM 2.0 Toolkit User's Guide*. If you see the `ok` prompt, you are already in the Forth Toolkit and need to do nothing further. If you see the `>` prompt, go to the next step.

3. Enter `n` to enter the Forth Toolkit.

The `ok` prompt shows that you are in the Forth Toolkit.

For extensive information on tests you can run from the Forth Toolkit see Chapter 5 of the *Open Boot PROM 2.0 Toolkit User's Guide*.

To return to the Monitor `>` prompt, from the Forth Toolkit:

```
ok old-mode
>
```

Preparing to Work on the System



This chapter explains steps you must perform before replacing field-replaceable-units (FRUs). Topics covered in this chapter include the following:

- How to halt the system
- Tools needed
- How to disconnect the Desktop Storage Pack
- How to disconnect the External Storage Module
- How to remove the system unit's cover
- How to attach a wrist strap

Halting the System



Before you replace FRUs, you must halt the system in an orderly manner.

Caution – You must halt the system in an orderly manner. When the operating system or any other stand-alone program has already booted, do not use the **LT-A** keys to halt the system. Abruptly aborting program execution may cause damage to data files.

To halt the system:

1. Save any files you are presently editing. Quit from any applications that will lose information when the system halts.

See the *Sun System User's Guide* for more information about ending a work session.

2. Enter `/bin/su` to become superuser.

Additional information about the superuser command is described in Chapter 2 of the *Sun System & Network Manager's Guide*.

3. Enter the superuser password.

4. Enter `/usr/etc/halt`.

The system displays system halt messages followed by the Monitor prompt, `>`.

```
tutorial% /bin/su
Password:
tutorial# /usr/etc/halt
Syncing file systems... done
Halted

Type b (boot), c (continue), or n (new command mode)
>
```

5. Turn off the power in this order:

- External module (if you have one)
- System unit
- Monitor



Caution – Make sure your system is shut off. The green LED at the front of the system unit should not be lit, and the fans should not be running. Do not disconnect the power cord from the system unit's power outlet or the wall socket. This connection provides the ground path necessary to safely remove and install the printed circuit boards and components.

Margin note

On some keyboards, **L1** appears on the front face of the **stop** key. On a system that has a terminal as a console, rather than a Sun keyboard and bitmapped monitor, you must press **Break** instead of **L1-A** to obtain a boot prompt.

To halt a system that is hung, or frozen, and unresponsive to commands:

1. Press L1-A.

The system displays the system boot prompt.

2. Enter n.

The system displays a help message and an `ok` prompt.

3. Enter sync.

The system displays panic and boot messages. The `sync` command helps prevent the system from losing data that was not preserved when the system hung.

4. Wait until the system boots and displays a system login prompt.**5. Turn off the power in this order:**

- External drive unit (if you have one)
- System unit
- Monitor

The following example shows how to halt a hung system:

```
(Press L1-A.)
> n
Type help for more information
ok sync
(System panic and boot messages.)
tutorial login:
```

For additional information on the halt procedure see Chapter 1 of the *Sun System & Network Manager's Guide* and also the *System & Network Administration* manual.



Caution – Make sure your system is shut off. The green LED at the front of the system unit should not be lit, and the fans should not be running. Do not disconnect the power cord from the system unit's power outlet or the wall socket. This connection provides the ground path necessary to remove and install the printed circuit boards and component.

Tools Needed

To remove and replace FRUs, you will need the following tools and materials:

- Phillips screwdriver
- Flat blade screwdriver
- Wrist strap
- SIMM extractor
- Chip extractor
- Container for screws
- Anti-static mat for the SIMMs and the main logic board
- Nonconductive foam to store chips
- A Volt-Ohmmeter (VOM) for checking voltages and fuses

Disconnecting Desktop Storage Packs

If your system unit has Desktop Storage Packs connected to it, disconnect the Desktop Storage Packs' SCSI connector from the back of the system unit.

To disconnect the Desktop Storage Pack from the system unit:

- 1. Press in on the finger clips on the connector connecting the Desktop Storage Pack to the system unit and pull the connector off.**
This action disconnects the SCSI cable from the system unit.

Disconnecting External Storage Modules

If your system unit has External Storage Modules connected to it, disconnect the External Storage Modules' SCSI connector from the system unit.

To disconnect the External Storage Module (ESM) from the system unit:

- 1. Press in on the finger clips on the connector connecting the ESM to the system unit and pull the connector off.**
This action disconnects the SCSI cable from the system unit.

Removing the System Unit's Cover

Figure 3-1 shows how to remove the system unit's cover. Three tabs on the front of the cover fit into three slots in the chassis. These tabs secure the front of the cover to the chassis. A security loop secured to the cover goes through the bottom of the chassis.

To remove the cover and gain access to the FRUs inside the system unit:

1. Make sure that the power is turned off to your system unit, but that the power cord remains plugged in to the system unit and to the power source.

See "Halting the System" earlier in this chapter.

2. Remove the top cover from the system unit.

Do the following in sequence:

- Remove the two screws holding the cover to the back panel (see Figure 3-1).
- Grasp the sides of the cover from the rear and tilt the cover until the security loop clears the chassis (see Figure 3-2).
- Gently push the cover forward about 1/2 inch (13 mm) so that the plastic tabs clear the chassis.
- Remove the cover by lifting vertically.



Warning – Before powering up your system again, be sure to replace the top cover. See "Replacing the System Unit's Cover" towards the end of Chapter 4. It is not safe to operate the SPARCstation 2 without its top cover in place

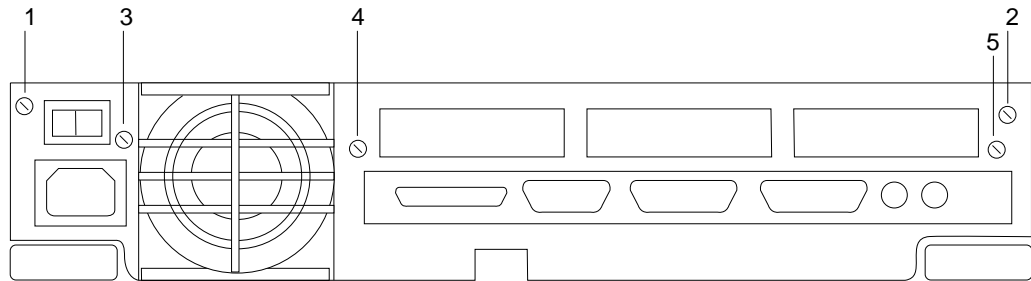

Note: There are five screws on the back panel. Remove screws 1 and 2. Do not remove screws 3, 4, and 5.

Figure 3-1 System Unit Back Panel

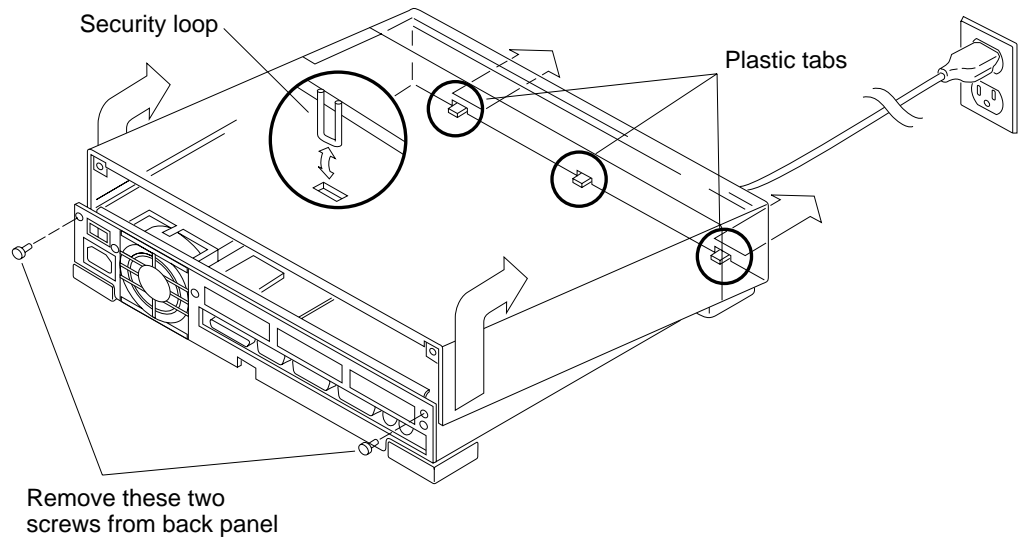

Figure 3-2 The System Unit's Cover

Attaching a Wrist Strap

The wrist strap is a device that provides grounding between your body and the system unit's chassis for static electricity. Electric current and voltage do not pass through the wrist strap. Attach the wrist strap to your wrist and to the system chassis. Parts that require the use of a wrist strap are packed with one.



Caution – Boards and modules can be damaged by harmful electrical charges if you do not wear a wrist strap

To attach the wrist strap:

- 1. Wrap the grounding strap with the conductive adhesive tape twice around your wrist.**

Make sure the adhesive side is against your skin.

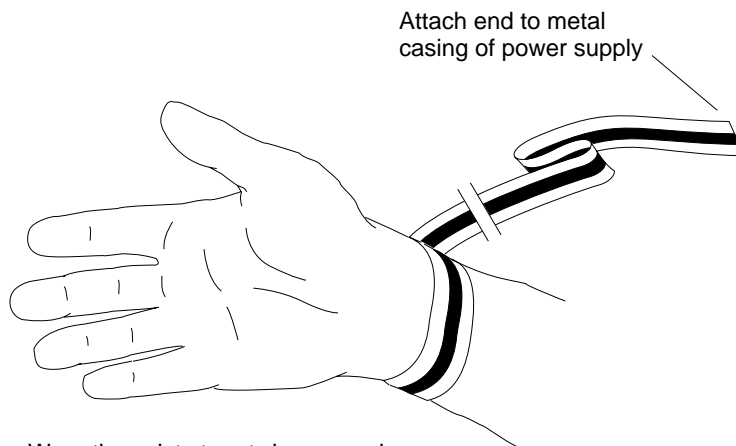

Wrap the wrist strap twice around your wrist (adhesive against your skin).

- 2. Attach the end with the adhesive copper strip to the metal casing of the power supply in the system unit.**

FRU Replacement



This chapter explains how to remove defective FRUs and replace new ones. See “FRU list” in Appendix C for the part numbers and description of FRUs. The following units are field-replaceable:

- Single Inline Memory Modules (SIMMs)
- SBus boards
- Power supply
- Hard disk drives
- Diskette drive
- Fan assembly
- Main logic board
- Boot PROM
- NVRAM/TOD clock
- System speaker
- Video monitors
- Mouse, mouse pad and cable
- Keyboard
- Cables

FRU replacement described in the manuals for the Desktop Storage Pack and the External Storage Module are not covered in this manual.

Before You Begin

Before you replace FRUs, make sure you have done the following:

- Halted your system
- Verified that you have the proper tools
- Removed the expansion units (if any)
- Removed the system unit's cover
- Attached a wrist strap

See Chapter 3 for further information.

Removing and Replacing FRUs

This section describes how to remove and replace FRUs. Please read through the entire set of instructions before removing and replacing a FRU.



Caution – Make sure your system is shut *off*. The green LED at the front of the system unit should not be lit, and the fans should not be running. Do not disconnect the power cord from the system unit's power outlet or from the wall socket. This connection provides the ground path necessary to safely remove and install the printed circuit boards and components.

FRU Identification

Before you attempt to replace or install a new board or module, make sure that you have the right unit. Figure 4-1 shows a top view of the system unit with the cover removed. Figure 4-2 shows some of the field-replaceable boards and the memory module. There are other field-replaceable boards that are available but not shown in Figure 4-2.



Caution – Printed circuit boards are made of delicate electronic components that are extremely sensitive to static electricity. Ordinary amounts of static from your clothes or work environment can destroy the boards.

Handle boards only by the non-conducting edges. Do not touch the components themselves or any metal parts. Wear a grounding strap when handling the boards.

Do not disconnect the power cord from the system unit's power outlet or from the wall socket. This connection provides the ground path necessary to safely remove and install the printed circuit boards and components.

Make sure that the system unit's power is turned off by checking to make sure that the green light-emitting diode (LED) at the front of the chassis is not lit and the fans are not running.

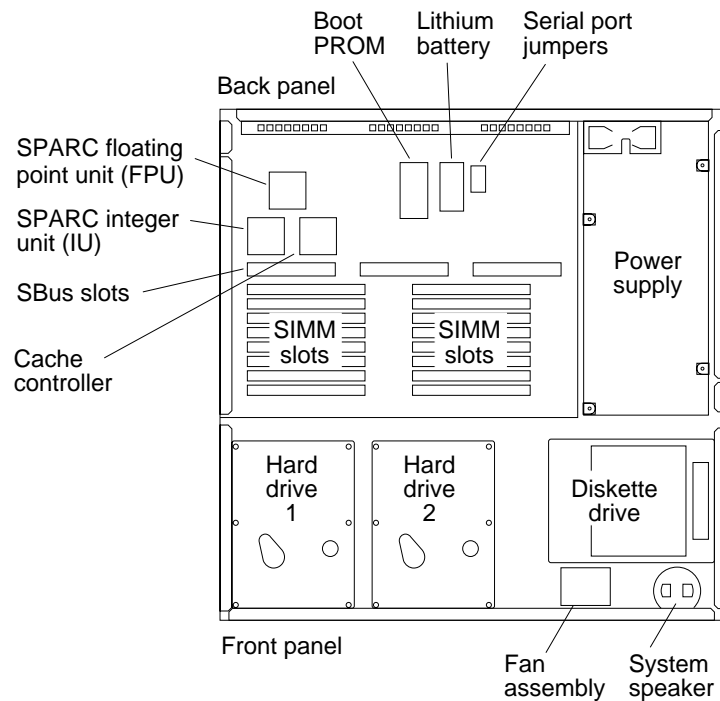
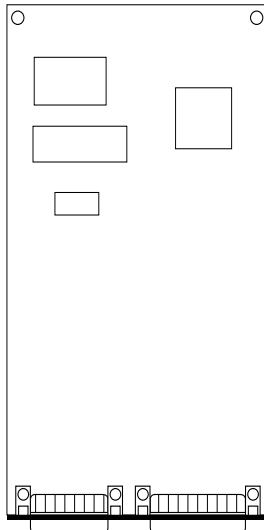
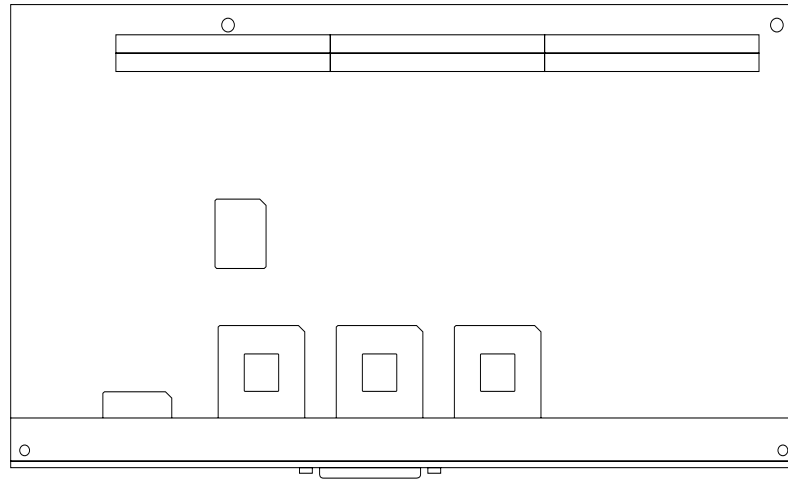

Figure 4-1 Top View of the System With the Cover Removed



SBus Printer Card



GS Graphics Accelerator Board

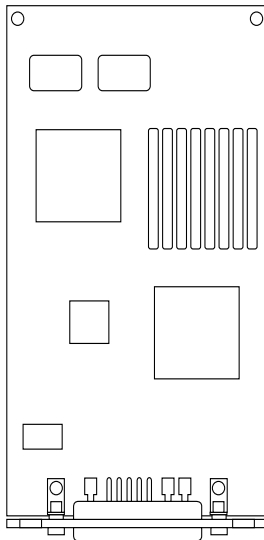

Color Frame Buffer Board

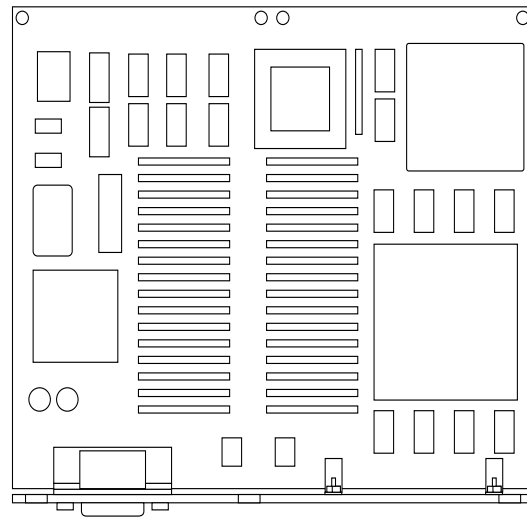

GX Graphics Accelerator Board

Figure 4-2 Boards and Modules (continued on next page)

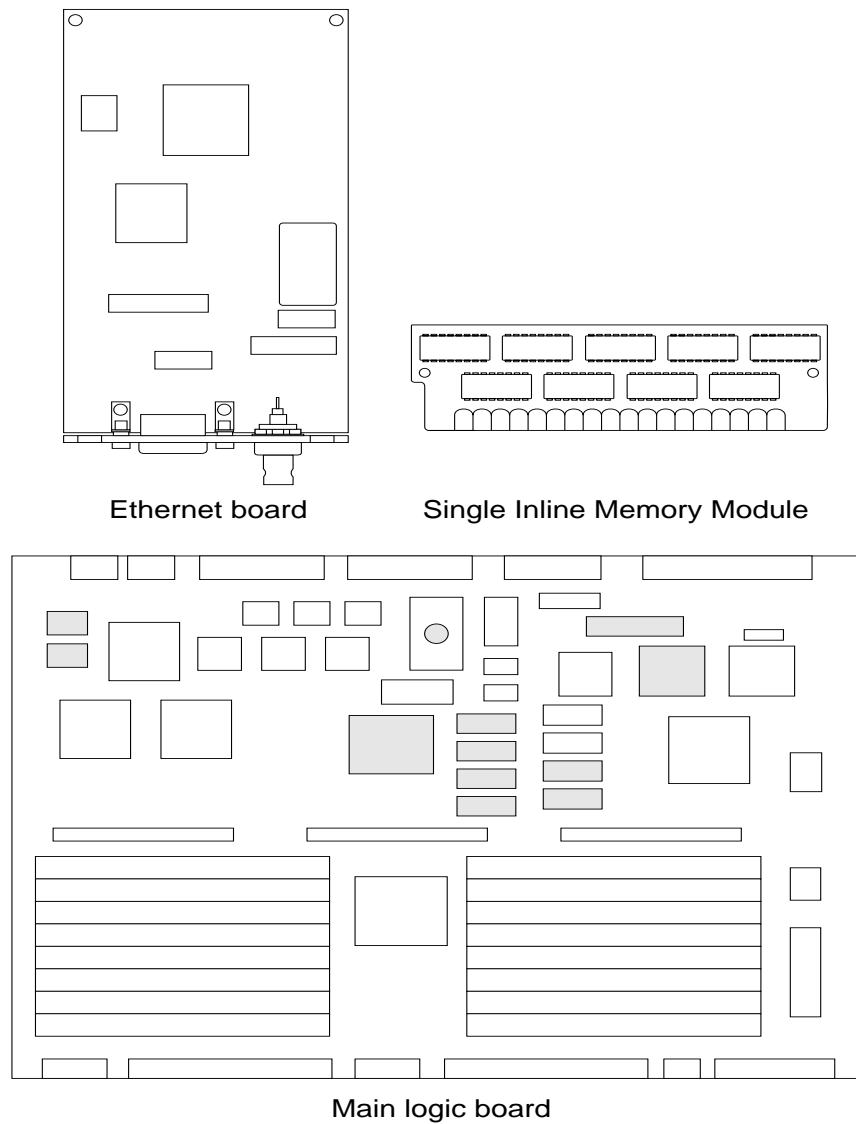

Figure 4-2 Boards and Modules (continued)

Single Inline Memory Modules (SIMMs)

SPARCstation 2 system units are equipped with a minimum of 16 megabytes of random access memory (RAM). Physically, RAM chips are grouped together in single inline memory modules (SIMMs). Each SIMM contains 4 megabytes of memory and plugs into a SIMM slot located on the main logic board of the system unit. Additional SIMMs may be added to the system unit as needed in 16-megabyte increments, up to a maximum of 16 SIMMs (64 megabytes).

Determining Faulty SIMM Locations

SunOS, Sundiag System Exerciser, SunDiagnostic Executive, and POST diagnostics can report memory errors encountered during program execution. Memory error messages on the system monitor display usually include a physical memory address of the error.

Depending on the diagnostic program you are running and the SunOS release loaded, a SIMM location number (“U” number) may be displayed. If the location number is present in the error message, follow the instructions later in this chapter for removing the defective SIMM at that location and installing a replacement (see Figure 4-7 for SIMM location numbers).

If the location number is not displayed but a physical memory address is shown, refer to the following table to locate the SIMM bank in which the defective SIMM is installed.

Bank	Physical Address Range	Byte	(Bits)	SIMM
0	000000-fffff	0	31-24	U0311
		1	23-16	U0309
		2	15-8	U0307
		3	7-0	U0322
1	1000000-1fffff	0	31-24	U0312
		1	23-16	(U0310)
		2	15-8	U0308
		3	7-0	U0321
2	2000000-2fffff	0	31-24	U0313
		1	23-16	(U0314)
		2	15-8	U0315
		3	7-0	U0320
3	3000000-3fffff	0	31-24	U0319
		1	23-16	(U318)
		2	15-8	U0317
		3	7-0	U0316

Bits	Bits	Bits	Bits
31.....24	23.....16	15.....8	7.....0
Byte 0	Byte 1	Byte 2	Byte 3

For example, if an error is detected at physical memory address 12fe958, the defective SIMM is located in bank 1. If you also know the failing byte at that address, the table shows the “U” number location of the failing SIMM. Follow the instructions later in this chapter for removing the defective SIMM at that location and installing a replacement (see Figure 4-7 for SIMM location numbers).



Caution – SIMMs are made of delicate electronic components that are extremely sensitive to static electricity. Ordinary amounts of static from your clothes or work environment can destroy the modules.

Handle boards only by the edges. Do not touch components themselves or any metal parts. Always wear a grounding strap when handling the modules.

Do not disconnect the power cord from the system unit's power outlet or from the wall socket. This connection provides the ground path necessary to safely remove and install the modules.

Make sure that the system unit's power is turned *off* by checking to make sure that the green light-emitting diode (LED) at the front of the chassis is not lit and that the fans are not running.

Note – Bank 0 must be filled with SIMMs or the system will not pass its power-on self test.

To remove a SIMM, follow these steps:

1. **Read the parts of Chapter 3 about how to halt your system, tools needed, removing expansion units, attaching a wrist strap, and removing the system unit's cover.**
2. **Check that the green LED at the front of the chassis is not lit.**
3. **Check that the fans are not running.**
4. **Check that the system's power cord remains connected to the system and the wall outlet.**
5. **Locate the SIMM slots on the main logic board. The SIMM components must be facing toward you (see Figures 4-6 and 4-7).**

Note – Slots U0310, U0314, and U0318 are *not* identified on the board with *any visible markings*.

6. **Insert the hooked end of the extraction tool (see Figure 4-3) into the left or right SIMM extraction hole.**

Use the hole that allows rotation of the tool to the left or right without encountering obstructions (see Figure 4-4)

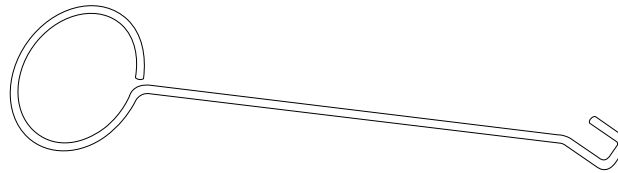

Figure 4-3 SIMM Extraction Tool

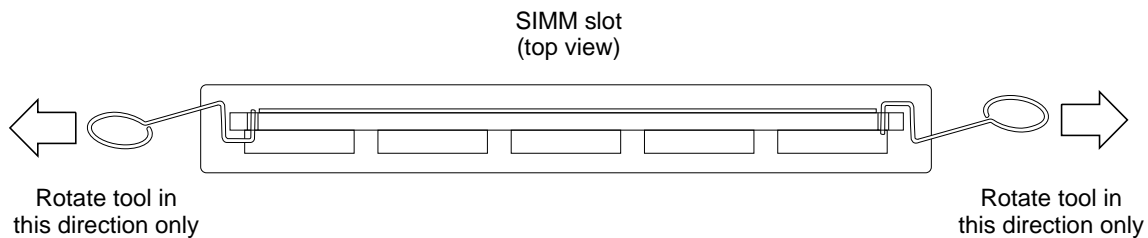

Figure 4-4 Inserting the SIMM Extraction Tool

7. **Rotate the tool in a *sideways* motion, prying the side of the SIMM upward.**
8. **You will hear a click when the SIMM has disengaged from the slot.**
9. **With the tool still in the hole, continue to lift the side of the SIMM until the edge clears the slot.**
10. **Remove the tool.**
11. **Grasp the SIMM by the left and right edges and continue to lift straight up until the module is free of the slot.**
Take note of the slot numbers you are extracting the SIMMs from. See Figure 4-5 for final removal of a SIMM.

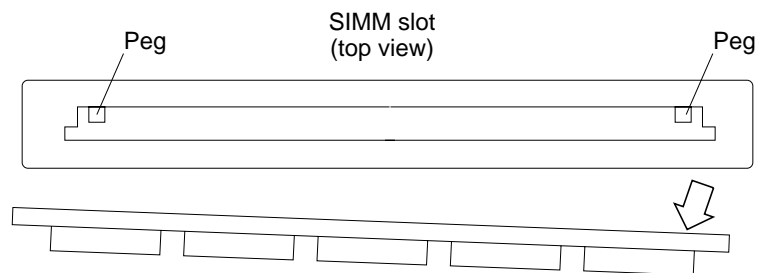

Figure 4-5 Final Manual Removal of a SIMM

To install a SIMM, follow these steps:

If you have removed a SIMM because it was defective, install the replacement SIMM into the same slot from which the defective one was removed. You must install the SIMMs in unoccupied slots so that the slots are filled by banks.

For example, you have removed the SIMM from slot U0320 from bank 2. You need to replace the SIMM in slot U0320 from bank 2 so that all slots in bank 2 are filled. There should be SIMMs in slot U0313, U0314, and U0315 to begin with, so all four slots in bank 2 are filled. Table 4-1 identifies memory banks and slots.



Caution – SIMMs are made of delicate electronic components that are extremely sensitive to static electricity. Ordinary amounts of static from your clothes or work environment can destroy the modules.

Do not remove the SIMMs from the anti-static container until told to do so. Handle the modules only by the edges. Do not touch components themselves or any metal parts. Always wear a grounding strap when handling the modules.

1. Read the parts of Chapter 3 about how to halt your system, tools needed, removing expansion units, attaching a wrist strap, and removing the system unit's cover.
2. Check that the green LED at the front of the chassis is not lit.
3. Check that the fans are not running.
4. Check that the system's power cord remains connected to the system and the wall outlet.
5. Locate the SIMM slots on the main logic board (see Figures 4-6 and 4-7).

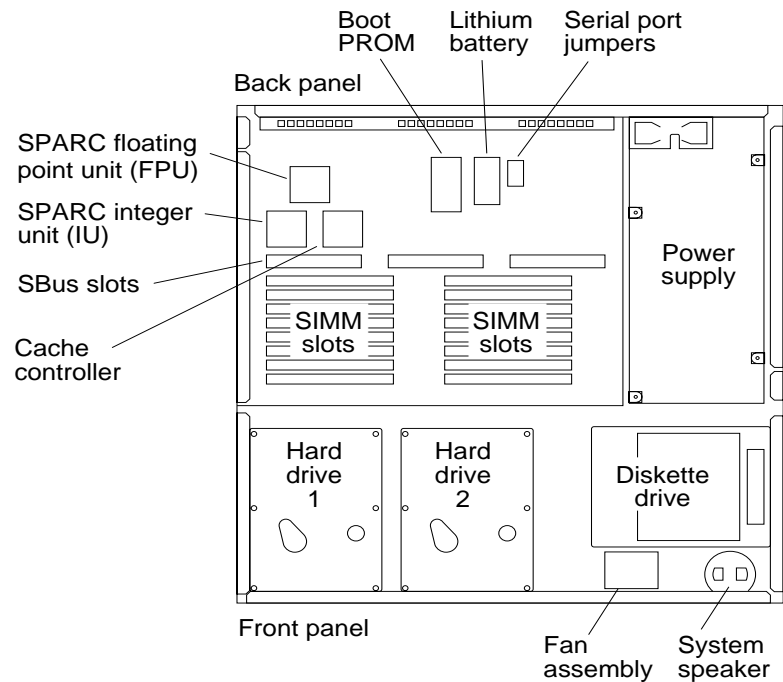

Figure 4-6 Location of SIMM Slots in System Unit

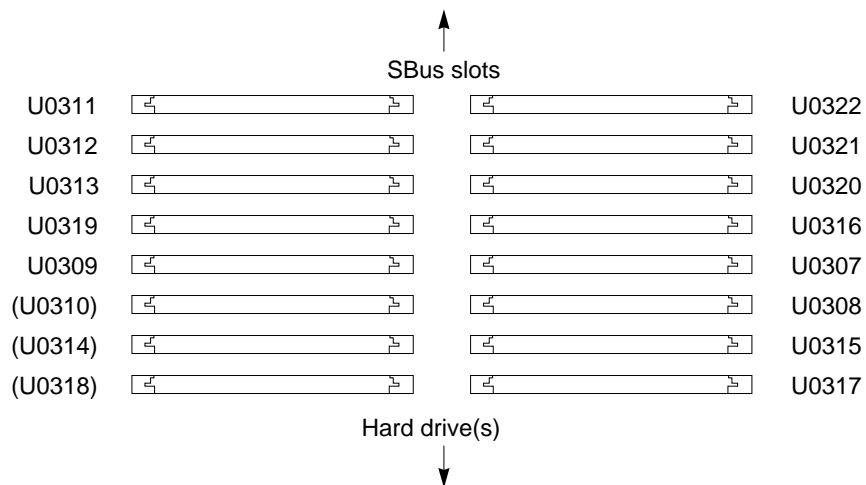

Figure 4-7 SIMM Slot Location on Main Logic Board

Table 4-1 Table of Memory Banks

Bank:	Slots:	
0	U0311 U0309	U0322 U0307
1	U0312 (U0310)	U0321 U0308
2	U0313 (U0314)	U0320 U0315
3	U0319 (U0318)	U0316 U0317

Note: Slots U0310, U0314, and U0318 are *not* identified on the board with any visible markings. These slots are shown in Figure 4-7 and Table 4-1 in parentheses.

6. **Place an anti-static mat shiny side up, next to the system unit.**
The mat comes with your SIMMs.
7. **Make sure the wrist strap is securely attached to your wrist and the metal casing of the power supply.**
8. **See Chapter 3 for instructions on how to attach a wrist strap.**
9. **Open the anti-static container and take out the SIMMs.**
10. **Place the SIMMs on the anti-static mat.** Figure 4-8 shows typical SIMM.

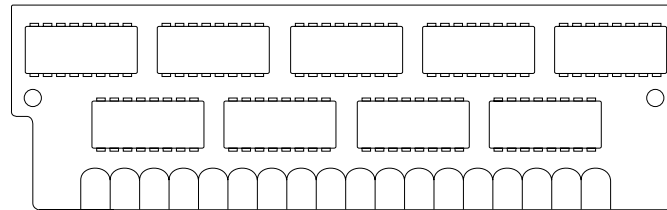
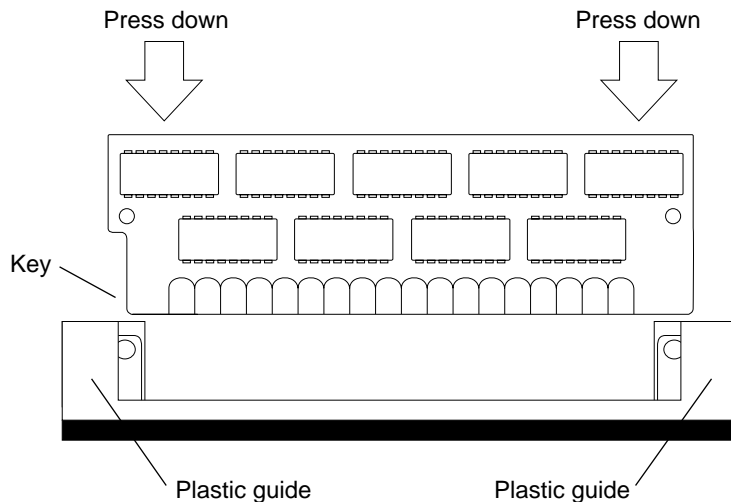

Figure 4-8 4 Megabyte SIMM: Horizontally-mounted Chips

11. **Holding a SIMM at its edges, insert it into the plastic guides by pushing straight down.**
The SIMM should rest loosely in the slot. The SIMMs are keyed to allow installation in only one direction. When a SIMM is properly installed, its component side must face the back panel.

- 12. Place your thumbs on opposite corners of the SIMM and press firmly until the SIMM snaps into place.**



- 13. Replace the system unit's top cover.**
See "Replacing the System Unit's Cover" near the end of this chapter.
- 14. Turn the system unit's power on, and check for proper operation of the system unit and the installed SIMMs.**
See "How to Turn the Power Back On" at the end of this chapter.

SBus Boards

The system can be equipped with a variety of optional printed circuit boards. The following are examples of the boards that plug into the SBus slots on the system's main logic board. This list is not necessarily inclusive.

- **GX Graphics Accelerator Board**
This board controls the video output from the system unit, and accelerates the generation of graphic images. The GX Graphics Accelerator board occupies two SBus slots on the main logic board.
- **Color Frame Buffer Board**
This board occupies one SBus slot. This board controls the video output from the system unit to a color monitor.

- **Second Ethernet Board**
This board provides you with an extra Ethernet port. The Ethernet board is used in applications in which your SPARCstation 2 acts as a gateway between two physically distinct Ethernet networks. This board has two connectors: standard (thick) Ethernet and thin Ethernet, and occupies one SBus slot.
- **GS Graphics Accelerator Board**
This option consists of two boards that are plugged to each other on their component sides. They are triple-wide SBus boards and occupy three SBus slots. Figure 4-2 shows the top side of GS Graphics Accelerator Board when it is installed in the system unit. This option provides 24-bit color and 3 dimensional graphics capabilities. It also requires a 76 Hz color monitor.
- **Video Frame Capture Board**
This board occupies one SBus slot. This board takes video input and displays it on color or monochrome monitors.
- **SBus Printer Card**
This board occupies one SBus slot. This board allows the connection of the SBus to printing, plotting and scanning devices.
- **1-Bit Analog Frame Buffer Board**
This board occupies one SBus slot. It controls the video output from the system to a monochrome monitor.

If you have removed an SBus board because it was defective, replace SBus board into the same slot(s) from which the defective one was removed. For information on installing the SBus board, see the manual included with it.

To remove an SBus board from the system unit:

- 1. Read the parts of Chapter 3 about how to halt your system, tools needed, removing expansion units, attaching a wrist strap, and removing the system unit's cover.**
- 2. Check that the green LED at the front of the chassis is not lit.**
- 3. Check that the fans are not running.**
- 4. Check that the system's power cord remains connected to the system and the wall outlet.**

5. Locate the SBus board you want to remove.

6. Remove the external connectors attached to the SBus board.

Put your index fingers or thumbs underneath the corners of the SBus board where it is plugged into the slot. Pull up on the board



Caution – The plastic SBus retainer is *not* a handle. Pulling on the SBus board retainer can cause it to break.

This action releases the SBus board from the SBus slot

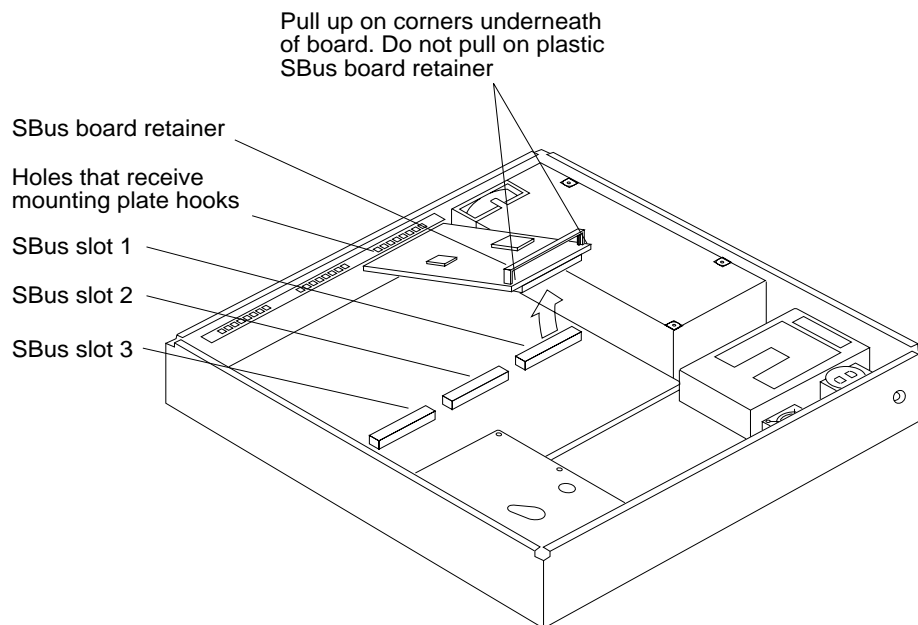

To replace an SBus board in the system unit:

1. Slide the SBus board at an angle into the back panel of the system unit (see the following figure).

Make sure that the mounting plate on the SBus board hooks upward into the holes at the back panel of the system unit.

Margin note The mounting slots are above the rectangular opening for the connector in the back panel.



Caution – When replacing the SBus board, do not press down on the SBus board retainer. The SBus board retainer is not a handle. Pressing down on it may break the retainer.

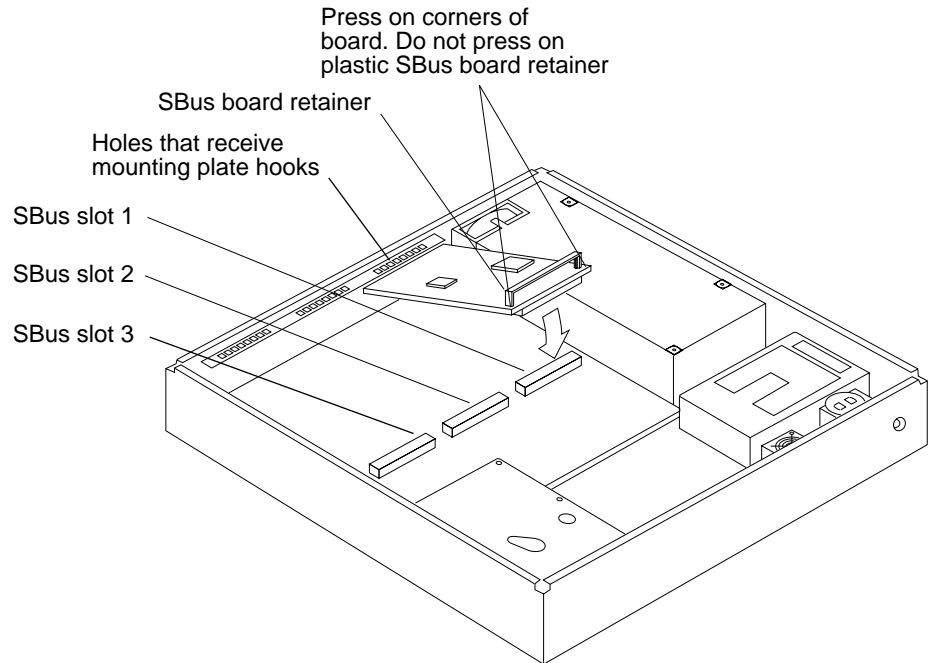

2. Push the SBus board against the back panel.

Align the plug with the socket of the SBus slot and gently press the plug into the socket by pressing with your fingers on the corners of the SBus board.



Caution – Using excessive force may bend or damage the pins.

3. Replace the top cover of the system unit.

To do this, see “Replacing the System Unit’s Cover” near the end of this chapter.

4. Replace the external cables to the SBus boards.

5. **Turn the system unit's power on, and check for proper operation of the system unit and the replaced SBus board.**

See "How to Turn the Power Back On" at the end of this chapter.

Power Supply

The power supply is a self-contained metal assembly located just behind the diskette drive (see Figure 4-9). The recess in the bottom of the chassis is for the fan that is built into the power supply.

The power supply is held in place by two guides in the bottom of the chassis, two tabs that mate with two slots in the bottom of the power supply, and a screw. The screw is inserted through the rear bezel of the system unit.

A 12-pin power cable connects the power supply to the main logic board just behind the power cable connector for the diskette drive.



Warning – Make sure that the system unit is *unplugged* from the AC power outlet and the power switch is in the *off* position before you remove, replace, or install the power supply in the system unit. Failure to take this precaution may result in severe electrical shock.

To remove the power supply follow these steps:

1. **Read the parts of Chapter 3 about how to halt your system, tools needed, removing expansion units, attaching a wrist strap, and removing the system unit's cover.**
2. **Check that the green LED at the front of the chassis is not lit.**
3. **Check that the fans are not running.**
4. **Remove the power cord from the system unit.**
5. **Remove the screw from the back panel (Figure 4-9).**
6. **Disconnect the cable from the white 12-pin connector (J0701) on the main logic board.**
7. **Grasp the power supply.**
Slide it forward toward the front of the chassis and lift it out of the chassis.

To replace a new power supply follow these steps:

- 1. Align the new power supply correctly as shown in Figure 4-9 with the tabs and guides in the bottom of the chassis.**
- 2. Position the power supply by pushing it firmly toward the rear of the chassis until it locks into the tabs.**
- 3. Connect the power cable to the white 12-pin connector (J0701) on the main logic board.**
The connector is keyed so that the power cable will fit only one way (see Figure 4-9).
- 4. Secure the power supply to the chassis by installing the screw through the rear panel of the chassis (see Figure 4-9).**
- 5. Replace the system unit's top cover.**
See "Replacing the System Unit's Cover" near the end of this chapter.
- 6. Connect the power cord to the system unit.**
- 7. Turn the system unit's power on, and check for proper operation of the system unit and the newly replaced power supply.**
See "How to Turn the Power Back On" towards the end of this chapter.

If the newly replaced power supply still does not work properly, a problem exists in the system unit, such as a blown component or a short circuit. Refer to the section "Before Replacing the main Logic Board" later in this document for power supply voltage measurement procedures.

Note – Make sure the power supply is connected to the main logic board before making any voltage measurements.

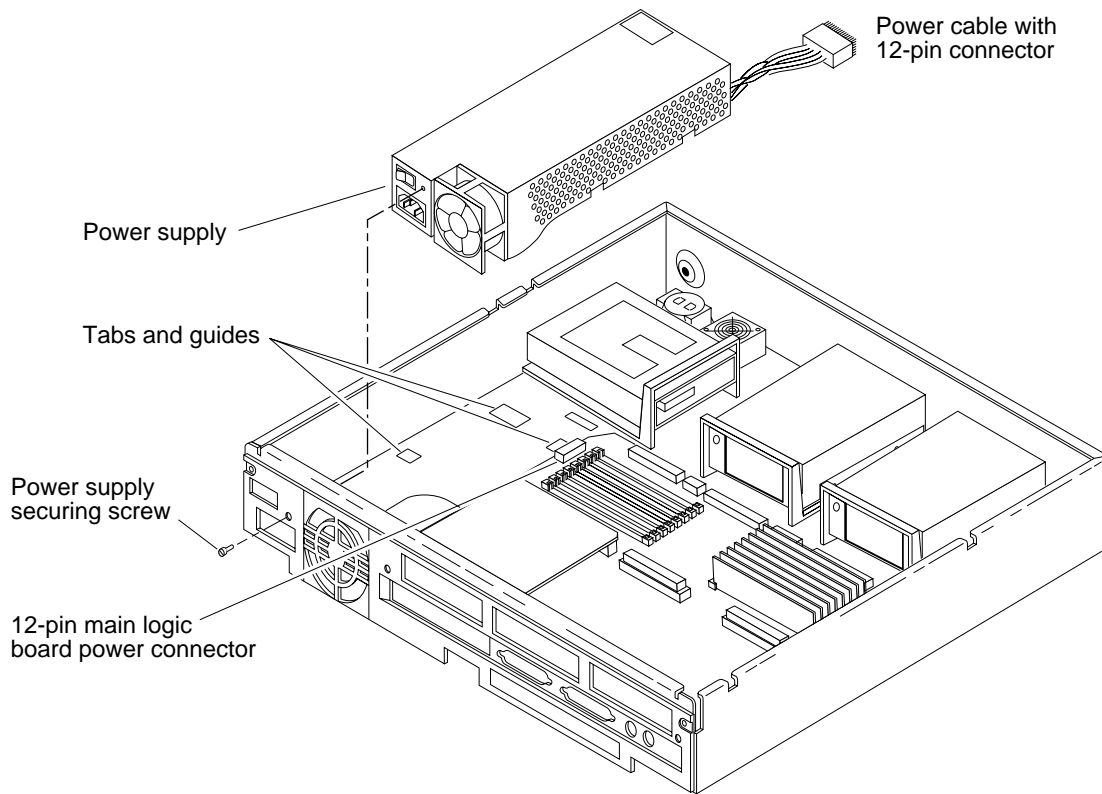

Figure 4-9 Removing and Replacing the Power Supply

Hard Disk Drive

Two 3 1/2-inch half-height hard disk drives can be installed in the system chassis. A 50-pin SCSI data cable and a 4-pin power cable connect to the rear of each drive. Each drive and its plastic mounting bracket are secured to the chassis by four mounting tabs and two locking tabs that fit into slots in the bottom of the chassis.



Caution – The hard disk drive contains electronic components that are extremely sensitive to static electricity. Ordinary amounts of static from your clothes or work environment can destroy the components.

Do not touch the components themselves or any metal parts. Wear a grounding strap when handling the drive. See “Attaching a Wrist Strap” in Chapter 3.

Do not disconnect the power cord from the system unit’s power outlet or from the wall outlet. This connection provides the ground path necessary to safely remove and install the hard disk drive.

Make sure that the system unit’s power is turned *off* by checking to make sure that the green light-emitting diode (LED) at the front of the chassis is not lit and that the fans are not running.

To remove a hard disk drive:

- 1. Read the parts of Chapter 3 about how to halt your system, tools needed, removing expansion units, attaching a wrist strap, and removing the system unit’s cover.**
- 2. Check that the green LED at the front of the chassis is not lit.**
- 3. Check that the fans are not running.**
- 4. Check that the system’s power cord remains connected to the system and the wall outlet.**
- 5. Disconnect the hard disk drive power and data cables from the main logic board (see Figure 4-14).**
- 6. Grasp the hard disk drive mounting bracket handle (see Figure 4-14). Pull it up slightly to release the locking tabs on the bottom of the mounting bracket.**
- 7. Slide the hard disk drive toward the rear of the chassis. Lift the hard disk drive out of the chassis.**

This completes the hard disk drive removal process.

To prepare a hard disk drive for replacement:

Before replacing a hard disk drive, you must verify that the SCSI drive address ID is installed correctly (see Table 4-2).

The SCSI device ID of drive 1 must be 3. The SCSI device ID of drive 2 must be 1 (see Table 4-2). The factory setting for all replacement hard disk drives is SCSI device ID 3.

Table 4-2 Table of Hard Disk ID Jumper Settings

Drive Number	SCSI Device ID	Jumper Setting
1 See Figure 4-15	3	See Figures 4-10 and 4-11
2 See Figure 4-15	1	See Figures 4-12 and 4-13

Depending on the replacement drive available, the jumpers are located either near the lower right corner of the drive controller board, or near the lower left corner.

Note – The markings for the jumpers on the drive shown in Figures 4-10 and 4-12 are etched or labeled onto the drive's controller board. The jumpers on the drive shown in Figures 4-11 and 4-13 are not marked on the drive's controller board.

1. Remove the four screws from the bracket and remove the bracket from the drive.

Set the old drive aside on the static mat.

2. Remove the replacement drive from its protective packaging and set it with the component side up on the antistatic mat.

You now have access to the drive controller board.

Go to the next step if you are replacing drive 1. Go to step 4 if you are replacing drive 2.

3. Inspect the jumper settings. Compare them to the settings shown in Figure 4-10 or 4-12.

- If the settings are the same as in the figure that matches your drive, leave them as they are.
- If the settings are *not* the same, change them to match the settings in the figure.

Go to step 5.

4. Inspect the jumper settings. Compare them to the settings shown in Figure 4-11 or 4-13.

- If the settings are the same as in the figure that matches your drive, leave them as they are.
- If the settings are *not* the same, change them to match the settings in the figure.

5. Replace the mounting bracket on the new drive.

Fasten the bracket to the drive by inserting and tightening the four screws through the bottom of the bracket into the bottom of the drive.

6. Remove the power and data cables from the old drive and connect them to the replacement drive.

The power and data cables are keyed so they will fit only one way.

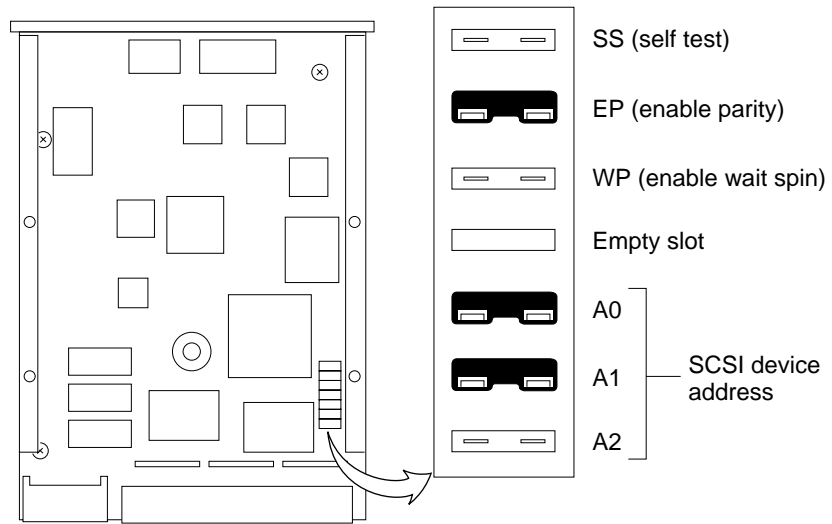

Figure 4-10 Hard Disk Drive with 6 Jumpers—Jumper Setting for Drive 1

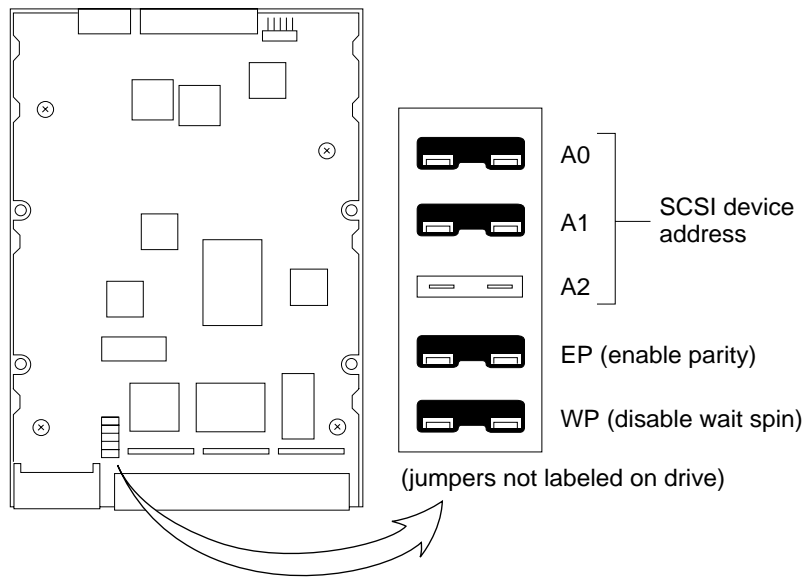

Figure 4-11 Hard Disk Drive with 5 Jumpers—Jumper Setting for Drive 1

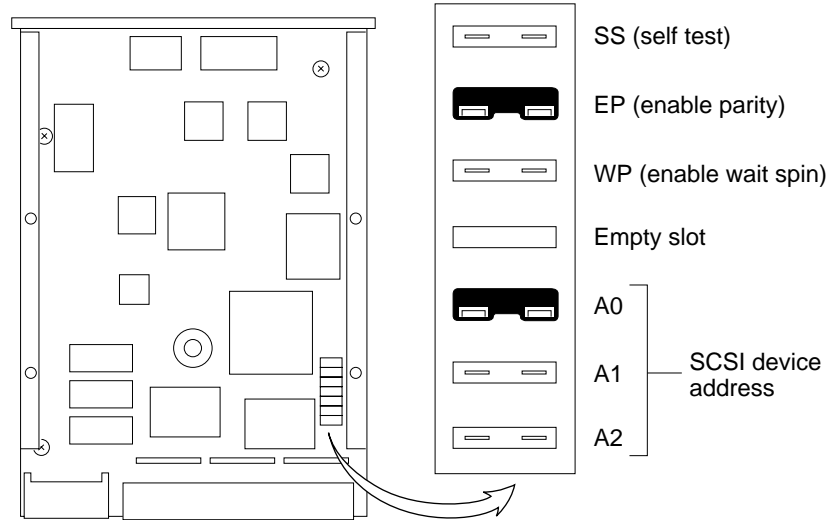

Figure 4-12 Hard Disk Drive with 6 Jumpers—Jumper Setting for Drive 2

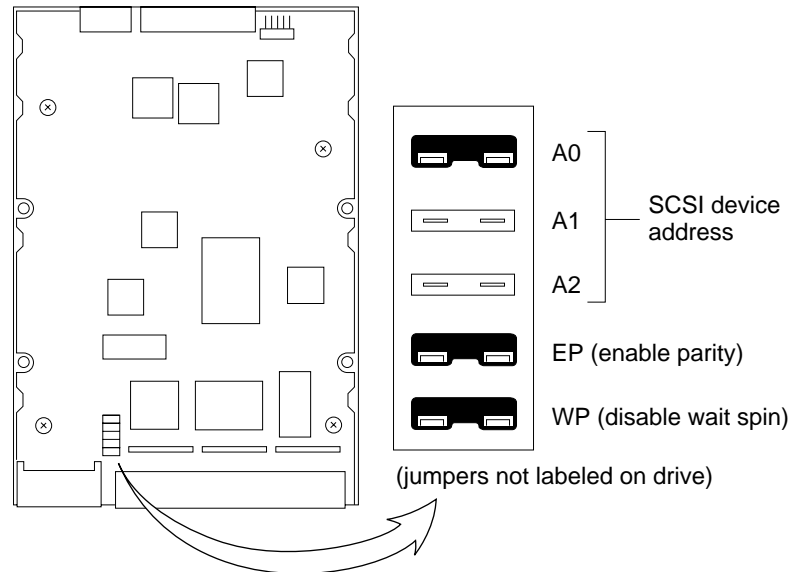

Figure 4-13 Hard Disk Drive with 5 Jumpers—Jumper Setting for Drive 2

To replace a hard disk drive:

- 1. Make sure you have followed the previous procedure on preparing the hard disk drive for replacement.**
- 2. Lower the drive into the chassis and align the four mounting tabs on the bottom of the drive mounting bracket with the slots in the bottom of the chassis (see Figure 4-14).**

The drive unit's data and power cables should be facing the rear of the chassis. Slide the drive forward toward the front of the chassis until the two rear locking tabs click into their slots.
- 3. Connect the data and power cables to the main logic board (see Figure 4-15).**
- 4. The data cable plugs into the data connector on the main logic board.**

The data cable is keyed so that it will fit only one way.
- 5. The power cable plugs into the power connector on the main logic board.**

The power connector is keyed so that it will fit only one way.
- 6. Replace the system unit's top cover.**

See "Replacing the System Unit's Cover" near the end of this chapter.
- 7. Turn the system unit's power on, and check for proper operation of the system unit and the replaced hard disk drives.**

See "How to Turn the Power Back On" towards the end of this chapter.

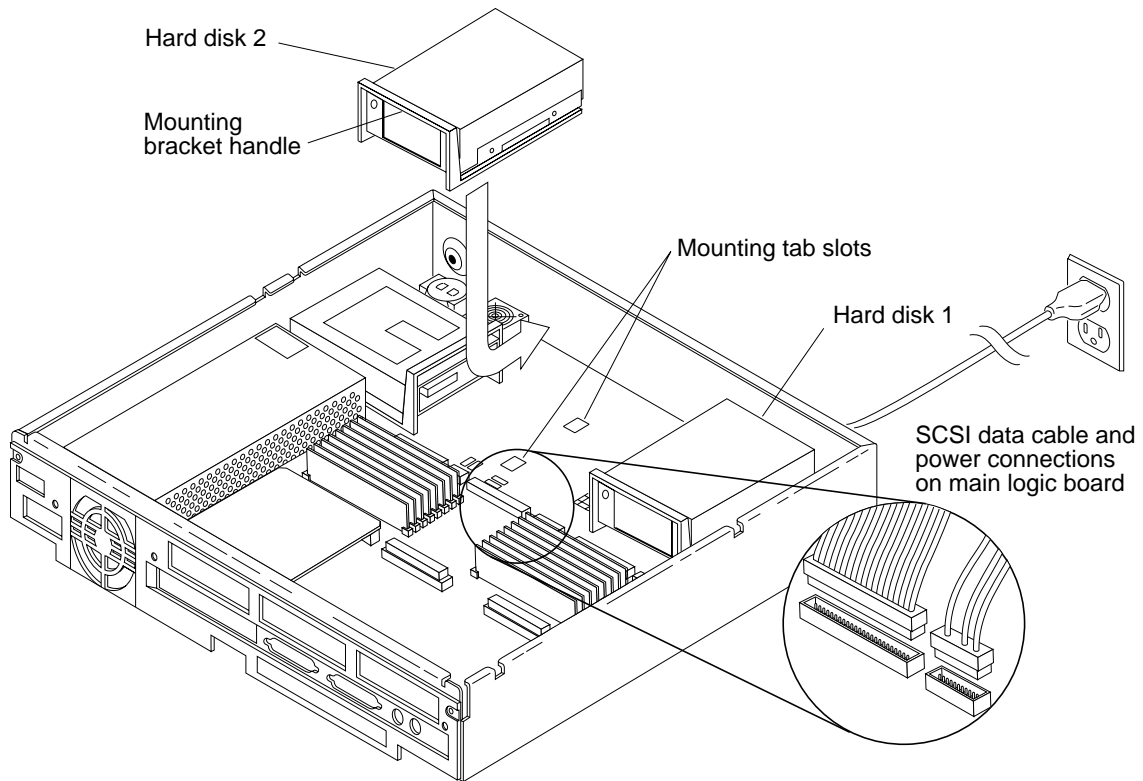

Figure 4-14 Removing and Replacing the Hard Disk Drive.

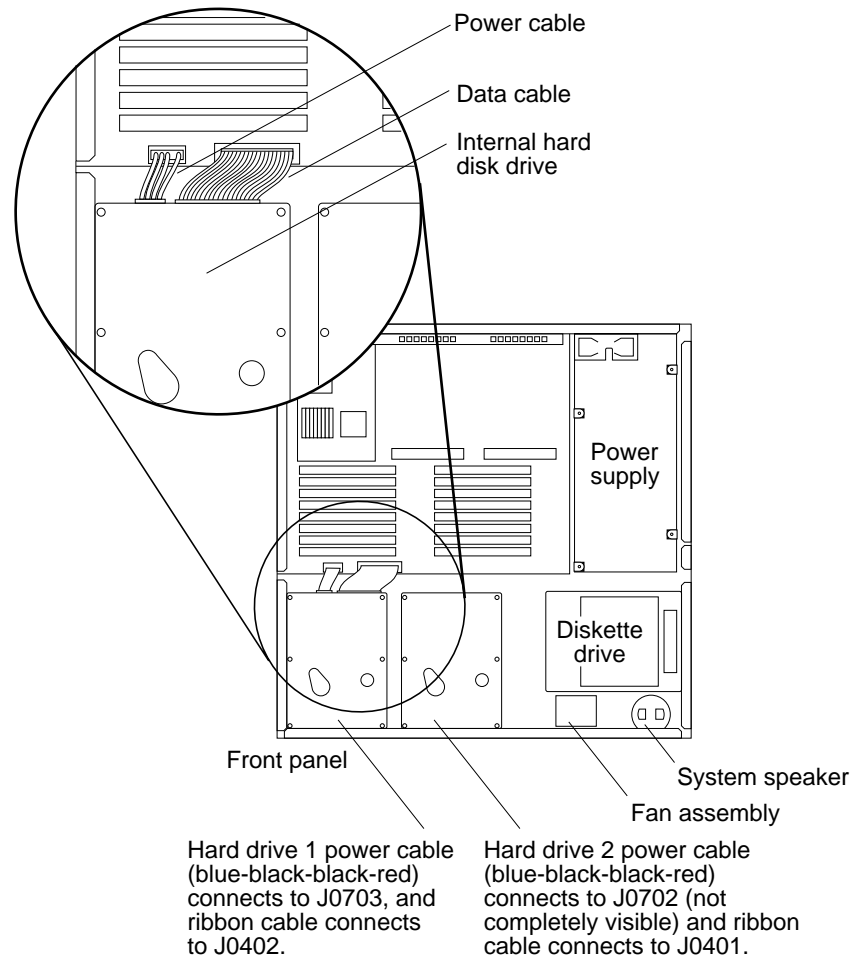

Figure 4-15 Connecting Power and Data Cables to the Hard Disk Drive

Diskette Drive

The diskette drive is located at the front right side of the chassis next to the hard disk drives (see Figures 4-1 and 4-16). A 34-pin data cable and a 4-pin power cable connect to the rear of the drive. The drive and its mounting bracket are secured to the chassis by four mounting tabs and two locking tabs that fit into slots in the bottom of the chassis.



Caution – The diskette drive contains electronic components that are extremely sensitive to static electricity. Ordinary amounts of static from your clothes or work environment can destroy the components.

Do not touch the components themselves or any metal parts. Wear a grounding strap when handling the drive. See “Attaching a Wrist Strap” in Chapter 3.

Do not disconnect the power cord from the system unit’s power outlet or from the wall socket. This connection provides the ground path necessary to safely remove and install the diskette drive.

Make sure that the system unit’s power is turned *off* by checking that the green light-emitting diode (LED) at the front of the chassis is not lit and the fans are not running.

To remove the diskette drive:

- 1. Read the parts of Chapter 3 about how to halt your system, tools needed, removing expansion units, attaching a wrist strap, and removing the system unit’s cover.**
- 2. Check that the green LED at the front of the chassis is not lit.**
- 3. Check that the fans are not running.**
- 4. Check that the system’s power cord remains connected to the system and the wall outlet.**
- 5. Disconnect the diskette drive’s data cable from the main logic board.**
- 6. Disconnect the "Y" power cable from the main logic board and the fan assembly (see Figure 4-17).**
- 7. Grasp the diskette drive mounting bracket handle (see Figure 4-16).**
Pull it up slightly to release the locking tabs on the bottom of the mounting bracket.
- 8. Slide the diskette drive toward the center of the chassis.**
Lift the diskette drive out of the chassis. This completes the diskette drive removal process.

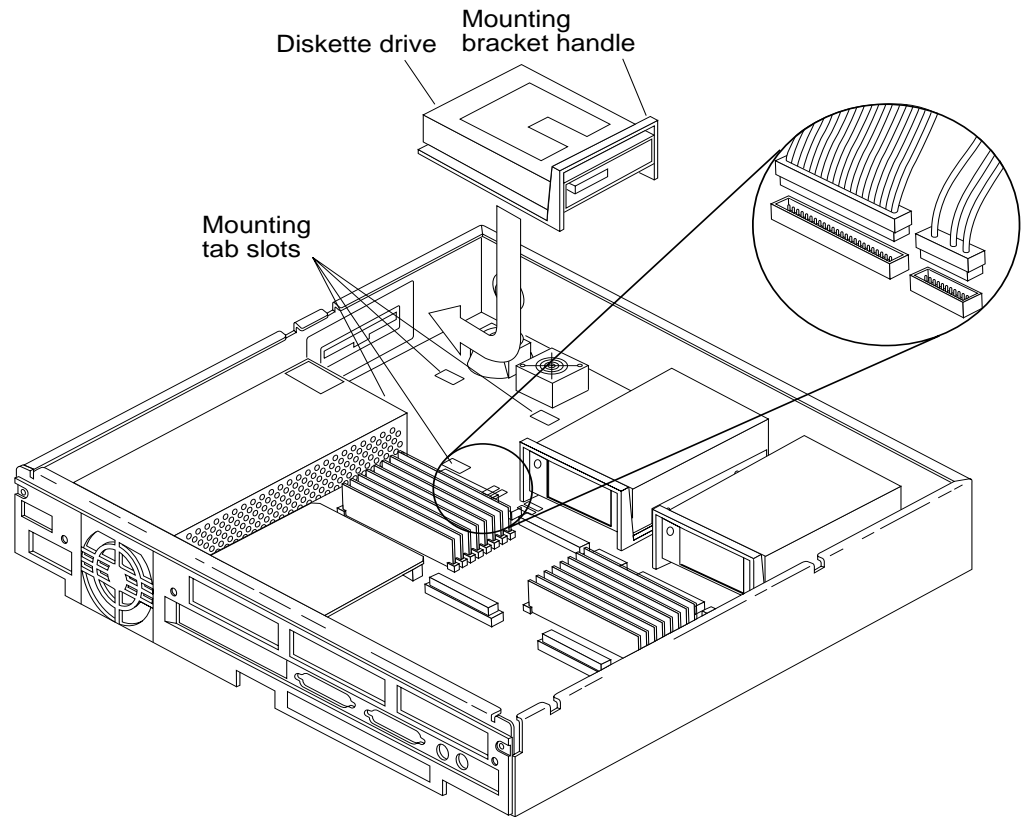

Figure 4-16 Removing and Replacing the Diskette Drive

To prepare a diskette for replacement:

- 1. Remove the mounting bracket from the drive.**
Turn the drive over and remove the four screws securing the bracket to the bottom of the drive.
- 2. Disconnect the data and "Y" power cable from the drive (see Figure 4-17).**
- 3. Remove the replacement drive from its protective packaging.**
- 4. Install the mounting bracket on the replacement drive.**
Fasten the bracket to the bottom of the hard drive by inserting and tightening the four screws through the bracket.

- 5. Connect the data and "Y" power cables to the replacement drive (see Figure 4-17).**

The power and data connector are keyed so they will fit only one way.

To replace the diskette drive:

- 1. Align the four mounting tabs on the bottom of the drive mounting bracket with the slots in the bottom of the chassis (see Figure 4-16).**
- 2. Slide the drive forward towards the outside of the chassis until the two locking tabs click into their slots.**
- 3. Connect the data and "Y" power cables to the main logic board (see Figure 4-17).**
- 4. The data and power connectors plug into the data and power connectors on the main logic board.**
The connectors are keyed so that each will fit only one way.
- 5. Connect the "Y" power cable to the fan assembly (see Figure 4-17).**
- 6. Replace the system unit's top cover.**
See "Replacing the System Unit's Cover" near the end of in this chapter.
- 7. Turn the system unit's power on, and check for proper operation of the system unit and the replaced diskette drive.**
See "How to Turn the Power Back On" at the end of this chapter.

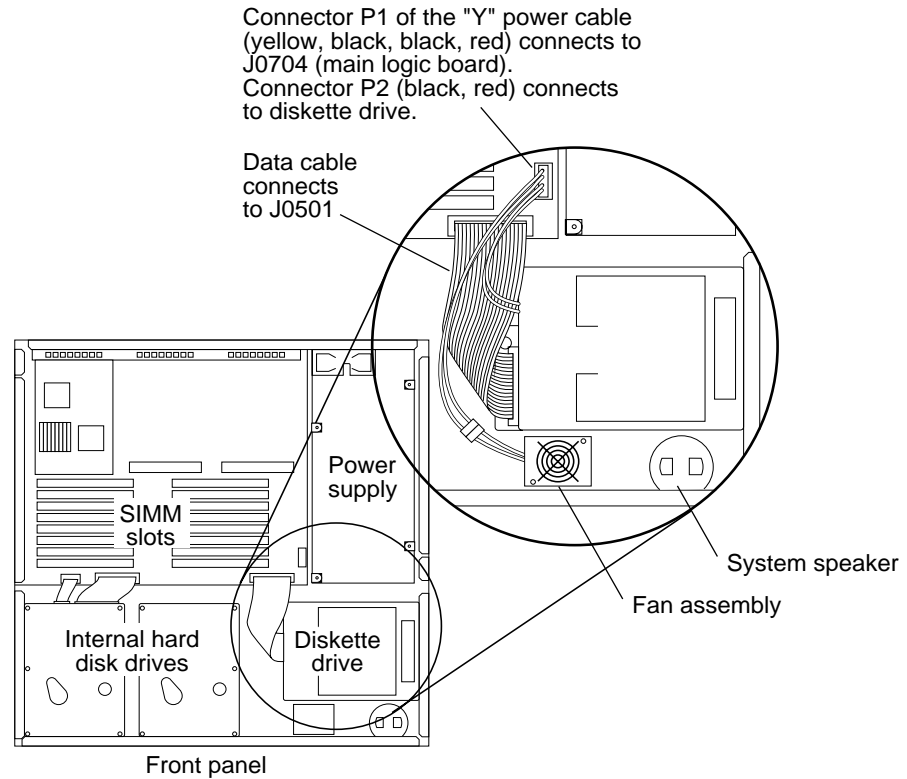

Figure 4-17 Connecting Power and Data Cables to the Diskette Drive

Fan Assembly

Each SPARCstation 2 contains two fan assemblies. One of them is built into the power supply. Although the power supply is a field replaceable-unit, the fan assembly resides in the power supply itself is not a field replaceable-unit. See "Power Supply" earlier in this Chapter. The other fan assembly is located at the front right side of the chassis, next to the diskette drive and the system speaker (see Figure 4-18). This fan assembly is a field replaceable unit.

To remove the fan assembly:

- 1. Read the parts of Chapter 3 about how to halt your system, tools needed, removing expansion units, attaching a wrist strap, and removing the system unit's cover.**
- 2. Check that the green LED at the front of the chassis is not lit.**
- 3. Check that the fans are not running.**
- 4. Check that the system's power cord remains connected to the system and the wall outlet.**
- 5. Disconnect the fan cable from the 2-pin connector of "Y" power cable (Figure 4-19).**
- 6. Remove both screws from the fan assembly (Figure 4-18).**
- 7. Remove the fingerguard (Figure 4-18).**
- 8. Grasp and lift the fan assembly out of the chassis.**

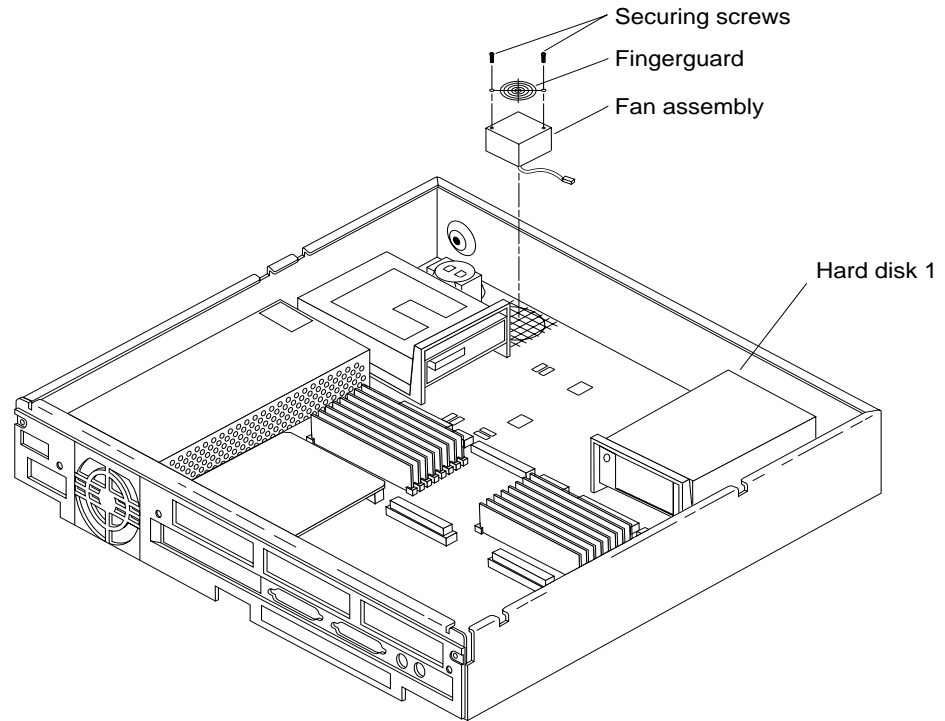

Figure 4-18 Removing and Replacing the Fan Assembly

To replace the fan assembly:

- 1. Align the replacement fan assembly such that the mounting holes on the fan and the chassis are lined up.**
The locator on the chassis makes sure that the fan is oriented the correct way (Figure 4-18).
- 2. Connect the fan cable to the 2-pin connector of "Y" power cable (Figure 4-19).**
- 3. Place the fingerguard on top of the fan assembly.**
- 4. Install both screws through the fingerguard, fan assembly and the chassis (Figure 4-18).**
- 5. Replace the system units's top cover.**
See "Replacing the System Unit's Cover" near the end of this chapter.

6. Turn the system unit's power back on, and check for proper operation of the system unit and the newly installed fan assembly.

See “How to Turn the Power Back On” towards the end of this chapter.

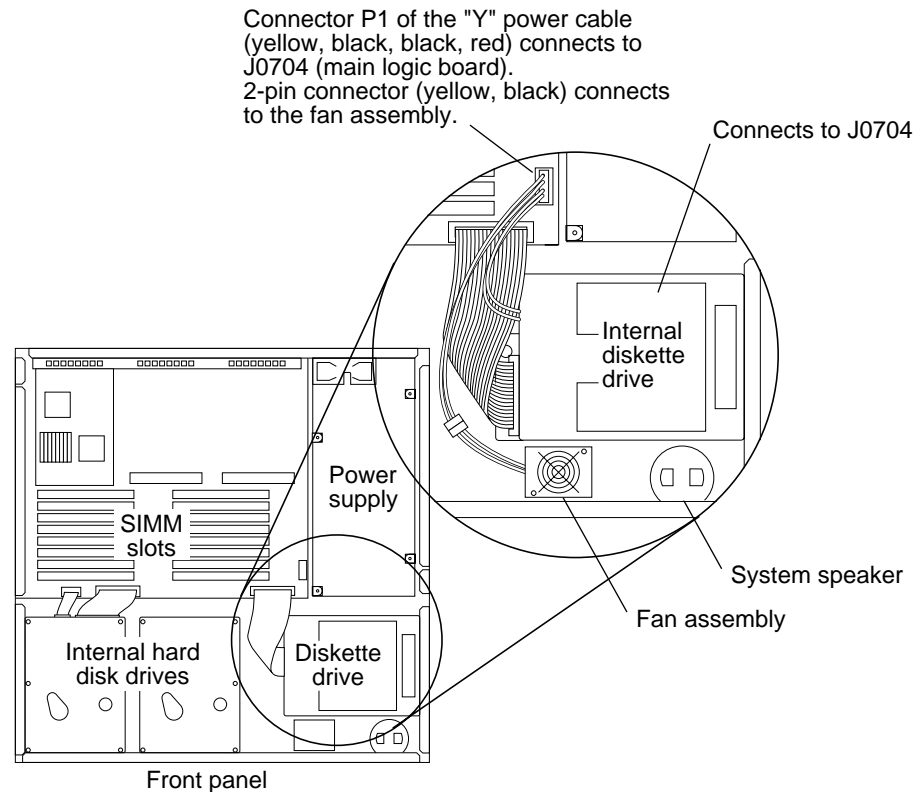

Figure 4-19 Connecting "Y" Power Cable to Fan Assembly.

Main Logic Board

The main logic board contains the CPU, the floating point coprocessor, the boot PROM, the NVRAM, SIMMs, SBus boards, two RS-423/232 ports, an Ethernet port, a SCSI port, and connectors for audio input/output, and keyboard/mouse as well as many other ICs (see Figures 4-20 and 4-21). See Chapter 1 for an overview of the main logic board.

In addition, a 12-pin plug connects to the power supply cable to provide power to the board and the disk drives. The 34-line diskette drive data and power cables connect to the main logic board just in front of the white 12-pin connector plug. The 50-line SCSI data cables and the hard disk drive power cables connect along the front of the main logic board to the left of the speaker and diskette data cable connections.

Serial Port Jumpers

There are two serial port jumpers on the main logic board (see Figures 4-20 and 4-21). The jumpers are preset from the factory in RS-423 mode. The ports can be set either as RS-232 mode (for users in the Federal Republic of Germany) or as RS-423 mode for the rest of the users. See *SPARCstation 2 Installation Guide* for more information on serial port mode jumpers.

To change the serial port jumpers on the main logic board to RS-232 mode:

- 1. Read the parts of Chapter 3 about how to halt your system, tools needed, removing expansion units, removing the system unit's cover and attaching a wrist strap.**
- 2. Check that the green LED at the front of the chassis is not lit.**
- 3. Check that the fans are not running.**
- 4. Check that the system's power cord remains connected to the system and the wall outlet.**
- 5. Locate the jumper blocks on the main logic board near the lithium battery.** See Figures 4-20, 4-21, 4-22 and 4-23.

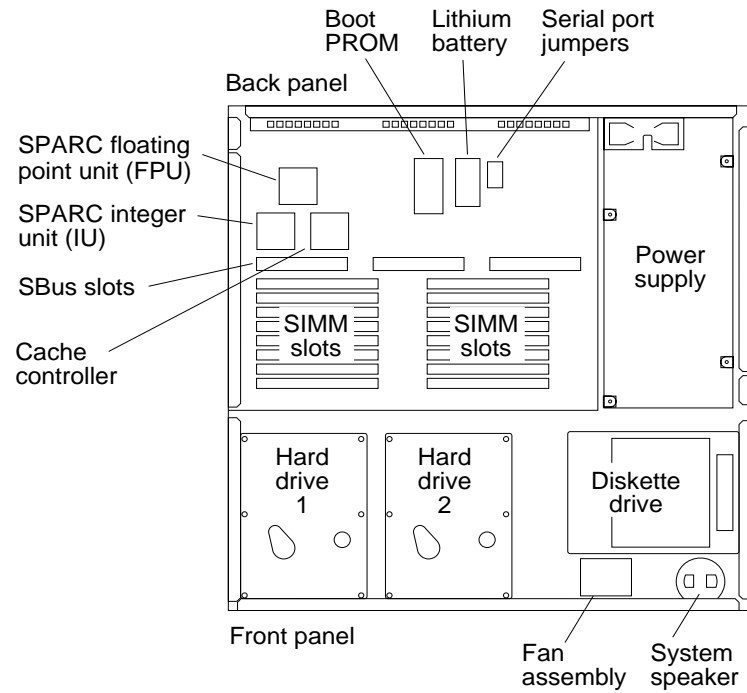

Figure 4-20 Top View of System Unit's Internal Parts

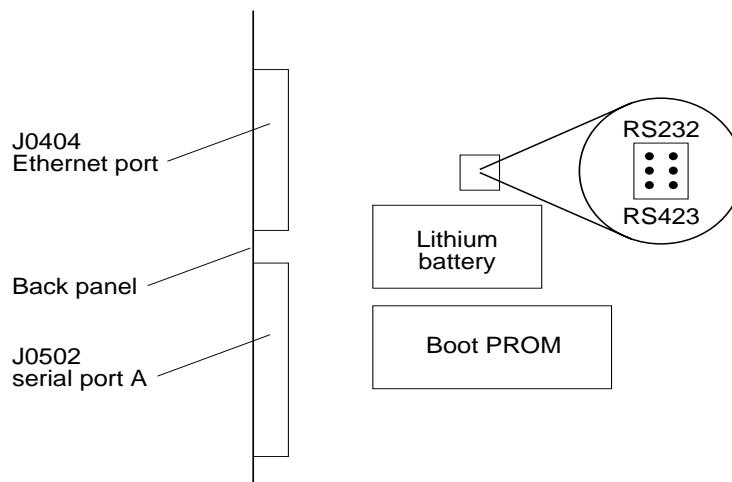

Figure 4-21 Serial Port Jumpers

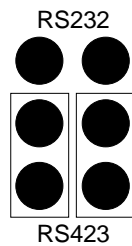

Figure 4-22 Preset RS-423 Jumper Positions

6. Use a pair of needlenose pliers and move *both* jumpers from the RS-423 positions to the RS-232 positions.

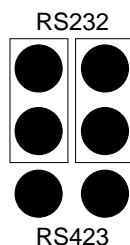

Figure 4-23 RS-232 Jumper Positions

7. Replace the top cover of the system unit.

To do this, see “Replacing the System Unit’s Cover” near the end of this chapter.

8. Turn the power of the system unit on, and check for proper operation of the system unit.

See “How to turn the Power Back On” towards the end of this chapter.

Main Logic Board Voltage Test Points

There are no voltage test points on the main logic board. If you need to measure DC voltages, use the pins on the 12-pin power supply connector (J0701) located on the main logic board (Figure 4-25). The pins with red wires are +5 V, the blue wires are +12 V, the brown wire is -12 V, and the black wires are GROUND. See Figure 4-24 for pin locations if the wire colors described here do not match the connector.

The acceptable range for +5 V voltage is +4.90 V to +5.10 V. The acceptable range for +12 V is +11.6 V to +12.84 V. The allowable range for -12 V is -11.6 V to -13.2 V with an internal disk drive installed, or -10.2 V to -13.8 V without an internal drive.

+5V	7	1	+5V
+5V	8	2	+5V
GND	9	3	GND
GND	10	4	GND
+12V	11	5	+12V
-12V	12	6	Power On Reset

Figure 4-24 Pin Location of Power Supply Connector (J0701)

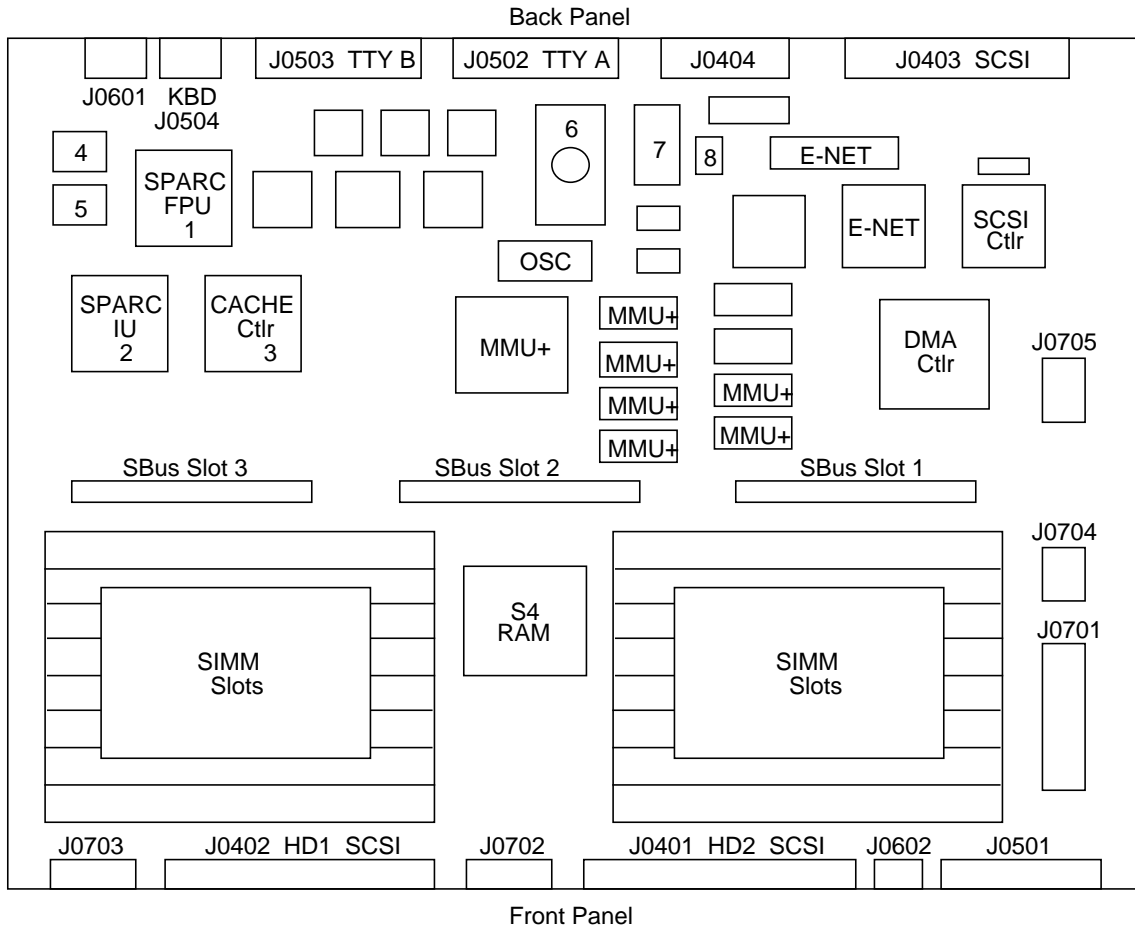

Figure 4-25 Main Logic Board Layout

Table 4-3 Main Logic Board Parts layout: Legend

Figure 4-25	Definition
1	SPARC Floating Point Unit
2	SPARC Integer Unit
3	Cache Controller
4	Cache Data RAM (chip set)
5	Cache Data RAM (chip set)
6	Boot PROM
7	NVRAM, Time-of-Day Clock, Lithium Battery
8	RS-232 and RS-423 serial port mode jumpers
DMA CTRL	DMA Controller, S4 DMA+
E-NET	Ethernet Controller (chip set)
MMU+	Memory Management Unit+ (chip set)
OSC	Oscillator
RAM CTRL	RAM Controller, S4 RAM
SCSI Ctrl	SCSI Controller
SIMM	Single Inline Memory Module
J0401	Hard Drive 2 SCSI cable connector
J0402	Hard Drive 1 SCSI cable connector
J0403	SCSI port
J0404	Ehternet port
J0501	Diskette Drive data cable connector
J0502	Serial Port A
J0503	Serial Port B
J0504	Keyboard cable connector
J0601	Audio Input/Output cable connector
J0602	System Speaker and LED connector
J0701	Power Supply connector
J0702	Hard Drive 2 power connector
J0703	Hard Drive 1 power connector
J0704	Diskette drive power connector
J0705	Memory/SBus expansion connector

Table 4-4 List of Acronyms

Acronyms	Full Expression
DMA	Direct Memory Access
MMU+	Memory Management Unit+
NVRAM	Non-Volatile Random Access Memory
PROM	Programmable Read-Only Memory
RAM	Random Access Memory
SCSI	Small Computer System Interface
SIMM	Single Inline Memory Module



Caution – Printed circuit boards are made of delicate electronic components that are extremely sensitive to static electricity. Ordinary amounts of static from your clothes or work environment can destroy the boards.

Handle boards only by the non-conducting edges. Do not touch components themselves or any metal parts. Always wear a grounding strap when handling the boards.

Do not disconnect the power cord from the system unit's power outlet. This connection provides the ground path necessary to safely remove and install the boards.

Make sure that the system unit's power is turned *off* by checking to make sure that the green light-emitting diode (LED) at the front of the chassis is not lit and that the fans are not running.

Before Replacing the Main Logic Board

This section explains with steps to perform before removing and replacing the main logic board. Removing and replacing the main logic board is a drastic step to take. Therefore, it is important to try to troubleshoot all other possibilities before removing and replacing the main logic board.

To check for and eliminate other possible problems before you replace the main logic board:

1. **Read the parts of Chapter 3 about how to halt your system, tools needed, removing expansion units, removing the system unit's cover and attaching a wrist strap.**
2. **Check that the green LED at the front of the chassis is not lit.**
3. **Check that the fans are not running.**
4. **Check that the system's power cord remains connected to the system and the wall outlet.**
5. **Connect a terminal to the system unit.**
For details, see the *SPARCstation 2 Installation Guide*.
6. **This enables you to view output of the POST test results as they are run.**
7. **Disconnect the graphics monitor and the Ethernet connectors.**
8. **Remove the SBus boards from the system.**
To do this see "SBus Boards" earlier in this chapter.
9. **Unplug the hard disk drives and the diskette drive from their data and power cables.**
See Figures 4-17 and 4-19 in this chapter for the location of the data and power cables.
10. **Make sure all SIMMs are correctly seated (see Figures 4-6 and 4-7 for the location of the SIMM slots), all cables attached, and all chips on the main logic board correctly seated in their sockets.**

Note – Bank 0 must be filled with SIMMs or the system will not pass its power-on self test.

11. **Turn the system power on.**
12. **Measure the power supply voltages with a VOM (Figure 4-26).**



Caution – Measuring voltages without connecting the DC cable to the main logic board will result in inaccurate readings. Without load, the power supply will not regulate.

The wire colors are the following:

Red	+5 V
Blue	+12 V
Brown	-12 V
Gray	Por (Power On Reset from the power supply)
Black	Ground

Note – The Por Signal is a TTL open collector and pull up is on the main logic board.

The limits for the voltages are:

+5 V	4.90 V to 5.10 V
+12 V	11.16 V to 12.84 V
-12 V	-11.16 V to -13.20 V with an internal drive
-12 V	-10.20 V to -13.80 V without an internal drive

Do the following in sequence:

- Turn the power off and connect the hard disk drive and diskette drive power and data cables.
- Turn the power on and again measure the power supply voltages. If the voltages are correct, you have ruled out that the power supply is defective. Go to step 12. If any of the voltages are incorrect, follow the next step.
- Disconnect each drive separately until the correct voltages are measured. Replace the drive that is holding the voltage down.
- With the power off, install the SBus boards that were removed earlier. Turn on the power and measure the power supply voltages.
- If any voltages are incorrect after installing the SBus boards, remove the boards until the voltages are correct and replace the bad board. If the voltages are correct, you have ruled out that the power supply is defective.

13. Replace the system unit's cover.

To do this see “Replacing the System Unit's Cover” towards the end of this chapter.

14. Turn on the system and the terminal.

The system will start to boot. To interrupt the boot sequence, press **L1-A** on the system keyboard.

The default prompt is the `>` prompt. You can reset the default prompt to be the `ok` prompt. To make the default prompt the `ok` prompt, see the *Open Boot PROM 2.0 Toolkit User's Guide*.

If you see the `ok` prompt, go to step 15. If you see the `>` prompt, go to the next step.

15. At the `>` prompt, enter `n`.**16. This enters the Forth Toolkit and displays its `ok` prompt.****17. Use the commands shown below to set the diagnostic switch to true, set the autoboot switch to false, and reset the system.**

```
ok setenv diag-switch? true
ok setenv auto-boot? false
ok reset                the system is rebooted and POST is run
```

As POST tests run, view the results on the keyboard LEDs located on the upper right corner of your keyboard. Figure 2-4 shows the meaning of the LED display pattern.

18. If all POST tests pass, go to the next step.

If one or more of the following POST tests fails, take one of the following actions:

- If the PROM fails, replace the boot PROM. See “Boot PROM” later in this chapter.
- If you replace the Boot PROM and re-run the POST and the PROM test fails again, a component between the CPU and the boot PROM on the main logic board is defective. Reinstall the original boot PROM. See “Boot PROM” later in this chapter. Remove and replace the main logic board. See “Removing the Main Logic Board” and “Replacing the Main Logic Board” later in this chapter.
- If a SIMM fails, the slot number of the failing SIMM may be indicated by keyboard LED display, but only if the SIMM belongs to bank 0 (see Figure 2-4). The other twelve SIMM Slots will be tested by the POST memory diagnostics and errors will be reported. Memory error messages on the system monitor display usually include a physical memory address

of any failing SIMM. Depending on the diagnostic program you are running and the SunOS release loaded, a SIMM slot number may be displayed. See “Determining Faulty SIMM Locations” earlier this chapter. Replace the defective SIMM. See “Single Inline Memory Modules (SIMMs)” earlier in this chapter.

- If NVRAM (or TOD or Battery) fails, replace the NVRAM. See “NVRAM/TOD” later in this chapter.
- If the main logic board fails, replace the main logic board. See “Removing the Main Logic Board” and “Replacing the Main Logic Board” later in this chapter.
- If you see nothing on the display, and the system appears dead, replace the main logic board. See “Removing the Main Logic Board” and “Replacing the Main Logic Board” later in this chapter.

19. At the > or ok prompt, turn off the system’s power switch.

20. Reconnect the power and data cables to the hard disk drives and the diskette drive.

See Figures 4-17 and 4-19 in this chapter for the location of the data and power cables.

21. Replace the system unit’s cover.

See “Replacing the System Unit’s Cover” towards the end of this chapter.

22. If you have identified the problem, go to step 22.

If you have not identified the problem, go to next step.

23. Turn the system and the terminal on and run the Diagnostic Executive with the cache disabled *only if all POST tests passed*.

If any of the Diagnostic Executive tests fail, replace the part indicated by the test. The Diagnostic Executive is an independent operating system. It runs exhaustive subsystem tests independent of the SunOS Operating System. See the *SunDiagnostic Executive User’s Guide for SPARC Desktop Systems*.

24. At the > or ok prompts, turn off the system’s power switch.

25. Disconnect the terminal and reconnect the graphics monitor and the Ethernet connector.

To reconnect the graphics monitor see “Installing Your Monitor” in Appendix C of the *SPARCstation 2 Installation Guide*.

This completes the procedure.

Removing the Main Logic Board

This section explains how to remove the main logic board from the system unit.

To remove the main logic board:

- 1. Removing and replacing the main logic board is a drastic step to take.**
See “Before Replacing the Main Logic Board” for troubleshooting information.
- 2. Read the parts of Chapter 3 about how to halt your system, tools needed, removing expansion units, removing the system unit’s cover and attaching a wrist strap.**
- 3. Check that the green LED at the front of the chassis is not lit.**
- 4. Check that the fans are not running.**
- 5. Check that the system’s power cord remains connected to the system and the wall outlet.**
- 6. Disconnect all of the cables from the connectors on the rear of the system unit.**
- 7. Place an anti-static mat shiny side up next to the system unit.**
- 8. Remove the SBus boards.**
See “SBus Boards” earlier in this chapter. Place the SBus boards on the anti-static mat.
- 9. Remove the SIMMs from their sockets.**
Note the slots they were originally installed into. Place the SIMMs on the antistatic mat.
- 10. Disconnect the 12-pin power supply cable from the (J0701) connector in the right front corner of the main logic board (see Figures 4-25 and 4-26).**
- 11. Disconnect the LED/speaker assembly cable (J0602) from the connector in the right front corner of the main logic board (see Figures 4-25 and 4-26).**
- 12. Disconnect the 34-line diskette data (J0501) and power cables (J0704) from the connectors on the main logic board (see Figures 4-27 and 4-26) and fold them out of the way.**

- 13. Disconnect the hard disk drive data (J0401 and J0402) and power cables (J0702 and J0703) from the data and power connectors on the main logic board (see Figures 4-25 and 4-26).**
Fold them out of the way.
- 14. With an IC extractor or a small flat-bladed screwdriver, remove the NVRAM chip (see Figure 4-25 and Table 4-3 for the location of the NVRAM chip) from its socket slowly and evenly.**
- 15. Store the NVRAM chip in conductive foam or place it on the antistatic mat to prevent damage from electrostatic discharge.**
Save the NVRAM chip for re-use.
- 16. Remove the two Phillips head screws that secure the board to the back panel (see Figure 4-26).**
- 17. Slide the main logic board toward the front of the chassis to release it from the five standoffs in the bottom of the chassis.**
- 18. Grasp the board by the SBus slot connectors with both hands and carefully lift it out of the chassis.**
Avoid handling any of the delicate electronic components or touching any of the main logic board's traces.
- 19. Place the main logic board on the anti-static mat.**

Preparing Main Logic Board for Replacement

This section explains how to prepare the main logic board for replacement.

To prepare a main logic board for replacement:

- 1. Remove the NVRAM chip from the replacement main logic board and place it on the anti-static mat.**
- 2. Insert the NVRAM from the defective board in the replacement board at the same location.**

Match the pin 1 indicator on the NVRAM chip with the indicator on the socket. Holding the NVRAM chip at the edges, carefully align the pins and insert the NVRAM chip in the socket. Figure 4-25 and Table 4-3 show the location of the NVRAM chip on the main logic board.

Replacing the Main Logic Board

This section explains how to replace the main logic board into the system unit.

To replace the main logic board:

- 1. Insert the connectors on the rear of the replacement board into the back panel as shown in Figure 4-26.**
- 2. Align the board so that the five tapered mounting holes align with the standoffs in the bottom of the chassis.**
After the board is properly aligned, slide it back toward the rear bezel until the standoffs lock into the mounting holes.
- 3. Install two Phillips head screws to secure the main logic board to the rear of the chassis (see Figure 4-26).**
- 4. Connect the 12-pin power cable from the power supply to connector J0701 (see Figures 4-25 and 4-26) in the right front corner of the main logic board.**
- 5. The connector is keyed so that the power cable will fit only one way.**
- 6. Connect the 34-line diskette drive data and power cables to the connectors on the main logic board (see Figure 4-26).**
The data cable connector is J0501 and the power connector is J0704 (see Figure 26).
- 7. The connectors are keyed so they will fit only one way.**
- 8. Connect the hard disk drive data and power cables to the data and power connectors on the main logic board (see Figures 4-25 and 4-26).**
Drive 1 data cable is J0402, and drive 1 power cable is J0703. Drive 2 data cable is J0401, and drive 2 power cable is J0702
- 9. The connectors are keyed so that they will only fit one way.**
- 10. Connect the LED/Speaker cable assembly to connector J0602 in the right front corner of the main logic board (see Figures 4-25 and 4-26).**
- 11. Re-install the SIMMs into their original sockets.**
See “SIMMs” earlier in this chapter for the correct locations.

Note – Bank 0 must be filled with SIMMs or the system will not pass its power-on self test.

- 12. Re-install the SBus boards as directed in “SBus Boards” earlier in this chapter.**
- 13. Connect all of the cables to the ports at the rear of the system unit.**
- 14. Replace the system unit’s top cover.**
See “Replacing the System Unit’s Cover” later in this chapter.
- 15. Turn the system unit’s power on, and check for proper system operation.**
See “How to Turn the Power Back On” at the end of this chapter.

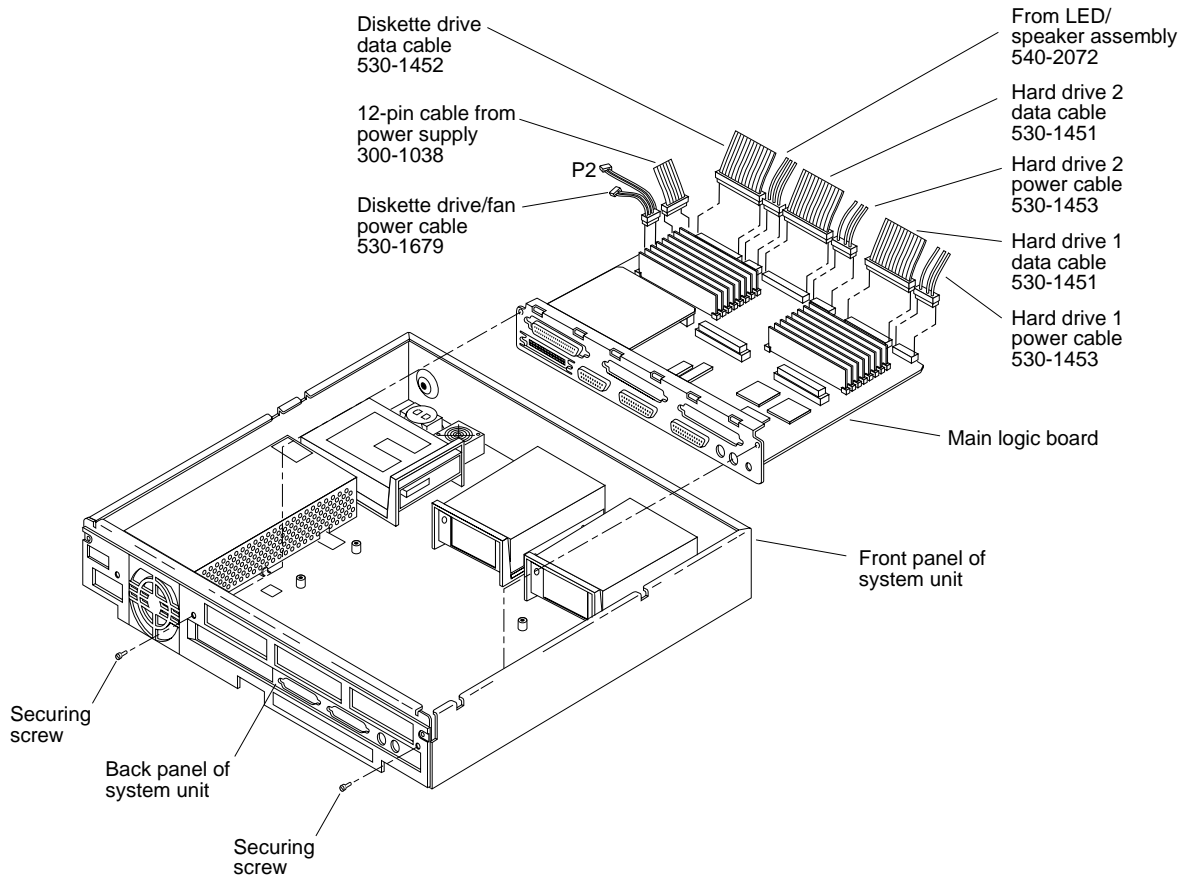

Figure 4-26 Removing and Replacing the Main Logic Board

Boot PROM

This section explains how to remove and replace the boot PROM on the main logic board.

To remove and replace the boot PROM, follow these steps:

1. Before removing and replacing the boot PROM, you should have verified that the boot PROM needs to be replaced.

See “Before Replacing the Main Logic Board” earlier in this chapter before continuing. The procedure described in that section explains how to run POST and the Diagnostic Executive.

2. Read the parts of Chapter 3 about how to halt your system, tools needed, removing expansion units, removing the system unit’s cover and attaching a wrist strap.

3. Check that the green LED at the front of the chassis is not lit.

4. Check that the fans are not running.

5. Check that the system’s power cord remains connected to the system and the wall outlet.

6. Remove the SBus boards from SBus slots 1 and 2.

See “SBus Boards” earlier in this chapter.

7. Locate the boot PROM (see Figures 4-25 and 4-26). Remove the boot PROM.

To do this use an IC extractor or a small flat-bladed screwdriver and remove the PROM from its socket slowly and evenly.

8. Insert the new boot PROM in the socket.

To do this, match the pin 1 indicator on the boot PROM with the indicator on the socket. Holding the boot PROM at the edges, carefully align the pins and insert the boot PROM in the socket. Note that inserting the chip backwards will damage the chip.

9. Replace the SBus boards in the system unit.

See “SBus Boards” earlier in this chapter.

10. Replace the system unit’s cover.

To do this, see “Replacing the System Unit’s Cover” towards the end of this chapter.

11. Re-run the POST test again to determine if the new boot PROM solved the problem.

See “Before Replacing the Main Logic Board” earlier in this chapter.

NVRAM/TOD

There is a lithium battery within the NVRAM/TOD (Time of Day) chip. The NVRAM chip is located to the right of the boot PROM (see Figures 4-25 and 4-28). You must remove the NVRAM chip from the main logic board you are replacing and install it in the new main logic board. For more information see “Replacing the Main Logic Board”.

To remove and replace the NVRAM/TOD chip, follow these steps:

1. Before removing and replacing the NVRAM/TOD chip, you should have verified that the NVRAM/TOD chip needs to be replaced.

See “Before Replacing the Main Logic Board” earlier in this chapter before continuing. The procedure described in that section explains how to run POST and the Diagnostic Executive.

2. Read the parts of Chapter 3 about how to halt your system, tools needed, removing expansion units, removing the system unit’s cover and attaching a wrist strap.

3. Check that the green LED at the front of the chassis is not lit.

4. Check that the fans are not running.

5. Check that the system’s power cord remains connected to the system and the wall outlet.

6. Remove the SBus boards from SBus slots 1 and 2. See “Removing SBus Boards” in this chapter.

7. Locate the NVRAM/TOD chip (see Figures 4-25 and 4-26). Remove the NVRAM/TOD chip.

To do this use an IC extractor or a small flat-bladed screwdriver and remove the NVRAM/TOD chip from its socket slowly and evenly.

8. Insert the new NVRAM/TOD chip in the socket.

To do this, match the pin 1 indicator on the NVRAM/TOD chip with the indicator on the socket. Holding the NVRAM/TOD chip at the edges, carefully align the pins and insert the NVRAM/TOD chip in the socket. Note that inserting the chip backwards will damage the chip.

9. Replace the system unit's cover.

To do this, see “Replacing the System Unit's Cover” towards the end of this chapter.

Re-run the POST test again to determine if the new NVRAM/TOD chip solved the problem. See “Before Replacing the Main Logic Board” earlier in this chapter.



Warning – There is a lithium battery molded into the Mostek real-time clock, No. MK48T02BU or No. MK48T02B-XX, where X may be any number from 1-9. It is located on the main logic board of the system unit next to the boot PROM. The battery may explode if mistreated. Do not disassemble it or attempt to recharge it.

Speaker

The speaker is mounted at the front of the system on the right hand side (see Figure 4-1). There are two parts to the speaker: the LED/speaker assembly and the speaker clip. See Appendix B “Illustrated Parts Breakdown” for an illustration of the speaker parts.

To test if the speaker assembly needs to be replaced:

1. **Read the parts of Chapter 3 about how to halt your system, tools needed, removing expansion units, removing the system unit's cover and attaching a wrist strap.**
2. **Turn the power on.**
Connect the power cord to the system and the wall outlet. The power is required to measure the voltage on the LED pin later on.
3. **Check that the green LED at the front of the chassis is lit.**
4. **Check that the fans are running.**
5. **Locate the speaker assembly (see Figure 4-1).**

6. Measure the voltage on the LED pin of the speaker connector by using a VOM

If the voltage measured is 0 V, the LED will not light. Replace the main logic board. See “Removing the Main Logic Board” and “Replacing the Main Logic Board” earlier in this chapter. If at least +5 V is measured on the LED pin of the connector and the LED does not light, the LED is bad. Replace the LED/speaker assembly as directed in the following procedures.

7. Test if sound is heard when sound is being sent to the speaker. Replace the system unit’s cover.

To do this see “Replacing the System Unit’s Cover” later in this chapter.

8. Bring up the system and boot the SunOS Operating System.

To do this, see “Booting Your System” in Chapter 1 of the *Sun System & Network Manager’s Guide*.

9. Generate sound through the speaker by entering either of the following:

```
% cat /usr/demo/sound/sample.au > /dev/audioThe system plays back a spoken message  
or
```

```
% cat /vmunix > /dev/audioThe system plays back garbage, which is louder  
Press Control-C to abort the message
```

10. Replace the speaker assembly as directed in the following procedures, if either of the sound tests fail.

If either of the sound tests pass, do not replace the speaker. Replace the LED/speaker assembly or the main logic board only if the LED does not light (see step 3).

To remove the speaker, follow these steps:

- 1. Read the parts of Chapter 3 about how to halt your system, tools needed, removing expansion units, attaching a wrist strap, and removing the system unit's cover.**
- 2. Check that the green LED at the front of the chassis is not lit.**
- 3. Check that the fans are not running.**
- 4. Check that the system's power cord remains connected to the system and the wall outlet.**
- 5. Locate the speaker assembly and its 4-pin connector (J0602) at the front right corner of the main logic board (see Figure 4-25).**
- 6. Unplug the 4-pin connector from the main logic board.**
- 7. Push the spring-loaded clip on the speaker clip.**
Slide it forward and lift out the speaker assembly and the attached speaker clip.
- 8. Pull the LED out of its mounting clip.**
- 9. To replace the speaker, follow these steps:**
- 10. Push the replacement LED into the mounting clip.**
- 11. Slide the speaker assembly and the attached speaker clip into its catch and push it down.**
- 12. Plug the 4-pin connector onto the J0602 connector on the main logic board.**
The connector is keyed so it will fit only one way.
- 13. Replace the system unit's top cover.**
See "Replacing the System Unit's Cover" later in this chapter.
- 14. Turn the system unit's power on, and check for proper operation of the system unit and the replaced speaker.**
See "How to Turn the Power Back On" towards the end of this chapter.

Replacing the System Unit's Cover

To replace the system unit's cover:

1. **Hold the cover at an angle of approximately 30 degrees in relation to the system unit chassis with the front end down and the back end up.**
2. **Gently guide the plastic tabs on the front of the cover into the tab slots on the front of the chassis (see Figure 4-27).**
Continue to hold the cover with your hands.



Caution – Holding the cover at angles greater than 30 degrees can prevent insertion of the tabs into the tab slots. Once the tabs are in the slots, raising the cover to angles greater than 30 degrees can break the tabs.

3. **Slowly lower the cover onto the chassis, and be sure the security loop clears the diskette drive (if equipped) and seats into the security loop slot on the bottom of the chassis.**
4. **Insert the two screws that hold the top cover to the back panel.**
5. **Tighten the two screws with a screwdriver**

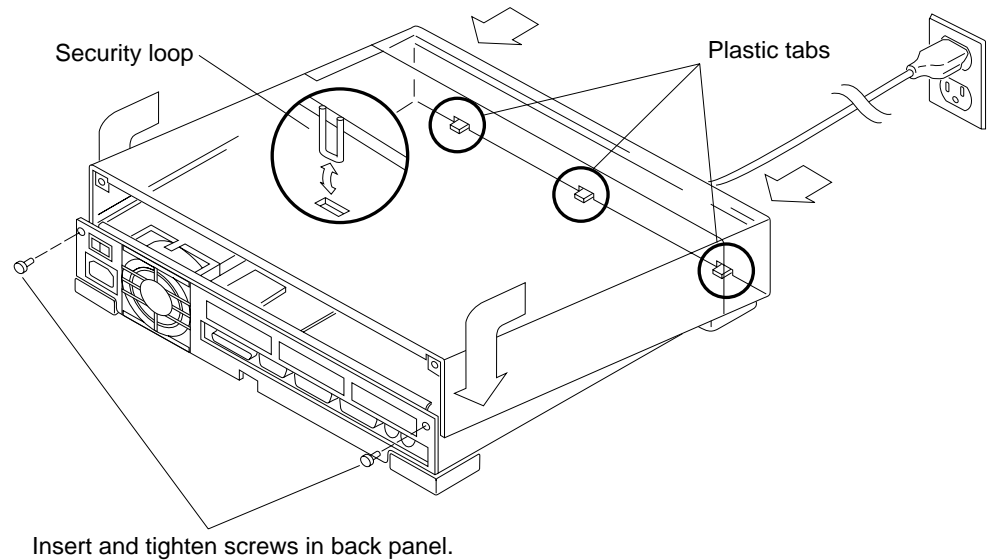

Figure 4-27 Replacing the System Unit's Cover

Connecting the Desktop Storage Pack

To connect the Desktop Storage Pack (DSP) to the system unit:

1. **Connect the connector on the SCSI cable to the SCSI port on the system unit's back panel.**
2. **See the "Desktop Storage Pack Installation Guide" for additional installation information.**

Connecting the External Storage Module

To connect the External Storage Module (ESM) to the system unit, follow these steps:

1. **Connect the SCSI connector on the SCSI adapter cable to the SCSI port on the system unit's back panel.**
2. **See the "Sun External Storage Module" for additional installation instructions.**

Video Monitors

There are several different types of monitors and cabling. The color and grayscale monitors use cables with 13W3 connectors. See Appendix C of the *SPARCstation 2 Installation Guide* for more specific information on monitors and monitor cables.

Mouse

The optical mouse connects to one of two jacks in the back of the keyboard. The mouse can be connected on either the left or right side to accommodate either left-handed or right-handed users. Connect the mouse to the keyboard before you connect the keyboard to the system unit.

Keyboard

A cable connects the keyboard to the system unit. The keyboard port is located at the left rear of the system unit (when viewed from the front). Connect the keyboard cable on either the left or right side of the keyboard, then to the port on the back of the system unit.

How to Turn the Power Back On

After turning off the power to replace FRUs, turning the power on again is relatively simple.



Warning – This device is equipped with a 3-wire grounded power cord. To reduce the risk of electrical shock, always plug the power cord into a properly grounded power outlet.



Caution – Always allow 10 seconds between turning off the power and turning it back on again. This pause prevents possible damage to power supply components in your system unit.

Turn the power switches on in this order:

- Monitor
- External drive (if you have one)
- System Unit

After a minute or so, you should see the login prompt.

```
system messages
system messages
system messages
system messages
system messages
system messages
system messages
system messages
system messages
system messages

hostname login:
```

When you see the login screen, you can log in to your system. For more information on logging in, see Chapter 2 of the *Sun System User's Guide*.

System Specifications



This appendix contains system specifications, including dimensions, electrical and power requirements, environmental requirements, and compliance with electrical and safety regulations.

Regulatory Compliance

Table A-1 lists regulatory compliance information.

Table A-1 Regulatory Compliance Information

PRODUCT SAFETY	UL 478 CSA C22.2 No. 154 IEC 380
EMI	FCC Class B VDE Class B DOC Class B
ERGONOMICS	German Federal Republic ZH 1/618
X-RAY EMISSIONS	DHHS, PTB

Input Power Requirements

Table A-2 lists the input power requirements for the system unit. The maximum power dissipated is less than or equal to 120 watts. The power supply automatically selects the correct AC voltage range.

Table A-2 Input Power Requirements and Power Dissipation for the System Unit

Operating Voltage Range	Maximum Input Current	Maximum Input Power	Maximum Input Volt-Amps	Thermal Dissipation	Operating Frequency Range
87.5-132 Vac	2.1 Amps	119 Watts	179	406 BTU	47-63 Hz
180-264 Vac	1.2 Amps	119 Watts	179	406 BTU	47-63 Hz

Environmental Requirements

Table A-3 lists the environmental requirements for the operating environment and the non-operating environment.

Table A-3 Table of Environmental Requirements

Operating Environment:

Temperature	between 0 to 40 degrees C (32 and 104 degrees F)
Humidity	5 to 80% relative noncondensing at 40 degrees C (104 degrees F)
Wet Bulb	25 degrees C (77 degrees F) maximum
Altitude	0 to 3,048 m (0 to 10,000 ft)
Vibration	5-22 Hz, 0.01 inches p-p; 22-500 Hz, 0.25 g p-p
Shock	5 g pk, 10 msec 1/2 sine wave

Non-Operating Environment:

Temperature	between -20 to 75 degrees C (-4 to 167degrees F)
Humidity	5 to 90% relative noncondensing at 40 degrees C (104 degrees F)
Wet Bulb	46 degrees C (115 degrees F) maximum
Altitude	0 to 12,192 m (0 to 40,000 ft)
Vibration	5-22 Hz, 0.02 inches p-p; 22-500 Hz, 0.5 g p-p
Shock	20 g pk, 30 msec

Physical Specifications

Table A-4 lists the physical specifications for the system unit, the keyboard, the optical mouse, and selected monitors.

Table A-4 Table of Physical Specifications

Component	Height	Width	Depth	Net Weight
System Unit	2.8 in (7.1 cm)	16 in (40.9 cm)	16 in (40.9 cm)	25 lbs (11 kg)
Keyboard	2 in (5 cm)	19 in (48 cm)	8 in (20 cm)	2 lbs (1 kg)
Mouse	2 in (5 cm)	4 in (10 cm)	3 in (8 cm)	0.3 lbs (0.14 kg)
Monitor, 16 in color	15.8 in (40 cm)	15.5 in (39.4 cm)	17.3 in (43.8 cm)	70 lbs (31.8 kg)
Monitor, 17 in grays	14.5 in (36.7 cm)	16.1 in (40.9 cm)	15.6in (39.5 cm)	37 lbs (16.8 kg)
Monitor, 19 in color	17.4 in (44.2 cm)	18.4 in (46.7 cm)	20.6 in (52.3 cm)	75 lbs (34.1 kg)
Monitor, 19 in grays	17.5 in (44.5 cm)	18.1 in (46.0 cm)	15.9 in (45.2 cm)	52 lbs (23.6 kg)



Illustrated Parts Breakdown



This appendix illustrates how to connect the system's component parts and presents global views of the system.

Parts Breakdown

Figure B-1 illustrates system interconnection. Table B-1 gives part numbers of the system components. Figure B-2 shows exploded view of the system unit. Figure B-3 illustrates exploded view of the system unit showing drive brackets. Figure B-4 shows exploded view of main logic board in the system unit.

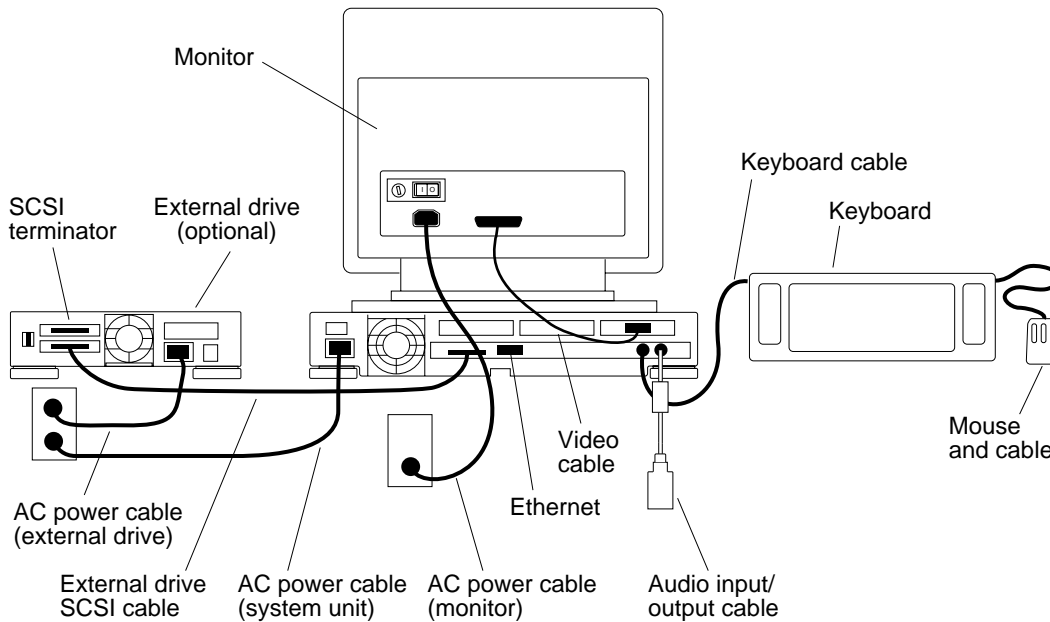

Figure B-1 System Interconnection

Table B-1 System Components and Their Part Numbers

Component	Part Number
Color Video Cable Adapter	530-1446
Keyboard cable	530-1442 or 530-1443
Keyboard	320-1005
Video cable	530-1440 or 530-1509
Grayscale Video Cable Adapter	530-1511
AC power cable (monitor)	180-1146 (115 V) or 180-1125 (240 V)
Mouse and Mousepad	370-1170 and 370-1368
Monitors	See "Video Monitors" in Chapter 4
AC power cable (system unit)	180-1179, 180-1177, 180-1178, 180-1176, 180-1097

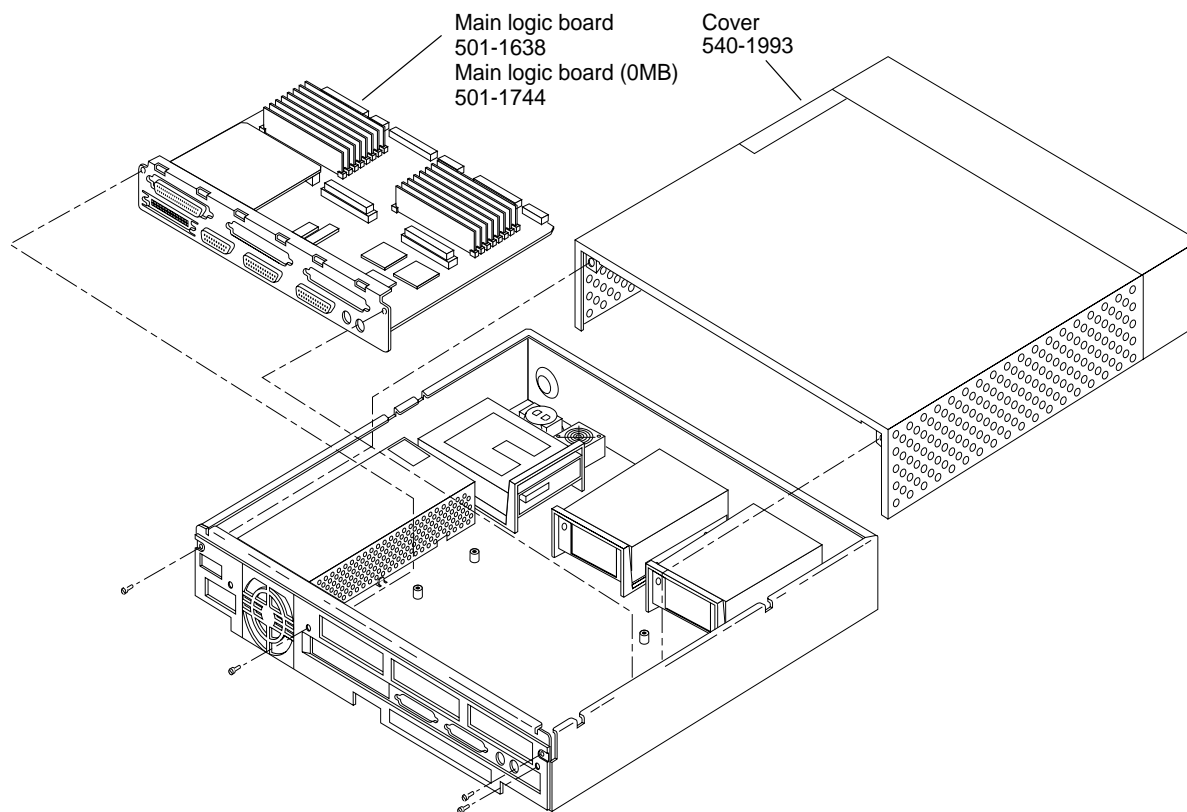

Figure B-2 Exploded View of the System Unit

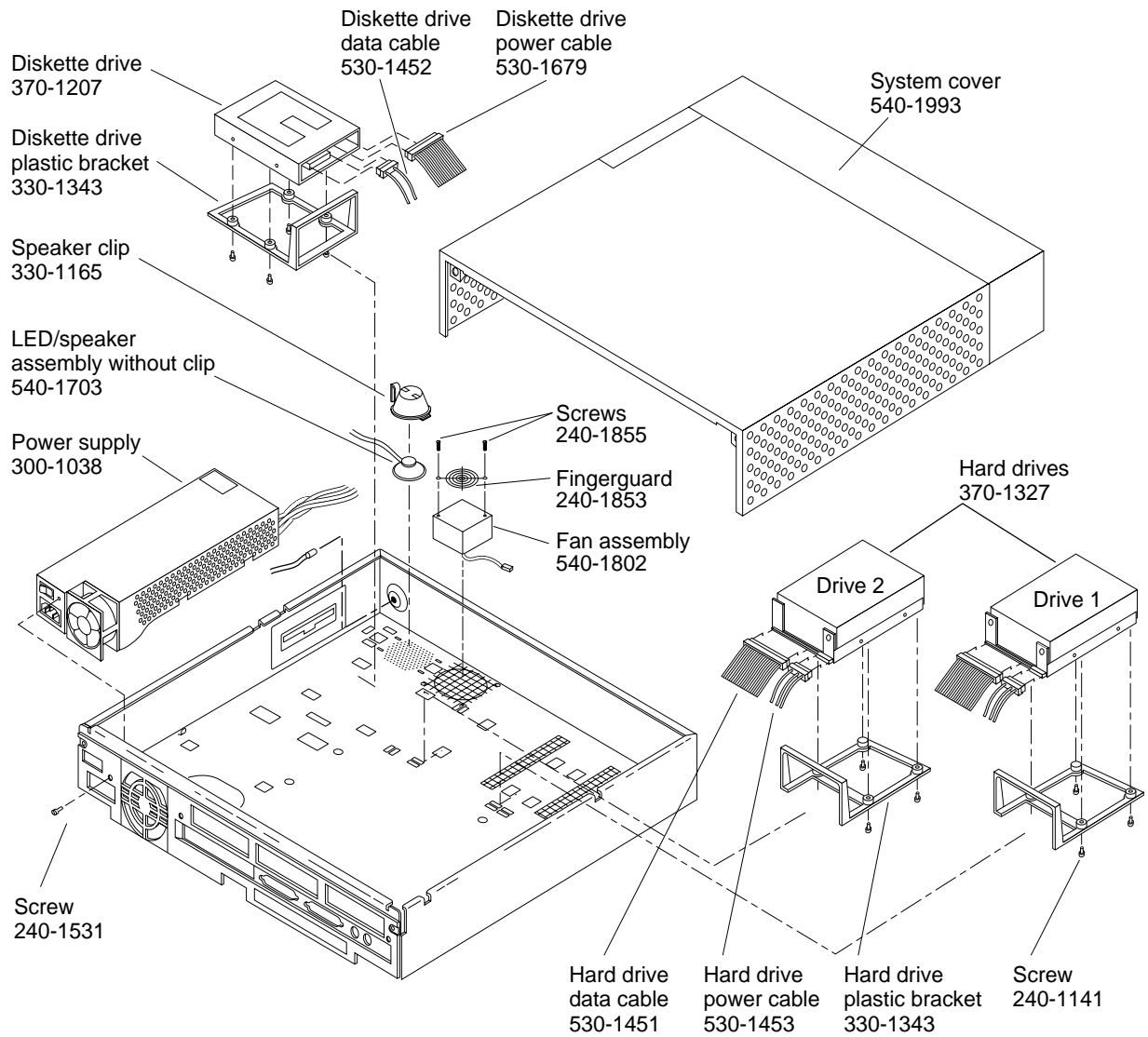

Figure B-3 Exploded View of the System Unit Showing Drive Bracket

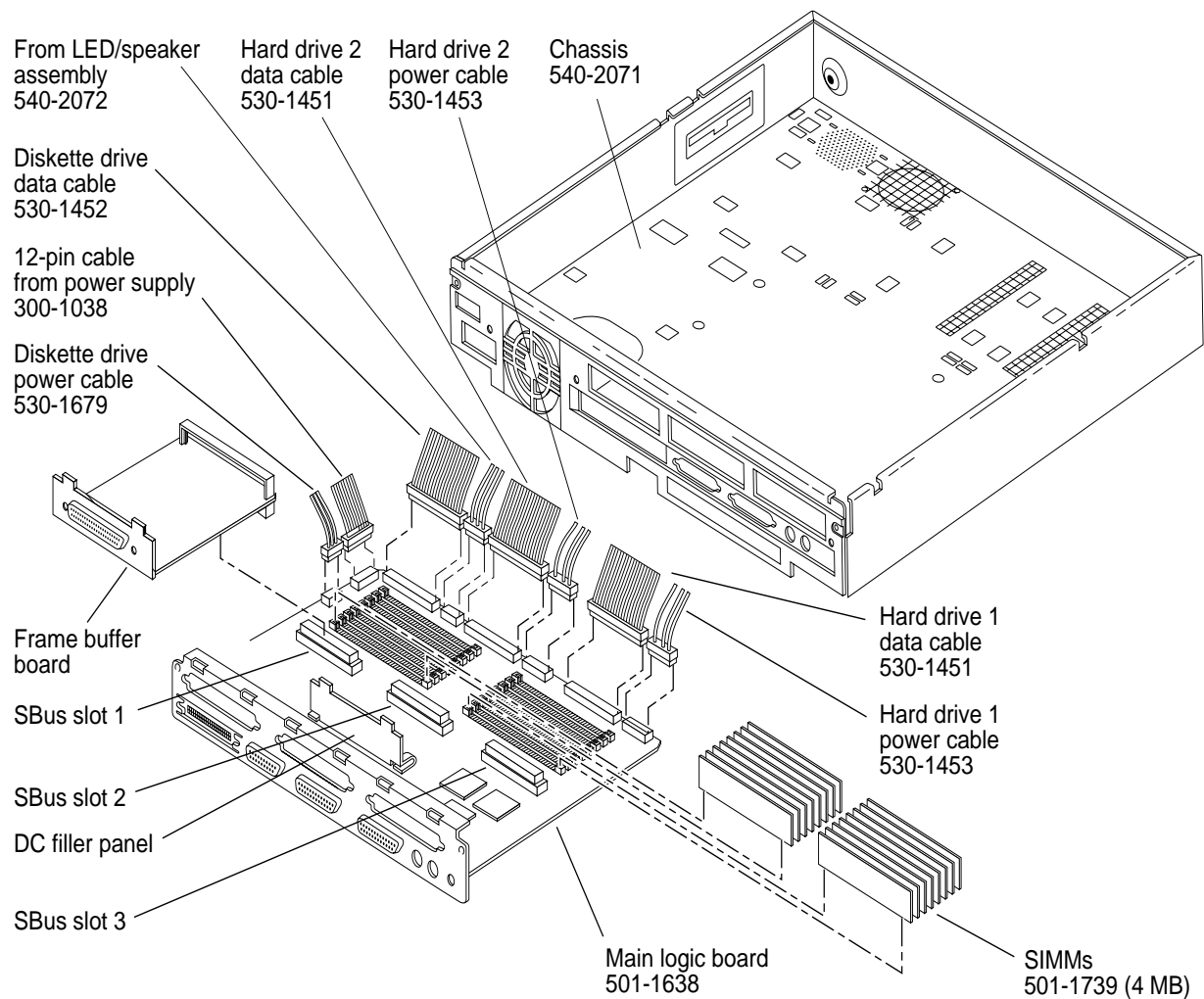

Figure B-4 Exploded View of the Main Logic Board in the System Unit



FRU List



FRU List

This appendix lists the part number and description of each FRU for the SPARCstation 2.

Table C-1 lists the FRU by field replaceable unit, part number and description.

Table C-1 FRU List (continued on next page)

Field Replaceable Unit	Part Number	Description
Main Logic Board	501-1638	Main Logic Board
	501-1744	Main Logic board, 0 MB
SIMM	501-1739	4 MB SIMM
NVRAM	525-1112	NVRAM (Battery)
EPROM	525-1107	EPROM, 32 Pin DIP (Boot PROM)
SBus Board	370-1370	GS Graphics Accelerator Board
	501-1645	GX Graphics Accelerator Board
	501-1672	Lego SC Graphics Accelerator Board
	501-1718	Color Frame Buffer Board
	501-1561	1-Bit Analog Frame Buffer Board



Field Replaceable Unit	Part Number	Description
Power Supply	300-1038	Power supply, 85 W
Hard Disk Drive	370-1327	207 MB, 3 1/2" (90 mm) Disk Drive
Diskette Drive	370-1207	1.47 MB, 3 1/2" Disk, Floppy
LED/Speaker Assembly and Clip	540-2072	LED Speaker Assembly
Fan Assembly	540-1802	Fan Assembly
Screw (for fan assembly)	240-1855	SEMs M3.5 25 mm Phillips Hd, Zn
Video Monitor	365-1095	19" (483 mm) Sony Color, 115/230 V
	365-1099	19" (483 mm) Grayscale, 115/230 V
	365-1100	17" (432 mm) Grayscale, 115/230 V
	365-1113	16" (407 mm) Sony Color, 115-230 V
Keyboard	320-1005	Keyboard, Type 4
Mouse	370-1170	Mouse, SUN-4, CIR DIN Tail
Mouse Pad	370-1368	Mouse pad 7"x7 3/4", 200D
Cable	530-1440	Video Cable 4 ft. (1.2 m)
	530-1451	Hard Disk Drive Data Cable
	530-1452	Diskette Drive Data Cable
	530-1453	Hard Disk Drive Power Cable
	530-1509	Video Cable 14.8 ft. (4.5 m)
	530-1679	Fan/Diskette Drive Power Cable ("Y" Power Cable)

Open Boot PROM



This appendix contains the Table of Alias and Boot Paths, and the Non-Volatile Random Access Memory (NVRAM) parameters used during reset.

Open Boot PROM

In comparison with the SPARCstation 1+ and the SPARCstation IPC, the SPARCstation 2 has different boot paths. See Table D-1 for details. Table D-2 shows the value and default value for each of the NVRAM parameter.

*Table D-1*

Table of Alias and Boot Paths

Alias	SPARCstation 2 Boot paths	SPARCstation 1+ and IPC Boot Paths
disk0	/sbus/esp/sd@3,0	sd(0,0,0)
disk1	/sbus/esp/sd@1,0	sd(0,1,0)
disk2	/sbus/esp/sd@2,0	sd(0,2,0)
disk3	/sbus/esp/sd@0,0	sd(0,3,0)
tape0	/sbus/esp/st@4,0	st(0,0,0)
tape1	/sbus/esp/st@5,0	st(0,1,0)
cdrom	/sbus/esp/sd@6,0:c	sd(0,6,2)
net	/sbus/le	le



Table D-1 Table of NVRAM Parameters

NVRAM Parameter Name	Value	Default Value
name	options	options
selftest-#megs	1	
oem-logo		
oem-logo?	false	false
oem-banner		
oem-banner?	false	false
output-device	screen	screen
input-device	keyboard	keyboard
sbus-probe-list	0123	0123
scsi-initiator-id	7	7
keyboard-click?	false	false
keymap		
diag-file		
diag-device	net	net
boot-file		
boot-device	disk	disk
auto-boot?	true	true
watchdog-reboot?	false	false
fcode-debug?	false	false
use-nvramrc?	false	false
nvramrc		
screen-#columns	80	80
screen-#rows	34	34
sunmon-compat?	true	true
security-mode	none	none
security-password		
security-#badlogins	0	
ttyb-rts-dtr-off	false	false
ttyb-mode	9600,8,n,1,-	9600,8,n,1,-
ttyb-ignore-cd	true	true
ttya-rts-dtr-off	false	false
ttya-mode	9600,8,n,1,-	9600,8,n,1,-
ttya-ignore-cd	true	true
hardware-revision		
last-hardware-update		
testarea	85	0
mfg-switch?	false	false
diag-switch?	true	true



Glossary

A RMS

Amperes root mean square. RMS is often used in power measurements for electronic equipment.

board

See *printed circuit board*. In the SPARCstation 2, a board occupies one or more SBus slots.

boot

To load the system software into memory and start it running.

boot PROM

A term referred to for the PROM chip on the main logic board. This chip contains boot code consisting of a Forth Monitor program. The boot PROM is connected to the I/O data bus.

boot PROM diagnostics

The diagnostic firmware contained in the boot PROM. These diagnostics include the Power-On Self-Test (POST) and on-board diagnostics.

buffer

The auxiliary data-storage device which holds data temporarily and which may also perform other functions in conjunction with various I/O machines.

cache

A buffer type of high-speed memory that is filled at medium speed from main memory, often with instructions and programs.

card	See <i>printed circuit board</i> .
CPU	Central Processing Unit.
Desktop Backup Pack	An external unit containing a tape drive that can be connected to a SPARCstation 2.
Desktop Disk Pack	An external unit containing a disk drive that can be connected to a SPARCstation 2.
Desktop Storage Pack (DSP)	A generic name for an external unit containing a tape drive, a disk drive, or a CD-ROM drive that can be connected to a SPARCstation 2. The external unit containing the tape drive is referred to as the Desktop Backup Pack. The external unit containing a disk drive is specifically referred to as the Desktop Disk Pack. The external unit containing a CD-ROM drive is specifically referred to as the Desktop SunCD Pack.
Desktop SunCD Pack	An external unit containing a CD-ROM drive.
Diagnostic Executive	See <i>SunDiagnostic Executive</i> .
DMA	Direct Memory Access.
DRAM	Dynamic Random Access Memory.
ESM	External Storage Module. An external unit that contains disk and/or tape drive(s) that can be connected to a SPARCstation 2.
Forth	A high-level programming language. A major feature of Forth is that user-defined operators can be used as if they are primitives.

Forth Toolkit

An interactive command interpreter based on the Forth programming language. While in the Toolkit, you will see the `ok` prompt. The Toolkit gives you access to an extensive set of functions for performing fault isolation and debugging.

frame buffer board

A printed circuit board installed in an SBus slot of the system unit that controls a video display.

FRU

Field-replaceable unit.

IC

Integrated Circuit.

ID

Identification.

I/O

Input/Output. For example, an input/output device.

IU

Integer Unit.

LANCE

Local Area Network Controller for Ethernet.

LED

Light Emitting Diode.

Monitor 1)

Indicated by the `>` prompt. From the `>` prompt, you can boot the system, continue the execution of a halted program, or enter the Forth Toolkit. If disaster befalls your operating system, the Monitor automatically starts.

Monitor 2)

A video display unit that is part of the SPARCstation 2. It is not the same thing as a terminal.

MMU

Memory Management Unit.

NVRAM

Non-Volatile RAM.

On-Board Diagnostics

Is a test that allows you to test the control registers, the network controller, the diskette drive system, memory, the cache, the system clock, and watch the network for valid packets

Por

Power-On reset TTL open collector signal from the power supply, which is activated after DC voltages have risen.

POST

Power-On Self-Test. The POST runs automatically when you turn on the system's power switch or reboot the system. The POST, stored in the boot PROM, is a series of rudimentary tests designed to verify that a viable boot path exists for loading more extensive diagnostic software, such as the Diagnostic Executive.

printed circuit board

Any board with electronic wiring etched on it.

PROM

Programmable Read Only Memory.

RAM

Random Access Memory.

ROM

Read Only Memory.

SBus board

A printed circuit board installed in an SBus slot of the system unit.

security loop

An internal metal loop used in conjunction with the lock block to provide protection from unwanted system access.

SCC

Serial Communications Controller.

SCSI

Small Computer System Interface.

SIA

Serial Interface Adapter.

SIMM

Single Inline Memory Module. This is a small printed circuit board that contains RAM chips.

SunDiagnostic Executive

An independent operating system running exhaustive subsystem tests independent of SunOS. Use the SunDiagnostic Executive after you have run POST and need to troubleshoot which FRU needs to be replaced.

Sundiag System Exerciser

Diagnostic software that runs under SunOS; displays real-time use of system resources and peripheral equipment such as Desktop Storage Packs and External Storage Modules.

system Monitor

See *Monitor 1) or 2)*.

terminal

A device that consists of a video display and keyboard that is used to type and display information. A terminal may be connected to either of the RS-423/RS-232 serial interface ports on the back panel of the SPARCstation 2. It is not the same thing as a monitor.

TOD

Time of Day clock.

UART

Universal Asynchronous Receiver/Transmitter.

VRAM

Virtual Random Access Memory.

wrist strap

A device that provides grounding for static electricity between your body and the system unit's chassis. Electric current and voltage do not pass through the wrist strap.

Index

Symbols

> prompt 31

Numerics

1-bit analog frame buffer board 15, 55

A

alias and boot paths 116
alias and booth paths 116
alias and booth paths table 116
audio 14
 chip 13
 input/output port 13
autoboot switch 21

B

backpanel 38
battery 94
block diagram
 SPARCstation 2 2
block level diagram 7
boot mode

default 21
 flowchart 20

boot PROM 3, 12
 diagnostics 24
 removing 93
 replacing 93

boot prompt 31
bringing down the system 33

C

cache memory 9
chassis 1
Color Frame Buffer Board 14, 54
component parts 3
components 3, 8
connector
 power supply 80
cover
 removing 37
 replacing 98
CPU 3, 9
 preparing for replacement 89

-
- CPU board 75
 - removing 88
 - replacing 90
 - test points 79
 - troubleshooting 83
 - CPU core 9
 - D**
 - default boot mode 21
 - flowchart 20
 - Desktop Backup Pack 8, 15
 - Desktop Disk Pack 8, 15
 - Desktop Storage Pack
 - connecting 99
 - disconnecting 36
 - Desktop SunCD Pack 8, 15
 - determining faulty SIMM locations 46
 - determining which FRU needs to be replaced 31
 - devices
 - eight-bit 12
 - Diagnostic Executive 21, 31
 - diagnostic tools
 - overview 21
 - summary 22
 - diagnostics
 - boot PROM 24
 - determining defective FRUs 31
 - on-board 29
 - overview 21
 - when to use 22
 - diagram
 - block, SPARCstation 2 2
 - disk drive 15, 60
 - preparing 62
 - removing 61
 - replacing 66
 - diskette drive 3, 16, 68
 - controller 13
 - controller chip 11
 - removing 69
 - replacing 71
 - DMA 11
 - DRAM 11
 - drive
 - disk
 - preparing 62
 - removing 61
 - replacing 66
 - diskette
 - removing 69
 - replacing 71
 - units 8
 - DSP
 - disconnecting 36
 - dynamic RAM 11
 - E**
 - eight-bit devices 12
 - environmental requirements 104
 - ESM
 - disconnecting 36
 - Ethernet 11
 - board 14
 - controller chip 11
 - expansion modules 8, 15
 - disconnecting 36
 - expansion units 8, 15
 - external drive units 8
 - External Storage Module 15

-
- connecting 99
 - disconnecting 36
- F**
- fan assembly 72
 - removing 73
 - replacing 74
 - field replaceable units
 - identification 42
 - replacement 41
 - field-replaceable units
 - boards and module 42
 - floating-point coprocessor 3
 - floating-point unit 9
 - floppy disk drive 16, 68
 - controller 13
 - controller chip 11
 - removing 69
 - replacing 71
 - Forth Toolkit 31
 - FPU 9
 - Frame Buffer Board 14
 - frozen system 35
 - FRU
 - identification 42
 - replacement 41
- G**
- graphics I/O devices 17
 - GS Graphics Accelerator Board 15, 55
 - GX Graphics Accelerator Board 14
- H**
- halt command 34
 - halting the system 33
 - hard disk drive 3, 15, 60
 - preparing 62
 - removing 61
 - replacing 66
 - hung system 35
- I**
- input power requirements 104
 - input/output 11
 - integer unit 9
 - interior
 - system unit 3
 - IU 9
- K**
- keyboard
 - replacing 100
 - keyboard LED 24
 - keyboard LED diagnostic code 26
 - keyboard port 13
- L**
- LANCE 11
 - LANCE controller chip 11
 - LED 95
 - lithium battery 94
- M**
- main chassis 1
 - main logic board 4, 8, 75
 - preparing for replacement 89
 - removing 88
 - replacing 90

- test points 79
- troubleshooting 83
- mass storage devices 15
- memory
 - cache 9
- memory bank 28
- memory management unit 10
- MMU 10
- Monitor 31
- monitor 17
- monitors
 - replacing 100
- mouse
 - replacing 100

N

- non-volatile RAM 3, 12
- NVRAM 3, 12, 94
- NVRAM parameter 117
- NVRAM/TOD
 - removing 94
 - replacing 94

O

- on-board diagnostics 29

P

- physical specifications 105
- port
 - keyboard 13
- ports
 - serial ports A and B 13
- POST 21, 24
- power
 - turning off 34, 35

- power supply 3, 16, 58
 - removing 58
 - replacing 59
- powering on the system 100
- Power-On Self-Test 21, 24

R

- regulatory compliance information 103
- related books xv
- replacing FRUs
 - tools needed 36

S

- SBus board
 - installing 56
 - removing 55
- SBus boards 10, 14, 54
- SBus boards and cards 14
- SBus Printer Board 15, 55
- SBus slots 10
- SCSI controller chip 11
- Second Ethernet board 55
- serial port jumpers 76
- serial ports A and B 13
- SIMM locations
 - faulty
 - determining 46
- SIMM slot locations 52
- SIMM slots 3
- SIMMs 14, 46
 - installing 50
 - removing 48, 51
- single inline memory modules 14, 46
 - removing 48, 51

sound 14
 generating 96
SPARCstation 2 block diagram 2
speaker 3, 95
 removing 97
 replacing 97
 trouble shooting 95
speaker clip 95
standalone programs 21
Sundiag system exerciser 30
SunDiagnostic Executive 31
system
 interconnection 107
 interior 3
 monitor 31
 unit 1
 unit's cover
 removing 37
 replacing 98

replacing 100

W

wrist strap
 attaching 39

T

test points 79
TOD 94
tools needed to replace FRUs 36
turning off power 34, 35
turning the power back on 100
typographical conventions xv

U

user-specified programs 21

V

Video Frame Capture Board 15, 55
video monitors

